



SmartGen
ideas for power

HMC6000A/HMC6000A 2

DIESEL ENGINE CONTROLLER

USER MANUAL



SMARTGEN (ZHENGZHOU) TECHNOLOGY CO.,LTD.



Chinese trademark

SmartGen English trademark

SmartGen – make your generator *smart*

SMARTGEN(ZHENGZHOU) TECHNOLOGY CO., LTD.

No. 28 Jinsuo Road, Zhengzhou City, Henan Province, P. R. China

Tel: +86-371-67988888/67981888/67992951

+86-371-67981000(overseas)

Fax: +86-371-67992952

Web: www.smartgen.com.cn

www.smartgen.cn

Email: sales@smartgen.cn

All rights reserved. No part of this publication may be reproduced in any material form (including photocopying or storing in any medium by electronic means or other) without the written permission of the copyright holder.

Applications for the copyright holder's written permission to reproduce any part of this publication should be addressed to SmartGen Technology at the address above.

Any reference to trademarked product names used within this publication is owned by their respective companies.

SmartGen Technology reserves the right to change the contents of this document without prior notice.

Table 1 Version History

Date	Version	Content
2016-07-06	1.0	Original release;
2016-11-10	1.1	Change input port fixed function to programmable function;
2017-01-10	1.2	Add output port function-lamp test function;
2019-02-28	1.3	Add CANBUS Communication.
2019-05-25	1.4	Fix front foil drawing.
2020-05-14	1.5	Change module setting contents
2021-03-21	1.7	Upgrade the translation; Modify the parameter range of "Bat Rated Volt" in Table 8; Change the manual font and the format of header and footer.



CONTENTS

1	OVERVIEW.....	5
2	PERFORMANCE AND CHARACTERISTICS.....	5
3	TECHNICAL PARAMETERS.....	6
4	CONTROLLER INFORMATION DISPLAY.....	7
5	OPERATION.....	8
5.1	PUSHBUTTON DESCRIPTION.....	8
5.2	CONTROLLER PANEL.....	9
5.3	START/STOP OPERATION OF REMOTE CONTROL.....	9
5.3.1	ILLUSTRATION.....	9
5.3.2	REMOTE START SEQUENCE.....	9
5.3.3	REMOTE STOP SEQUENCE.....	10
5.4	AUTO MODE START/STOP OPERATION.....	10
5.4.1	ILLUSTRATION.....	10
5.4.2	AUTO START SEQUENCE.....	10
5.4.3	AUTO STOP SEQUENCE.....	11
5.5	LOCAL START/STOP OPERATION.....	11
5.5.1	ILLUSTRATION.....	11
5.5.2	LOCAL START SEQUENCE.....	11
5.5.3	LOCAL STOP SEQUENCE.....	11
6	ALARMS.....	13
6.1	WARNING ALARM.....	13
6.2	SHUTDOWN ALARM.....	17
7	PARAMETER CONFIGURATION LIST.....	19
8	INPUT/OUTPUT PORT CONFIGURATION.....	25
8.1	AUXILIARY INPUT 1~10 FUNCTIONAL CONFIGURATION.....	25
8.1.1	DIGITAL INPUT PORT CONFIGURATION.....	25
8.1.2	INPUT PORT FUNCTIONS.....	25
8.2	OUTPUT PORT DEFINITION.....	26
8.2.1	DIGITAL OUTPUT DEFINITION CONTENTS.....	26
8.2.2	OUTPUT PORT 1-12 FUNCTIONS DEFINITION.....	26
8.3	SENSOR FUNCTIONAL CONFIGURATION.....	29
8.3.1	SENSOR CONFIGURATION.....	29
8.3.2	TEMPERATURE CURVES.....	31
8.3.3	PRESSURE CURVES.....	31
8.3.4	FUEL LEVEL CURVES.....	32
9	PARAMETER SETTING.....	33
9.1	MATTERS NEEDED ATTENTION.....	33
9.2	SENSOR SETTING CLARIFICATION.....	33
10	BACK PANEL.....	34
11	COMMUNICATION AND CONNECTION.....	37
11.1	RS485 AND LINK COMMUNICATION.....	37



11.2 CANBUS (EXPANSION) BUS COMMUNICATION	37
11.3 CONTROLLER AND ENGINES CONNECTION (EXPANSION CANBUS)	38
11.3.1 CUMMINS ISB/ISBE.....	38
11.3.2 CUMMINS QSL9.....	38
11.3.3 CUMMINS QSM11	39
11.3.4 DETROIT DIESEL DDEC III / IV	39
11.3.5 DEUTZ EMR2.....	39
11.3.6 JOHN DEERE.....	40
11.3.7 MTU MDEC.....	40
11.3.8 PERKINS.....	40
11.3.9 SCANIA.....	41
11.3.10 VOLVO EDC3.....	41
11.3.11 VOLVO EDC4.....	41
11.3.12 VOLVO-EMS2	42
11.3.13 BOSCH.....	42
11.3.14 POWER WIRING CONNECTION	42
12 HMC6000A 2 APPLICATION DIAGRAM	43
13 COMMISSIONING	44
14 INSTALLATION	44
14.1 FIXING CLIPS.....	44
14.2 OVERALL DIMENSIONS AND CUTOUT DIMENSIONS.....	45
15 INSTALLATION CAUTIONS	45
15.1 BATTERY VOLTAGE INPUT	45
15.2 SPEED SENSOR INPUT	45
15.3 OUTPUT AND EXPANSION RELAY.....	45
15.4 SENSOR INPUT.....	46
15.5 WITHSTAND VOLTAGE TEST.....	46
16 TROUBLESHOOTING.....	47

1 OVERVIEW

HMC6000A/HMC6000A 2 diesel engine controller integrates digitization, intelligentization and network technology which are used for genset automation and monitor control system of single unit to achieve automatic start/stop, data measure, alarm protection and “three remote” (remote control, remote measuring and remote communication). It fit with 132*64 liquid display, optional Chinese/English languages interface, and it is reliable and easy to use.

The powerful 32-bit ARM processor contained within the module allows for precision parameters measuring, fixed value adjustment, time setting and set value adjusting and etc..Majority parameters can be configured from front panel and can be configured by communication interface via PC. Due to its compact structure, simple connections and high reliability, **HMC6000A/HMC6000A 2** can be widely used in marine emergency engines, main propulsion engines, main generator engines and pumping engines.

HMC6000A/HMC6000A 2 diesel engine controller has an expansion CANBUS port that will be connected to a remote control module or expansion digital output module and security module.

2 PERFORMANCE AND CHARACTERISTICS

- 32-bit ARM micro-processor, 132*64 liquid display, optional Chinese/English interface, push-button operation;
- Connect with remote monitoring module via CANBUS (expand) port to realize remote monitoring and remote start/stop control;
- RPU560A security module can be expanded via CANBUS (expand) port;
- Dozens of engine, which is compatible with J1939 protocol, can be monitored via CANBUS(ECU) port;
- RS485 communication ports enable data communication as well as remote control, remote measurement and remote communication;
- Control and protection: remote/local start and stop diesel engine, alarm protection;
- Override mode, in which only overspeed and manual emergency shutdown can stop the engine;
- Parameter setting: parameters can be modified by users and stored into internal FLASH memory and cannot be lost even in case of power outage;
- Six sensor inputs for pressure, temperature, fuel level or other resistor type sensors; pressure sensor and Flexible sensor1~3 also can be set to (4~20)mA input and (0~5)V input;
- Real-time clock, engine total run-time accumulation, display the total start times;
- Built-in speed detection, which can accurately judge crank disconnect status, rated running and overspeed status.
- 99 event logs can be saved circularly and can be inquired on the spot;

- Digital regulation of all parameters - instead of analog regulation using conventional potentiometer - and, therefore, higher reliability and stability;
- Modular design, self-extinguishing ABS plastic enclosure and embedded installation way; small size and compact structure with easy mounting







3 TECHNICAL PARAMETERS

Table 2 Technical Parameters

Items	Content
Working Voltage	DC8.0V to DC35.0V, uninterrupted power supply
Power Consumption	<3W (Standby mode: ≤2W)
Speed Sensor Voltage	1.0V to 24V (RMS)
Speed Sensor Frequency	Max 10,000 Hz
Start Relay Output	16 A Connect to common output port
Stop Relay Output	16 A Connect to common output port
Fuel Relay Output	16 A Connect to common output port
Audio Alarm Output	7 A Connect to common output port
Common Alarm Output	7 A Connect to common output port
Flexible Relay Output 1-9	B+ DC supply, 0.5A output current
Flexible Relay Output 10-12	7 A AC250V voltage free output
Case Dimension	197 mm x 152 mm x 47 mm
Panel Cutout	186mm x 141mm
Working Conditions	Temperature: (-25~+70)°C; Humidity: (20~93)%RH
Storage Conditions	Temperature: (-25~+70)°C
Protection Level	IP65: when water proof gasket ring inserted between panel and housing.
Weight	0.70kg

4 CONTROLLER INFORMATION DISPLAY











Table 3 Controller Information Display

Screen	Display	Description
After pressing "Enter" for 1s, the controller will enter into parameter setting and information selection interface.	Return Parameter Setting Controller Information	After selected controller information, press "Enter" to enter into controller information interface.
First Screen	Controller Information Software Version 1.1 Release Date 2018-09-05 2018.10.15(5)09:30:10	This screen will display software version, hardware version and controller time. Press  or  to scroll screen.
Second Screen	O:S F S H A 1 2 3 4 5 6 7 8 9 10 11 12 Standby	This screen will display output port status, and engine status. Press  or  to scroll screen.
Third Screen	I: E 1 2 3 4 5 6 7 8 9 10 Standby	This screen will display input port status, and engine status. Press  or  to scroll screen.

5 OPERATION

5.1 PUSHBUTTON DESCRIPTION

Table 4 Key Function Description

Icon	Button	Description
	Stop	Stop running generator in local mode; During stopping process, press this button again to stop generator immediately.
	Start	Start standby genset in local mode.
	Mute	Alarm sound off.
	Self-Check	In standby mode, pressing this button, the controller can test alarms in the situation of no rotate speed.
	Alarm Reset	If alarm occurs, pressing this button will reset it.
	Lamp Test	Press this button will test panel LED indicators and display screen.
	Home	Shortcut to return to the main screen.
	Event Log	Shortcut to the alarm history page.
	Up	<ol style="list-style-type: none"> 1. Screen scroll. 2. Up cursor and increase value in setting menu.
	Down	<ol style="list-style-type: none"> 1. Screen scroll. 2. Down cursor and decrease value in setting menu.
	Enter	<ol style="list-style-type: none"> 1. Pressing and holding for more than 1 second to entry the parameter configuration and controller info selection menu. 2. In settings menu confirms the set value.

5.2 CONTROLLER PANEL

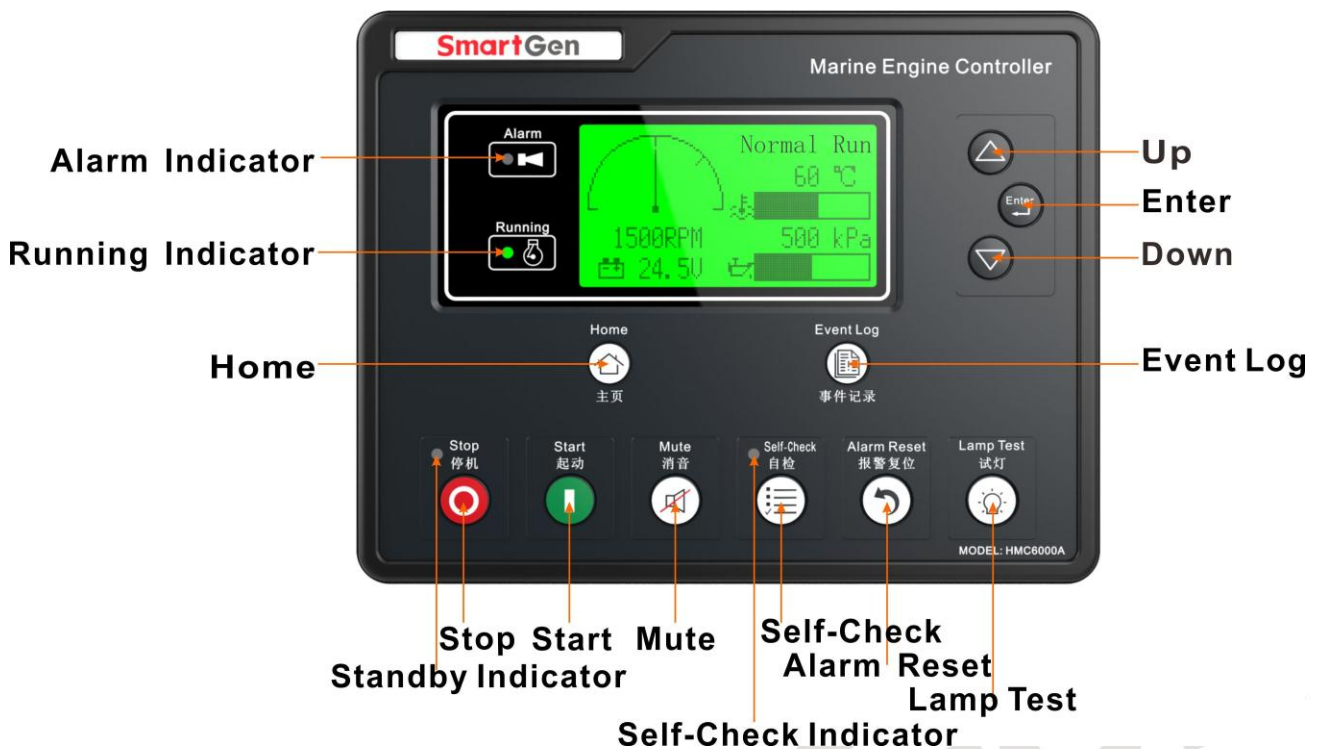

Fig.1 HMC6000A /HMC6000A 2 Front Panel

5.3 START/STOP OPERATION OF REMOTE CONTROL

5.3.1 ILLUSTRATION

Deploy any digital input port of HMC6000A/HMC6000A 2 to remote start input. After the “remote mode” is active, remote start/stop operation can be initiated.

5.3.2 REMOTE START SEQUENCE

- When “Remote Start” input is active, “Start Delay” timer is initiated;
- “Start Delay” countdown will be displayed on LCD;
- After “Start Delay” expired, preheat relay energizes (if configured), “Preheat Delay XX s” information will be displayed on LCD;
- After the above delay, the “Fuel Relay” is energized, and then one second later, the “Start Relay” is engaged. Genset is cranked for a pre-set time. If genset fails to fire during this cranking attempt then the fuel relay and start relay are disengaged for the pre-set rest period; “crank rest time” begins and wait for the next crank attempt;
- Should this start sequence continue beyond the set number of attempts, the start sequence will be terminated, the first line of LCD display will be highlighted with black and Fail to Start fault will be displayed;
- In case of successful crank attempt, the “Safety On” timer is activated. As soon as this delay is over, “start idle” delay is initiated (if configured);
- After the start idle, the generator enters into “Warming Up” status (if configured);
- When “Warming Up” delay is expired, engine will normally run.

▲ **Note:** If engine is started by remote monitoring module, there is no “Start Delay” step, and will jump to “Preheat Delay” directly.

5.3.3 REMOTE STOP SEQUENCE

- When “Stop Input” signal is active, “Stop Delay” timer is initiated;
 - After “Stop Delay” expired, cooling will be started;
 - After cooling, idle relay is energized while “Stop Idle” (if configured) starts;
 - Once this “Stop Idle” has expired, the “ETS Solenoid Hold” begins. ETS relay is energized while fuel relay is de-energized;
 - Once this “ETS Solenoid Hold” has expired, the “Wait Stop Time” begins. Complete stop is detected automatically;
 - Generator is placed into its standby mode after its complete stop. Otherwise, fail to stop alarm is initiated and the corresponding alarm information is displayed on LCD while entering into “Fail to Stop” status (If generator is stop successfully after “Fail To Stop” alarm has initiated, engine will enter into standby status).
- ▲ **Note:** If engine is stopped by remote monitoring module, there is no “Stop Delay” step, and will jump to cooling step directly.

5.4 AUTO MODE START/STOP OPERATION

5.4.1 ILLUSTRATION

Deploy any digital input port to auto-mode input. After the “Auto Mode” is active, Start/Stop operation can be initiated.

5.4.2 AUTO START SEQUENCE

- When “Auto Start” input is active or “Remote Start/ Stop” input is active, “Preheat Delay” is initiated;
- Preheat relay energizes (if configured), “Preheat Delay XX s” information will be displayed on LCD;
- After the above delay, the “Fuel Relay” is energized, and then one second later, the “Start Relay” is engaged. The genset is cranked for a pre-set time. If the genset fails to fire during this cranking attempt then the fuel relay and start relay are disengaged for the pre-set rest period; “crank rest time” begins and wait for the next crank attempt;
- Should this start sequence continue beyond the set number of attempts, the start sequence will be terminated, the first line of LCD display will be highlighted with black and Fail to Start fault will be displayed;
- In case of successful crank attempt, the “Safety On” timer is activated. As soon as this delay is over, “Start Idle” delay is initiated (if configured);
- When the “Start Idle” delay is over, “Warming Up” delay is initiated (if configured);
- When “Warming Up” delay is over, generator will enter into “Normal Running status”.

5.4.3 AUTO STOP SEQUENCE

- When “Stop Input” is active or “Start/Stop” input open, cooling is started;
- Once the “Cooling Delay” has expired, the “Stop Idle” delay is initiated (if configured). During “Stop Idle” Delay, idle relay is energized;
- Once the “Stop Idle” delay has expired, “ETS Solenoid Hold” begins. ETS relay is energized while fuel relay is de-energized;
- Once this “ETS Solenoid Hold” has expired, the “Wait Stop Time” begins. Complete stop is detected automatically;
- Generator is placed into its standby mode after its complete stop. Otherwise, fail to stop alarm is initiated and the corresponding alarm information is displayed on LCD while entering into “Fail to Stop” status (If generator is stop successfully after “Fail To Stop” alarm has initiated, engine will enter into standby status).

5.5 LOCAL START/STOP OPERATION

5.5.1 ILLUSTRATION

Deploy any digital input port to local-mode input. After the “local mode” is active, Start/Stop operation will be doable by pressing buttons on the controller.

Under local-mode, “Idle Output” is unavailable.

5.5.2 LOCAL START SEQUENCE

- Press  button to start the gen-set; preheat relay energizes (if configured), “preheat delay XX s” information will be displayed on LCD;
- After the above delay, the “Fuel Relay” is energized, and then one second later, the “Start Relay” is engaged. The genset is cranked for a pre-set time. If the genset fails to fire during this cranking attempt then the fuel relay and start relay are disengaged for the pre-set rest period and genset enters into “Energize to Stop” status;
- In case of successful crank attempt, the “Safety On” timer is activated;
- After the “Start Idle” delay expired, if the rotate speed, temperature and oil pressure of controller are regular, the generator will enter into “Normal Running” status directly.

5.5.3 LOCAL STOP SEQUENCE

- Press  button to enter into “Energize to Stop” status, ETS relay is energized while fuel relay is de-energized;
- Once the “ETS Solenoid Hold” delay has expired, “Wait Stop Time” begins. Complete stop is detected automatically;
- Generator is placed into its standby mode after its complete stop. Otherwise, fail to stop alarm is

initiated and the corresponding alarm information is displayed on LCD while entering into “Fail to Stop” status (If generator is stop successfully after “Fail To Stop” alarm has initiated, engine will enter into standby status).

Table 5 HMC6000A/HMC6000A 2 Start/Stop Description

System Mode	Local Start	Local Stop	Remote Start Input	Stop Input	Remote Start/Stop Input	Auto Start Input	Remote Module Start	Remote Module Stop
Local	•	•	-	-	-	-	-	-
Remote	-	-	•	•	-	-	•	•
Auto	-	-	-	•	•	•	-	-



6 ALARMS

6.1 WARNING ALARM

When controller detects warning alarms, which does not lead to shutdown, the detailed alarm information will be displayed on LCD.

Table 6 Warning Alarms

No.	Type	Detection Range	Description
1.	Over speed	Always active	When the controller detects that the engine speed has exceeded the pre-set value, it will initiate a warning alarm and the corresponding alarm information will be displayed on LCD.
2.	Under speed	From "Warming up" to "Cooling" delay	When the controller detects that the engine speed has fallen below the pre-set value, it will initiate a warning alarm and the corresponding alarm information will be displayed on LCD.
3.	Loss of Speed Signal	From "Start Idle" delay to "Stop Idle" delay	When the controller detects that the engine speed is 0 and action select "Warning", it will initiate a warning alarm and the corresponding alarm information will be displayed on LCD.
4.	Failed to start	Among set crank times, after "Start Completed"	Among set crank times, if genset failed to start, it will initiate a warning alarm and the corresponding alarm information will be displayed on LCD. Note: start attempt is forced as 1 time in local mode, and no alarms if failed to crank.
5.	Failed to stop	After "Fail to Stop" Delay	After "Fail to Stop" delay, if engine still has speed signal, it will initiate a warning alarm and the corresponding alarm information will be displayed on LCD.
6.	Charge Alt Fail	When generator is normal running	When the controller detects that charger voltage has fallen below the pre-set value, it will initiate a warning alarm and the corresponding alarm information will be displayed on LCD.
7.	Aux. Input 1-10	User defined	When the controller detects that the auxiliary input 1-10 warning signals, it will initiate a warning alarm and the corresponding alarm information will be displayed on LCD.
8.	High Water Temperature	Bigger than set speed	When the controller detects that the high water temperature warning signals, it will initiate a warning alarm and the corresponding alarm information will be displayed on LCD.



No.	Type	Detection Range	Description
9.	High Oil Temperature	Bigger than set speed	When the controller detects that the high oil temperature warning signals, it will initiate a warning alarm and the corresponding alarm information will be displayed on LCD.
10.	Low Oil Pressure	Bigger than set speed	When the controller detects that the low oil pressure warning signals, it will initiate a warning alarm and the corresponding alarm information will be displayed on LCD.
11.	Aux. Sensor 1-3 High	Bigger than set speed	When the controller detects that the Flexible sensor 1-3 warning signals, it will initiate a warning alarm and the corresponding alarm information will be displayed on LCD.
12.	Aux. Sensor 1-3 Low	Bigger than set speed	When the controller detects that the Flexible sensor 1-3 warning signals, it will initiate a warning alarm and the corresponding alarm information will be displayed on LCD.
13.	Water Temperature Open	Always active	When the controller detects that the water temperature sensor open warning signals, it will initiate a warning alarm and the corresponding alarm information will be displayed on LCD.
14.	Oil Temperature Open	Always active	When the controller detects that the oil temperature sensor open warning signals, it will initiate a warning alarm and the corresponding alarm information will be displayed on LCD.
15.	Oil Pressure Open	Always active	When the controller detects that the oil pressure sensor open warning signals, it will initiate a warning alarm and the corresponding alarm information will be displayed on LCD.
16.	Aux. Sensor 1-3 Open	Always active	When the controller detects that the flexible sensor 1-3 open warning signals, it will initiate a warning alarm and the corresponding alarm information will be displayed on LCD.
17.	Supply1 Under Volt	Always active	When the controller detects that the supply voltage has fallen below the pre-set value for more than 20s, it will initiate a warning alarm and the corresponding alarm information will be displayed on LCD.
18.	Supply 1 Over Volt	Always active	When the controller detects that the supply voltage has exceeded the pre-set value, it will initiate a warning



No.	Type	Detection Range	Description
			alarm and the corresponding alarm information will be displayed on LCD.
19.	Supply 2 Under Volt	Always active	When the controller detects that the supply voltage has fallen below the pre-set value for more than 20s, it will initiate a warning alarm and the corresponding alarm information will be displayed on LCD.
20.	Supply 2 Over Volt	Always active	When the controller detects that the supply voltage has exceeded the pre-set value, it will initiate a warning alarm and the corresponding alarm information will be displayed on LCD.
21.	DOUT 16 Comm. Fail	Always active (When DOUT16 is enabled)	When the controller detects DOUT 16 module communication failure, it will initiate a warning alarm and the corresponding alarm information will be displayed on LCD.
22.	HMC6000RM Comm. Fail	Always active (When HMC6000RM is enabled)	When the controller detects HMC6000RM module communication failure, it will initiate a warning alarm and the corresponding alarm information will be displayed on LCD.
23.	RPU560A Comm. Fail	Always active (When RPU560A is enabled)	When the controller detects RPU560A module communication failure, it will initiate a warning alarm and the corresponding alarm information will be displayed on LCD.
24.	HMP300 Comm. Fail	Always active (When HMP300 is enabled)	When the controller detects HMP300 module communication failure, it will initiate a warning alarm and the corresponding alarm information will be displayed on LCD.
25.	HMC9800RM Comm. Fail	Always active (When HMC9800 is enabled)	When the controller detects HMC9800RM module communication failure, it will initiate a warning alarm and the corresponding alarm information will be displayed on LCD.(HMC6000A 2 without this item)
26.	Fresh Water Pressure Low Input	Always active	When the input port defines this function, the controller will initiate a warning alarm and the corresponding alarm information will be displayed on LCD.
27.	Fresh Water Level Low Input	Always active	When the input port defines this function and it is active, the controller will initiate a warning alarm and the corresponding alarm information will be displayed on LCD.
28.	Grease Level Low	Always active	When the input port defines this function and it is



No.	Type	Detection Range	Description
	Input		active, the controller will initiate a warning alarm and the corresponding alarm information will be displayed on LCD.
29.	Fuel Leakage Input	Always active.	When the input is active, the controller will initiate a warning alarm and the corresponding alarm information will be displayed on LCD.
30.	ECU Warning	Always active	When there is ECU warning alarms, the corresponding alarm information and SPN and FMI will be displayed on LCD. Max.5 SPN codes of ECU alarm can be displayed.

▲ **Note:** The warning types of Auxiliary input are active only when they are configured by users.

▲ **Note:** The aux. input port 1~10 are corresponding with the input port A~J on the back plate of the controller.

▲ **Note:** The aux. sensor 1~3 are corresponding with the sensor A~C on the back plate of the controller.

DOUT16: 16-channel digital output expansion module.

RPU560A: security expansion module.

HMP300: power integrated protection expansion module.

HMC9800RM: remote monitoring expansion module.

6.2 SHUTDOWN ALARM

When controller detects shutdown alarms, controller will stop the genset and corresponding alarm information will display on the LCD.

Table 7 Shutdown Alarms

No.	Type	Detection Range	Description
1.	Emergency Stop	Always active	When the controller detects that the emergency stop is active, it will initiate a shutdown alarm and the corresponding alarm information will be displayed on LCD.
2.	Over speed	Always active	When the controller detects that the engine speed has exceeded the pre-set value, it will initiate a shutdown alarm and the corresponding alarm information will be displayed on LCD.
3.	Aux. Input 1-10	User defined	When the controller detects that the auxiliary input 1-10 shutdown signals, it will initiate a shutdown alarm and the corresponding alarm information will be displayed on LCD.
4.	High Water Temperature	Bigger than set speed	When the controller detects that the high water temperature shutdown is active, it will initiate a shutdown alarm and the corresponding alarm information will be displayed on LCD.
5.	High Oil Temperature	Bigger than set speed	When the controller detects that the high oil temperature shutdown is active, it will initiate a shutdown alarm and the corresponding alarm information will be displayed on LCD.
6.	Low Oil Pressure	Bigger than set speed	When the controller detects that the low oil pressure shutdown is active, it will initiate a shutdown alarm and the corresponding alarm information will be displayed on LCD.
7.	Aux. Sensor 1-3 High	Bigger than set speed	When the controller detects that the Flexible sensor 1-3 shutdown is active, it will initiate a shutdown alarm and the corresponding alarm information will be displayed on LCD.
8.	Aux. Sensor 1-3 Low	Bigger than set speed	When the controller detects that the Flexible sensor 1-3 shutdown is active, it will initiate a shutdown alarm and the corresponding alarm information will be displayed on LCD.
9.	ECU Shutdown	Always active.	When there is an ECU shutdown alarm, the corresponding alarm information and SPN and FMI will



No.	Type	Detection Range	Description
			be displayed on LCD. Max.5 SPN codes of ECU alarm can be displayed.
<p>▲ Note: The shutdown types of Auxiliary input are active only when they are configured by users.</p> <p>▲ Note: The aux. input port 1~10 are corresponding with the input port A~J on the back plate of the controller.</p> <p>▲ Note: The aux. sensor 1~3 are corresponding with the sensor A~C on the back plate of the controller.</p>			

SmartGen

7 PARAMETER CONFIGURATION LIST

Hold and press  for 1s to enter into parameter configuration and controller info selection menu after input the correct password (Default password as 00318). Please contact the manufacturer if forget password or need sensor resistance/current calibration.

Table 8 Parameter Configuration Items

Parameter	Range	Default	Remarks
1. Start delay	(1-3600) s	1	The time from remote start signal active to complete start when the controller is in remote mode.
2. Stop delay	(1-3600) s	1	The time from remote stop signal active to complete stop when the controller is in remote mode.
3. Pre-heating delay	(0-3600) s	0	The time of heater plug energized before starter energized.
4. Cranking Time	(3-60) s	8	The every starter energized time.
5. Crank Rest Time	(3-60) s	10	The waiting time before second energizes start when starter failed to start.
6. Safety on Time	(0-3600) s	10	First running time after machine started.
7. Start Idle time	(0-3600) s	0	Idle running time when genset start.
8. Warming Up Time	(0-3600) s	10	Warming up time after genset enters into hi-speed running.
9. Cooling Time	(0-3600)s	10	Cooling time before stop.
10. Stop Idle Time	(0-3600) s	0	Stop idle time when stop.
11. ETS Hold Time	(0-3600) s	20	Stop magnet energized time when the genset is to stop.
12. Wait Stop Time	(0-3600) s	0	Time from idle delay finished to wait stop when "ETS Hold Time" is set to 0; time from ETS hold to wait stop when "ETS Hold Time" isn't set to 0.
13. Start Key Confirm	(0.2-5.0) s	0.2	The time from pressing start button to start performance when the controller starts by button-press.
14. Stop Key Confirm	(0.2-5.0) s	0.2	The time from pressing stop button to stop performance when the controller stops by button-press.
15. J1939 Enable	(0-1) 0: Disabled 1: Enabled	0: Disabled	After enabled, J1939 monitoring can be achieved via select related engine type.
16. Engine Type	(0-39)	0: Conventional Engine	Default: Conventional Genset. When connect to J1939 genset, please select related engine type.
17. SPN Version	(1-3)	1	Alarm analysis type of SPN
18. ECU Shutdown Enable	(0-1)	0: Disabled	After enabled, genset shuts down when detected red lamp alarms.



Parameter	Range	Default	Remarks
19. Flywheel teeth	(1-300)	118	The flywheel teeth installed in genset is used for judgment of separate conditions and detection of rotate speed. See 14 Installations.
20. Rated speed	(1-5999)r/min	1500	Provide standard for judgment of over speed and under speed.
21. Start Attempts	(1-30)	3	The maximum of start attempts when genset failed to start. When it arrive pre-set value, the controller will send failed to start signal.
22. Crank Disconnect Condition	(0-2) 0: Speed 1: Oil Press. 2: Speed+ OP	0: Speed	The three disconnection conditions of starter and engine, which can be used alone or simultaneously, are used to make starter motor disconnect with engine as soon as possible.
23. Disconnect OP	(10-1000)kPa	80	Disconnect when Oil Pressure exceeds preset value.
24. Disconnect Speed	(0-200)%	25%	Set value is percentage of rated rotate speed. When speed exceeds pre-set value, starter will separate.
25. Under Speed Shutdown	(0-1) 0 Disabled 1 Enabled	0 Disabled	Under speed shutdown setting.
26. Set Value	(0-200)%	85%	
27. Delay	(0-3600) s	3	
28. Under Speed Warn	(0-1) 0 Disabled 1 Enabled	0 Disabled	Under speed warning setting.
29. Set Value	(0-200)%	90%	
30. Return Value	(0-200)%	92%	
31. Delay	(0-3600) s	3	
32. Over Speed Shutdown	(0-1) 0 Disabled 1 Enabled	1 Enabled	Over speed shutdown setting.
33. Set Value	(0-200)%	115%	
34. Delay	(0-3600) s	1	
35. Over Speed Warn	(0-1) 0 Disabled 1 Enabled	1 Enabled	Over speed warning setting.
36. Set Value	(0-200)%	110%	
37. Return Value	(0-200)%	108%	
38. Delay	(0-3600) s	3	
39. Speed Signal Lose Delay	(0-3600) s	3	The time from that detecting speed is 0 to confirm action.
40. Speed Signal Lose Action	(0-2) 0: Warn	1: Shutdown	The action after detecting loss of speed.

Parameter	Range	Default	Remarks
	1: Shutdown 2: No Action		
41. Charge Alt Fail	(0-60.0)V	16.0	After engine is normal running, controller will initiate an alarm when voltage of charger falls below this limit.
42. Bat Rated Volt	(0-60.0)V	24.0	Provide standard for judgment of over voltage and under voltage.
43. Power 1 Over Volt	(0-200)%	125%	Set value is percentage of power supply rated voltage.
44. Power 1 Under Volt	(0-200)%	75%	
45. Power 2 Over Volt	(0-200)%	125%	Set value is percentage of power supply rated voltage.
46. Power 2 Under Volt	(0-200)%	75%	The main interface won't display voltage of power supply A and B when this value is set as 0. Main interface icon will show battery 1 voltage.
47. Heating Up Limit	(0-100)°C	42	Open when temperature of water temperature sensor larger than pre-set value.
48. Heat Down Limit	(0-100)°C	37	Close when temperature of water temperature sensor less than pre-set value.
49. Pre-lubrication Cycle Enable	(0-1) 0 Disabled 1 Enabled	0 Disabled	It can circulate pre-lubrication for genset after setting enabled.
50. Pre-lubrication Interval	(0-7200)min	300	It can set circulate period after circulate pre-lubrication.
51. Pre-lubrication Time	(0-7200)s	300	The time of each pre-lubrication.
52. Idle Set	(0-2000)r/min	700	When the controller is speed regulating automatically, the controller needs a stable rotate speed value.
53. Dead Band	(0-10.0)%	1.0	Relay automatic speed regulation setting. Note: as rated idle percent (in no working area idle); as rated speed percent (in high speed).
54. Gain	(0-100)%	10	
55. Response	0.25-4.00	0.50	
56. Stability	(0.05-1.60)s	1.0	
57. Speed Wire Break	(0-1) 0 Disabled 1 Enabled	0 Disabled	It can detect engine speed sensor wire break if enabled.
58. Device ID	(1-254)	1	RS485 Comm. Address.
59. Language Select	(0-1) 0: Chinese 1: English	0: Chinese	Language selections.
60. Password Set	(0-65535)	00318	Password of parameter setting.
61. DOUT16 Enable	(0-1)	0 Disabled	If DOUT16 module is needed to expand, this setting enabled is needed.
62. HMC6000RM Module Enable	(0-1)	0 Disabled	If HMC6000RM module is needed to expand, this setting enabled is needed.
63. RPU560A Enable	(0-1)	0: Disabled	If RPU560A module is needed to expand,



Parameter	Range	Default	Remarks
			this setting enabled is needed.
64. Expand Baud Set	(0-1) 0: 250kbps 1: 125kbps	0: 250kbps	CANBUS port communication Baud rate.
65. HMP300 Module Enable	(0-1) 0:Disabled 1:Enable	0: Disabled	If HMP300 module is needed to expand, this setting enabled is needed.
66. HMC9800RM Module Enable	(0-1) 0:Disabled 1:Enable	0: Disabled	If HMC9800RM module is needed to expand, this setting enabled is needed. (HMC6000A 2 does not have this function)
67. Self-check Type	(0-1) 0:Self-Check Mode 1 1: Self-check Mode 2	0: Self-check Mode 1	When self-check is set as 1, it can test alarm by connecting with corresponding sensor with no rotated speed after self-check is active; when self-check is set as 2, it can test alarm with system auto-regulating the sensor after self-check is active.
68. Date & Time			Date &Time setting.
69. Water Temp. Sensor set (Resistance input)	See 8.3. <i>Sensor functional configuration</i> Note: Resistance input measuring range is not applicable.		Water temperature sensor setting.
70. Oil Temp. Sensor set (Resistance input)	See 8.3. <i>Sensor functional configuration</i> Note: R Resistance input measuring range is not applicable.		Oil temperature sensor setting.
71. Oil Pressure Sensor set (Resistance/voltage/current input)	See 8.3. <i>Sensor functional configuration</i> Note: Resistance input measuring range is not applicable.		Oil pressure sensor setting.
72. Flexible sensor 1 Set (Resistance/voltage/current input)	See 8.3. <i>Sensor functional configuration</i> Note: Resistance input measuring range is not applicable.		Flexible sensor1 setting.
73. Flexible sensor 2 Set (Resistance/voltage/current input)	See 8.3. <i>Sensor functional configuration</i> Note: Resistance input measuring range is not applicable.		Flexible sensor2 setting.
74. Flexible sensor 3 Set (Resistance/voltage/current input)	See 8.3. <i>Sensor functional configuration</i> Note: Resistance input measuring range is not		Flexible sensor3 setting.

Parameter	Range	Default	Remarks
	applicable.		
75. Input 1 Set	(0-50)	18: Local Mode IN	See table 8.1.2.
76. Active type	(0-1)	0: Close Activate	Set up input port active of close or open.
77. Input 2 Set	(0-50)	19: Remote Mode IN	See table 8.1.2.
78. Active type	(0-1)	0: Close Activate	Set up input port active of close or open.
79. Input 3 Set	(0-50)	0: Not Used	See table 8.1.2.
80. Active type	(0-1)	0: Close Activate	Set up input port active of close or open.
81. Input 4 Set	(0-50)	0: Not Used	See table 8.1.2.
82. Active type	(0-1)	0: Close Activate	Set up input port active of close or open.
83. Input 5 Set	(0-50)	0: Not Used	See table 8.1.2.
84. Active type	(0-1)	0: Close Activate	Set up input port active of close or open.
85. Input 6 Set	(0-50)	0: Not Used	See table 8.1.2.
86. Active type	(0-1)	0: Close Activate	Set up input port active of close or open.
87. Input 7 Set	(0-50)	20: Remote Start Input	See table 8.1.2.
88. Active type	(0-1)	0: Close Activate	Set up input port active of close or open.
89. Input 8 Set	(0-50)	21: Stop Input	See table 8.1.2.
90. Active type	(0-1)	0: Close Activate	Set up input port active of close or open.
91. Input 9 Set	(0-50)	23: Override Mode	See table 8.1.2.
92. Active type	(0-1)	0: Close Activate	Set up input port active of close or open.
93. Input 10 Set	(0-50)	11: Fuel Leakage Input	See table 8.1.2.
94. Active type	(0-1)	0: Close Activate	Set up input port active of close or open.
95. Output 1 Set	(0-100)	0: Not Used	See table 8.2.2.
96. Output type	(0-1)	0: Open	Set up output port be always open or always close.
97. Output 2 set	(0-100)	0: Not Used	See table 8.2.2.
98. Output type	(0-1)	0: Open	Set up output port be always open or always close output.
99. Output 3 set	(0-100)	0: Not Used	See table 8.2.2.
100. Output type	(0-1)	0: Open	Set up output port be always open or always close output.
101. Output 4 set	(0-100)	0: Not Used	See table 8.2.2.

Parameter	Range	Default	Remarks
102. Output type	(0-1)	0: Open	Set up output port be always open or always close output.
103. Output 5 set	(0-100)	0: Not Used	See table 8.2.2.
104. Output type	(0-1)	0: Open	Set up output port be always open or always close output.
105. Output 6 set	(0-100)	0: Not Used	See table 8.2.2.
106. Output type	(0-1)	0: Open	Set up output port be always open or always close output.
107. Output 7 set	(0-100)	0: Not Used	See table 8.2.2.
108. Output type	(0-1)	0: Open	Set up output port be always open or always close output.
109. Output 8 set	(0-100)	0: Not Used	See table 8.2.2.
110. Output type	(0-1)	0: Open	Set up output port be always open or always close output.
111. Output 9 set	(0-100)	0: Not Used	See table 8.2.2.
112. Output type	(0-1)	0: Open	Set up output port be always open or always close output.
113. Output 10 set	(0-100)	0: Not Used	See table 8.2.2.
114. Output type	(0-1)	0: Open	Set up output port be always open or always close output.
115. Output 11 set	(0-100)	0: Not Used	See table 8.2.2.
116. Output type	(0-1)	0: Open	Set up output port be always open or always close output.
117. Output 12 set	(0-100)	0: Not Used	See table 8.2.2.
118. Output type	(0-1)	0: Open	Set up output port be always open or always close output.
<p>▲ Note: The aux. input port 1~10 are corresponding with the input port A~J on the back plate of the controller.</p> <p>▲ Note: The aux. output port 1~12 are corresponding with the output port A~L on the back plate of the controller.</p> <p>▲ Note: The Flexible sensor 1~3 are corresponding with the sensor A~C on the back plate of the controller.</p>			

8 INPUT/OUTPUT PORT CONFIGURATION

8.1 AUXILIARY INPUT 1~10 FUNCTIONAL CONFIGURATION



8.1.1 DIGITAL INPUT PORT CONFIGURATION

Table 9 Digital Input Port Definition

No.	Settings	Contents	Description
1	Feature Set	(0- 50)	See 8.1.2 Input Port Functions
2	Active type	(0-1)	0: Close Activate 1: Open Activate
3	Active Range	(0-3)	0: From Safety on 1: From Crank 2: Always 3: Never
4	Action	(0-2)	0: Warning 1: Shutdown 2: Indication
5	Input Delay	(0-20.0)s	
6	Displayed string	User-defined input port names	20 English symbols or 10 Chinese characters

8.1.2 INPUT PORT FUNCTIONS

Table 10 Input Ports Function Definition

No.	Function	Description
0.	Not Used	Not used.
1.	Custom	Users configured input port settings.
2.	Alarm Mute	Can prohibit "Audible Alarm" output when it is active.
3.	Reset Alarm	Can reset all alarms when input is active.
4.	Pre-lubricate	If output is set as pre-lubrication output, the relay disconnects after the set pre-lubrication delay.
5.	Reserved	
6.	Panel Lock	All buttons in panel is inactive except  and  when input is active.
7.	Quick Start	Cranking will start directly (without preheating) when the input is active.
8.	Remote Start/Stop	Genset starts when active and stops when inactive. Note: only one of two start/stop control ways (remote start/stop input, and remote starts input and remote stop input) can be selected, and cannot select at the same time.
9.	Auto Mode IN	When the input is active, enter into auto mode, the local mode and remote mode is inactive and start/stop can only be achieved via input port.
10.	Turning Chain	Start inhibition when the input is active.
11.	Fuel Leakage Input	When the input active, alarm initiate if fuel leak occurs.
12.	Water Press. Low	Connect to digital input of sensor.
13.	Water Level Low	Connect to digital input of sensor.
14.	Oil Level Low	Connect to digital input of sensor.
15.	Water Temp. High IN	Connect to digital input of sensor.
16.	Oil Temp. High IN	Connect to digital input of sensor.
17.	Oil Pressure Low IN	Connect to digital input of sensor.
18.	Local Mode IN	The genset is in local mode when active.
19.	Remote Mode IN	The genset is in remote mode when active.
20.	Remote Start Input	When remote start input is active in Remote Control Mode, controller initiate start command.
21.	Stop Input	When stop input is active in Remote Control Mode or



No.	Function	Description
		Auto Mode, controller initiate stop command.
22.	Auto Start Input	When auto start input is active in Auto Mode, controller initiate start command.
23.	Override Mode	When over ride mode input is active, only over speed stop and emergency stop are available.
24~50	Reserved	

▲ **Note:** The name of the input ports 1~10 only can be configured via PC software.

8.2 OUTPUT PORT DEFINITION

8.2.1 DIGITAL OUTPUT DEFINITION CONTENTS

Table 11 Digital Output Port Definition Content

No.	Items	Contents	Note
1	Output Function Configuration	(0-100)	
2	Effective ways	0 Open 1 Close	
3	Effective duration	Bit1: Standby Bit2: Preheat Bit3: Fuel Output Bit4: Start Bit5: Crank Rest Time Bit6: Safety Delay Bit7: Start Idle Bit8: High Speed Warm Up Bit9: Wait to Load Bit10: Normally Working Bit11: Cooling Bit12: Stop Idle Bit13: ETS Bit14: Wait for Stop Bit15: Fail to Stop	
5	Delay output time	(0-100.0)s	
6	Output time	(0-3600)s	

8.2.2 OUTPUT PORT 1-12 FUNCTION DEFINITION

Table 12 Output Port 1-12 Function Definition

No.	Items	Description
0.	Not Used	This port is not used.
1.	Custom	See Table 11.
2.	Air Flap	Action when over speed shutdown and emergence stop. Air flap can be closed.
3.	Audible Alarm	Action when warning and shutdown. It can be connected enunciator externally. When "alarm mute" configurable input port is active, it can remove the alarm.
4.	Crank Output	Action when genset is starting and disconnect when crank success.



No.	Items	Description
5.	Fuel Output	Action when genset is starting and disconnect when stop is completed.
6.	ETS Hold	Action period: ETS hold delay.
7.	Reserved	
8.	Reserved	
9.	Loss of Speed	After safety on delay, the controller active when the engine speed is 0.
10.	Pre-lubricate	The controller output when the engine is in standby mode (user-defined output delay) if pre-lubrication input is active.
11.	Override Output	The controller output when it is in Over ride mode.
12.	Ready Go(1)	The controller output when it is in standby mode and no alarms.
13.	Heater Control	It is controlled by heating temperature sensor's limited threshold.
14.	Idle Control	Action from "crank delay" to "start idle delay" and from "stop idle delay" to "wait for stop delay". When in local mode, idle control is unavailable.
15.	Common Alarm	Action when genset common warning and common shutdown alarms occur.
16.	Common Shutdown	Action when common shutdown alarm.
17.	Common Warn	Action when common warning alarm.
18.	Input 1 Active	Action when digital input port 1 is active.
19.	Input 2 Active	Action when digital input port 2 is active.
20.	Input 3 Active	Action when digital input port 3 is active.
21.	Input 4 Active	Action when digital input port 4 is active.
22.	Input 5 Active	Action when digital input port 5 is active.
23.	Input 6 Active	Action when digital input port 6 is active.
24.	Start Successful Output	The engine outputs when the speed over 500r, stops when the speed less than 100r.
25.	Normal Running Output	The engine outputs when the speed over 85% of rated requirements, stops when less than 75% of rated requirements.
26.	Remote Mode Output	The controller output in remote control mode.
27.	Local Mode Output	The controller output in local mode.
28.	Ready Go(2)	Output when there is no shutdown alarm.
29.	DOUT16 Com Fail	Action when the controller detects communication failure with DOUT16. (3s overtime)
30.	Shutdown Output	The controller output when it is shutdown mode.
31.	Power 1 Under Volt	Action when the controller detects that the power 1 voltage has fallen below the set value.
32.	Power 1 Over Volt	Action when the controller detects that the power 1 voltage has exceeded the set value.
33.	Under Speed Warn	Action when under speed warning.
34.	Under Speed Stop	Action when under speed shutdown alarm.



No.	Items	Description
35.	Over Speed Warn	Action when over speed warning.
36.	Over Speed Stop	Action when over speed shutdown alarm.
37.	Emergency Stop	Action when emergency stop alarm.
38.	Charge Alt Fail	Action when charge failure warning.
39.	Failed To Start	Action when failed start alarm.
40.	Failed To Stop	Action when failed stop alarm.
41.	Reserved	
42.	Water Temp. Open	Action when water temperature sensor is open circuit.
43.	Water Temp. High Warn	Action when high water temperature sensor warning alarm.
44.	Water Temp. High Stop	Action when high water temperature sensor shutdown alarm.
45.	Oil Temp. Open	Action when oil temperature sensor is open circuit.
46.	Oil Temp. High Warn	Action when high oil temperature sensor warning alarm.
47.	Oil Temp. High Stop	Action when high oil temperature sensor shutdown alarm.
48.	Oil Pressure Open	Action when oil pressure sensor is open circuit.
49.	Oil Pressure Low Warn	Action when low oil pressure sensor warning alarm.
50.	Oil Pressure Low Stop	Action when low oil pressure sensor shutdown alarm.
51.	Sensor 1 Open	Action when Flexible sensor 1 is open circuit.
52.	Sensor 1 Warn	Action when Flexible sensor 1 warning alarm.
53.	Sensor 1 Shutdown	Action when Flexible sensor 1 shutdown alarm.
54.	Sensor 2 Open	Action when Flexible sensor 2 is open circuit.
55.	Sensor 2 Warn	Action when Flexible sensor 2 warning alarm.
56.	Sensor 2 Shutdown	Action when Flexible sensor 2 shutdown alarm.
57.	Reserved	Reserved
58.	RPU560A Com Fault	Action when the controller detects communication failure with RPU560A safeguard module. (3s overtime)
59.	RPU560A Power 1 Fault	Security module output when power1 fault.
60.	RPU560A Power 2 Fault	Security module output when power2 fault.
61.	Rise Speed	When the controller is in idle mode, if speed doesn't arrive at rated idle, it will output when speed is rising and auto disconnect when speed arrives at rated idle. When the controller is hi-speed running, if speed doesn't arrive at rated rotate speed, it will output when speed is rising and auto disconnect when speed arrives at rated rotate speed. Note: Active only when controller is in remote/auto mode.
62.	Drop Speed	When the controller is in idle mode, if speed exceeds rated idle, it will output when speed is dropping and auto disconnect when speed arrives at rated idle. When the controller is hi-speed running, if speed exceeds rated rotate speed, it will output while speed is dropping and auto disconnect when speed arrives at rated rotate speed. Note: Active only when controller is in remote/auto mode.
63.	Sensor 3 Open	Action when Flexible sensor 3 is open circuit.
64.	Sensor 3 Warn	Action when Flexible sensor 3 warning alarm.
65.	Sensor 3 Shutdown	Action when Flexible sensor 3 shutdown alarm.



No.	Items	Description
66.	Fuel Leakage	Output when this alarm is active.
67.	Power 2 Under Volt	Output when the controller detects power 2 voltage is lower than set value.
68.	Power 2 Over Volt	Output when the controller detects power 2 voltage is upper than set value.
69.	Lamp Test Output	Output while lamp testing.
70~100	Reserved	Reserved

8.3 SENSOR FUNCTIONAL CONFIGURATION

8.3.1 SENSOR CONFIGURATION

Table 13 Controller Sensor Configuration

No.	Settings	Contents	Remarks
1.	Sensor type	(0-3) 0: Not Used 1: Oil Pressure Sensor 2: Temperature Sensor 3: Fuel Level Sensor	Types such as "Water Temperature Sensor", "Oil Temperature Sensor", and "Oil Pressure Sensor" are not optional and are fixed temperature or pressure.
2.	Curve Type	Curve types list	See 8.3.2/8.3.3/8.3.4 curve lists.
3.	Alarm speed	(0-200)%	Alarm and test when the engine speed has exceeded the set value.
4.	Range	(0-6000)	Active when current of sensor is between (4~20)mA. Corresponding unit of pressure sensor is kPa; Corresponding unit of level sensor is %.
5.	Display Units	Temperature 0: °C 1: °F Pressure 0: kPa 1: bar 2: psi Fuel level unit fixed as "%"	The units displayed on LCD. After selection of units, the displayed data will automatically convert according to units.
6.	High Shutdown Enable	(0-1) 0: Enable 1: Disable	
7.	Set Value	(0-6000)	
8.	Delay	(0-3600)s	
9.	Low Shutdown Enable	(0-1) 0: Enable 1: Disable	
10.	Set Value	(0-4000)	
11.	Delay	(0-3600)s	
12.	Sensor High Warn Enable	(0-1)	



No.	Settings	Contents	Remarks
		0: Enable 1: Disable	
13.	Set Value	(0-6000)	
14.	Return Value	(0-6000)	
15.	Delay	(0-3600)s	
16.	Low Warn Enable	(0-1) 0: Enable 1: Disable	
17.	Set Value	(0-4000)	
18.	Return Value	(0-4000)	
19.	Delay	(0-3600)s	
20.	First point X (Resistance)	Resistance type (not PT100)	Sensor curve is user-defined X axis: 8 Y axis: 8.
21.	Second point X (Resistance)	Resistance type (not PT100)	
22.	Third point X (Resistance)	Resistance type (not PT100)	
23.	Fourth point X (Resistance)	Resistance type (not PT100)	
24.	Fifth point X (Resistance)	Resistance type (not PT100)	
25.	Sixth point X (Resistance)	Resistance type (not PT100)	
26.	Seventh point X (Resistance)	Resistance type (not PT100)	
27.	Eighth point X (Resistance)	Resistance type (not PT100)	
28.	First point Y (Value)	Resistance type (not PT100)	
29.	Second point Y (Value)	Resistance type (not PT100)	
30.	Third point Y (Value)	Resistance type (not PT100)	
31.	Fourth point Y (Value)	Resistance type (not PT100)	
32.	Fifth point Y (Value)	Resistance type (not PT100)	
33.	Sixth point Y (Value)	Resistance type (not PT100)	
34.	Seventh point Y (Value)	Resistance type (not PT100)	
35.	Eighth point Y (Value)	Resistance type (not PT100)	
36.	User-defined string	User-defined sensor names	Only can be set via upper computer software.

8.3.2 TEMPERATURE CURVES

Table 14 Temperature Curve List

No.	Contents	Remarks
0	Not Used	The input range of user-defined resistance is between (0-1000) Ω . The factory defaults of water temperature sensor and oil temperature sensor are PT100 sensors.
1	PT100	
2	Custom Res Curve	
3	VDO	
4	CURTIS	
5	VOLVO-EC	
6	DATCON	
7	SGX	
8	SGD	
9	SGH	
10	Reserved	
11	Cu50	
12	Reserved	
13	Reserved	
14	Reserved	
15	Reserved	

▲ Note: PT100 Resistance type temperature sensor division value is fixed set as 0.385 (0.385 Ω corresponds to 1 $^{\circ}$ C).

8.3.3 PRESSURE CURVES

Table 15 Pressure Curve List

No.	Contents	Remarks
0	Not Used	The input range of User-defined resistance is between (0-1000) Ω . The factory default of oil pressure sensor is (4-20)mA sensor.
1	(4~20)mA	
2	Custom Res Curve	
3	VDO 10Bar	
4	CURTIS	
5	Volt (0.5V-4.5V)	
6	DATCON 10Bar	
7	SGX	
8	SGD	
9	SGH	
10	Custom Volt Curve	
11	Reserved	
12	Reserved	
13	Reserved	
14	Reserved	
15	Reserved	

▲ Note: There is no need to set curve type but range if the pressure sensor is current type.

8.3.4 FUEL LEVEL CURVES

Table 16 Fuel Level Curve List

No.	Contents	Remarks
0	Not Used	The default of sensor type doesn't have fuel level sensor. Please chose one of Flexible sensor 1/2/3 to use if need to.
1	(4~20)mA	
2	Custom Res Curve	
3	SGD	
4	SGH	
5	Reserved	
6	Reserved	
7	Reserved	
8	Reserved	
9	Reserved	
10	Reserved	
11	Reserved	
12	Reserved	
13	Reserved	
14	Reserved	
15	Reserved	

▲ **Note:** There is no need to set curve type but range if the pressure sensor is current type.

9 PARAMETER SETTING

9.1 MATTERS NEEDED ATTENTION

Press the button  for 1 second after start the controller, and then enter into parameter configuration and controller info selection menu, in which enter parameter configuration menu needs to input correct password. The default password is 00318.

Please contact with manufacturer when forgets the password or need to correct the resistance/current/voltage value.

- Please modify the controller internal parameters in standby mode (such as starting successfully condition selections, auxiliary inputs, output port configuration, time delay, etc), otherwise the alarm stop or other abnormal phenomena may occur.
- High sensor alarm threshold value must be bigger than the low alarm threshold, otherwise they will both alarm simultaneously.
- Over speed threshold value must be bigger than under speed threshold, otherwise there will be either overspeed or underspeed simultaneously.
- When setting the condition of successful start, the start speed threshold value is supposed to be set lower as possible for quick disconnection of starter.
- Auxiliary input port 1-10 cannot be set to the same project, otherwise correct function cannot arrive. Auxiliary output port 1-12 can be set to the same project.

9.2 SENSOR SETTING CLARIFICATION

- When reselect the sensors, the standard value of the selected sensor will be selected. If temperature sensor default is set to PT100, sensor curve will be the curve of PT100. If it is set to SGD (120°C resistance), sensor curve will be the curve of SGD.
- If standard sensor curve is mismatching with sensor in using, "User-defined sensor" could be chosen, then input user-defined sensor curve.
- When inputting sensor curve, X (resistance) must be input in accordance with the order of growing up, otherwise mistakes will occur.
- Can set ordinate of front several points or last several points to the same. As shown in below:

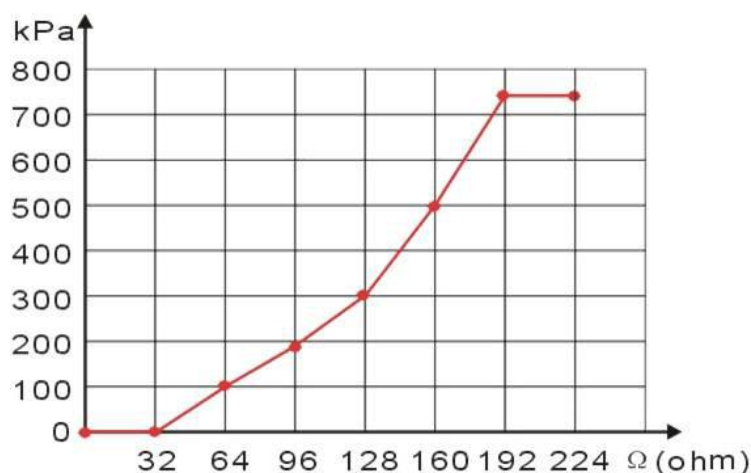

Fig.2 Sensor Setting Curve

Table 17 Normal Pressure Unit Conversion Table

	N/m ² Pa	kgf/cm ²	bar	psi
1Pa	1	1.02x10 ⁻⁵	1x10 ⁻⁵	1.45x10 ⁻⁴
1kgf/cm ²	9.8x10 ⁴	1	0.98	14.2
1bar	1x10 ⁵	1.02	1	14.5
1psi	6.89x10 ³	7.03x10 ⁻²	6.89x10 ⁻²	1

10 BACK PANEL

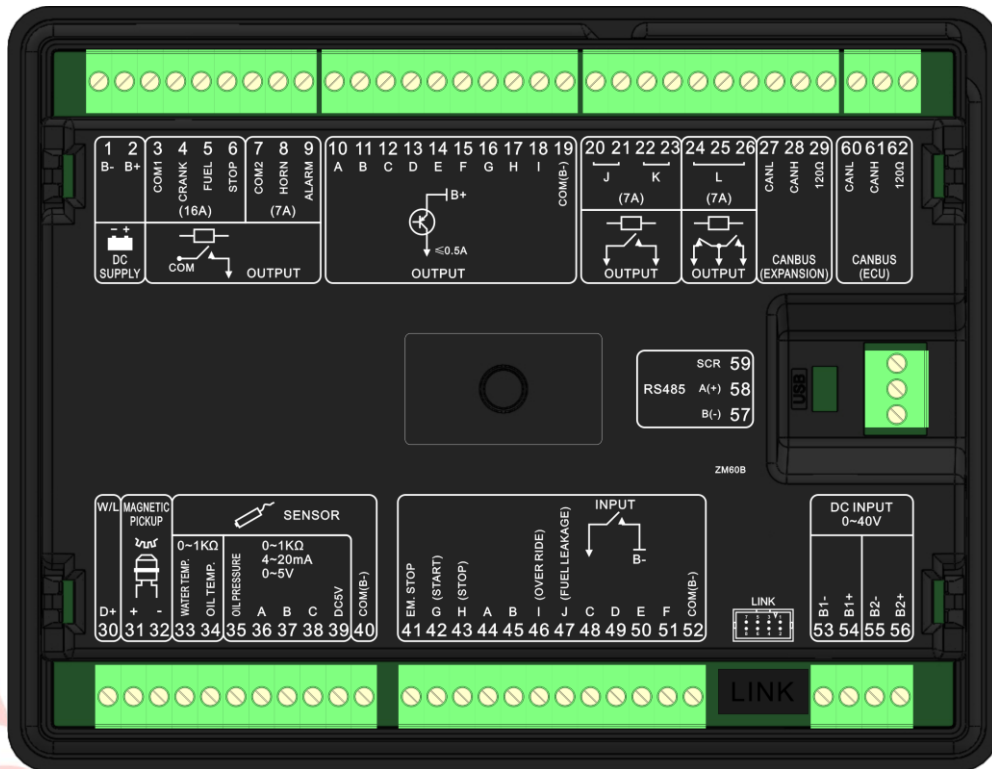
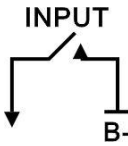

Fig.3 HMC6000A 2 Controller Back Panel

Table 18 Terminal Connection Description

Icon	No.	Function	Cable Size	Description
	1.	DC input B-	2.5mm ²	DC power supply negative input.
	2.	DC input B+	2.5mm ²	DC power supply positive input.
	3.	COM1 Relay common port	1.5mm ²	Connect to COM1 relay output; rated 16A
	4.	Start relay	1.5mm ²	
	5.	Fuel relay	1.5mm ²	
	6.	Stop relay	1.5mm ²	Connect to COM2 relay output; rated 16A
	7.	COM2 Relay common port	1.0mm ²	
	8.	Audio Alarm Relay	1.0mm ²	
	9.	Common Alarm Relay	1.0mm ²	
	10.	Aux. output 1(A)	1.0mm ²	B+ output, rated 0.5A.

Icon	No.	Function	Cable Size	Description
	11.	Aux. output 2(B)	1.0mm ²	B+ output, rated 0.5A.
	12.	Aux. output 3(C)	1.0mm ²	B+ output, rated 0.5A.
	13.	Aux. output 4(D)	1.0mm ²	B+ output, rated 0.5A.
	14.	Aux. output 5(E)	1.0mm ²	B+ output, rated 0.5A.
	15.	Aux. output 6(F)	1.0mm ²	B+ output, rated 0.5A.
	16.	Aux. output 7(G)	1.0mm ²	B+ output, rated 0.5A.
	17.	Aux. output 8(H)	1.0mm ²	B+ output, rated 0.5A.
	18.	Aux. output 9(I)	1.0mm ²	B+ output, rated 0.5A.
	19.	COM(B-)	1.0mm ²	
	20.	Aux. output 10(J)	1.0mm ²	Free volts contact always open; Rated current: 7A; volt free output.
	21.		1.0mm ²	
	22.	Aux. output 11(K)	1.0mm ²	
	23.		1.0mm ²	
	24.	Aux. output 12(L)	1.0mm ²	Free volts contact always open; Rated current: 7A; volt free output.
	25.		1.0mm ²	
	26.		1.0mm ²	
CANBUS (EXPANSION)	27.	CAN(L) (EXPANSION)	0.5mm ²	Used for connect to remote control and extended output module. If connect CAN(L) to 120Ω, then there is no need to external connect 120Ω resistor.
	28.	CAN(H) (EXPANSION)	0.5mm ²	
	29.	120Ω (EXPANSION)	0.5mm ²	
W/L	30.	D+ Charge input	1.0mm ²	Charging generator D+ terminal input; Ground connected is not allowed.
	31.	MP1 (Magnetic pickup+)	0.5mm ²	Connect to speed sensor; Using shielding wire is recommended. MP1(-) internal connect B-.
	32.	MP1 (Magnetic pickup-)		
	33.	Water Temperature Sensor Input	1.0mm ²	Water temperature sensor input(resistance)
	34.	Oil Temperature Sensor Input	1.0mm ²	Oil temperature sensor input(resistance).
	35.	Oil Pressure Sensor Input	1.0mm ²	Oil pressure sensor input(resistance/current)
	36.	Flexible sensor 1	1.0mm ²	User configure (resistance/current/voltage)
	37.	Flexible sensor 2	1.0mm ²	User configure (resistance/current/voltage)
	38.	Flexible sensor 3	1.0mm ²	User configure (resistance/current/voltage)
	39.	DC5V	1.0mm ²	Supply power for voltage type sensors.
	40.	COM(B-) input	1.0mm ²	Input common port. Connect to (B-) inside
	41.	Emergency Shutdown Input	0.5mm ²	Controller shutdown urgently if input

Icon	No.	Function	Cable Size	Description
				active.
	42.	Start (G)	0.5mm ²	Digital input 7 Default Set: Remote start input.
	43.	Stop (H)	0.5mm ²	Digital input 8 Default Set: Stop input.
	44.	Aux. Input1 (A)	0.5mm ²	User configure Default Set: Local Mode input.
	45.	Aux. Input2 (B)	0.5mm ²	User configure Default Set: Remote Mode input.
	46.	Override (I)	0.5mm ²	Digital input 9 Default Set: Override input.
	47.	Fuel Leakage (J)	0.5mm ²	Digital input 10 Default Set: Fuel leakage input.
	48.	Aux. input 3 (C)	0.5mm ²	User configure
	49.	Aux. input 4 (D)	0.5mm ²	User configure
	50.	Aux. input 5 (E)	0.5mm ²	User configure
	51.	Aux. input 6 (F)	0.5mm ²	User configure
		52.	COM(B-) input	1.0mm ²
Power A Input	53.	B1-	1.0mm ²	Power supply A negative pole
	54.	B1+	1.0mm ²	Power supply A positive pole
Power B Input	55.	B2-	1.0mm ²	Power supply B negative pole
	56.	B2+	1.0mm ²	Power supply B positive pole
RS485	57.	RS485-(B)	0.5mm ²	PC programming and monitoring port (isolation type). Its single end earthed.
	58.	RS485+(A)	0.5mm ²	
	59.	RS485 Shield Ground	0.5mm ²	
CANBUS (ECU)	60.	CAN(L) (ECU)	0.5mm ²	Used for connect to ECU of engine with J1939 interface. If connect CAN(L) to 120Ω, then there is no need to external connect 120Ω resistor. (HMC6000A is unavailable)
	61.	CAN(H) (ECU)	0.5mm ²	
	62.	120Ω (ECU)	0.5mm ²	
LINK				Enables connection to PC monitoring software.

▲ Note: It is strictly prohibited to take out start battery when the engine is running. Failure to do so can create excessive DC input voltage and result in damage of destruction of equipment!

▲ Note: Compared with HMC6000A rear panel, HMC6000A 2 has a CANBUS (ECU) interface.

11 COMMUNICATION AND CONNECTION

11.1 RS485 AND LINK COMMUNICATION

HMC6000A/HMC6000A 2 genset controller has RS485 port and Link port which allows the controller to connect to open-type LAN. RS485 and Link applies ModBus communication protocol with the help of PC or DAS (Data Acquisition Systems) operational software provides easy to use marine engine monitoring system management scheme and enables remote control, remote measurement and remote communication.

11.2 CANBUS (EXPANSION) BUS COMMUNICATION

Various expansion modules can be connected to the controller via CANBUS (EXPANSION) port.

- DOUT16 Digital output module: The module connects to the main controller via CANBUS port. Main controller transfers the output condition data of digital output module to module to handle via CANBUS. All parameters of digital output port can be configured via main controller.
- HMC6000RM Remote control module: Remote control module can achieve control operations such as starting engine, stopping engine, etc. All kinds of parameters and records of the engine real-time display on remote controller.
- RPU560A Security module: The module connects to the main controller via CANBUS port. If security module receives no signal from the main controller for more than 1 second and the main controller failure input deactivates, security module will take over engine control; after that the engine will be stopped only by shutdown input or in case of overspeed. Module input function, output function and overspeed alarm threshold are user-set.

▲ Note: Remote control module can only be used in remote mode of the engine; in local mode remote control module only can check parameters and records but not control the engine.

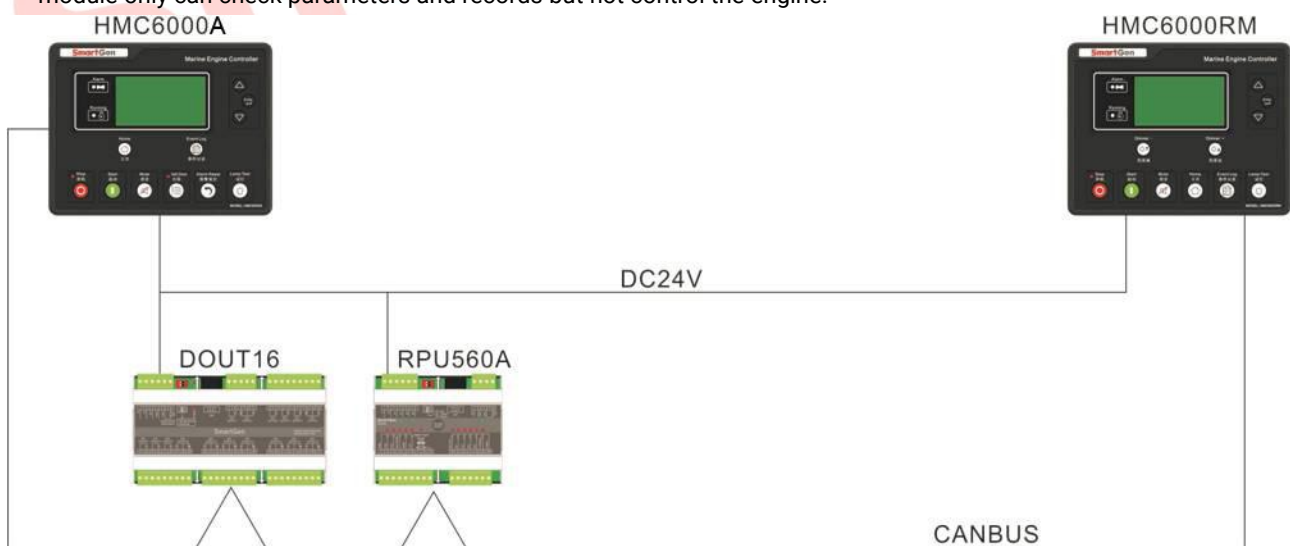

Fig.4 HMC6000A CANBUS Communication Diagram

11.3 CONTROLLER AND ENGINES CONNECTION (EXPANSION CANBUS)

A large number of J1939 engines can be controlled by the controller via CANBUS (ECU) port. Besides, at the same time users also can connect expansion module which makes it convenient and suitable for different working environments.

▲ **Note:** HMC6000 does not have this function.

11.3.1 CUMMINS ISB/ISBE

Table 19 Fuel Start Wiring Connection

Terminals of controller	Connector B	Remarks
Fuel relay output	39	
Start relay output	-	Connect to starter coil directly.
Programmable output port 1	Expand 30A relay, battery voltage of terminal 01,07,12,13 are supplied by relay.	ECU power; set programmable output 1 as "ECU power".

Table 20 9-Pin Connector Wiring Connection

Terminals of controller	9 pin connector	Remarks
CAN(H) (ECU)	SAE J1939 signal	Impedance 120Ω connecting line is recommended.
CAN(L) (ECU)	SAE J1939 return	Impedance 120Ω connecting line is recommended.

Engine type: **Cummins ISB**

11.3.2 CUMMINS QSL9

Compatible with CM850 engine controller module.

Table 21 Fuel Start Wiring Connection

Terminals of controller	50 pin connector	Remark
Fuel relay output	39	
Start relay output	-	Connect to starter coil directly.

Table 22 9-Pin Connector Wiring Connection

Terminals of controller	9 pin connector	Remark
CAN(H) (ECU)	SAE J1939 signal-C	Impedance 120Ω connecting line is recommended.
CAN(L) (ECU)	SAE J1939 return-D	Impedance 120Ω connecting line is recommended.

Engine type: **Cummins-CM850**

11.3.3 CUMMINS QSM11

Compatible with CM750 engine controller module. Engine types: QSM11 G1, QSM11 G2

Table 23 Fuel Start Wiring Connection

Terminals of controller	C1 connector	Remark
Fuel relay output	5&8	
Start relay output	-	Connect to starter coil directly.

Table 24 3-Pin Connector Wiring Connection

Terminals of controller	3 pin data link connector	Remark
CAN(H) (ECU)	A	Impedance 120Ω connecting line is recommended.
CAN(L) (ECU)	B	Impedance 120Ω connecting line is recommended.

Engine type: **Cummins ISB**

11.3.4 DETROIT DIESEL DDEC III / IV

Table 25 Engine Wiring Connection

Terminals of controller	Engine CAN port	Remark
Fuel relay output	Expand 30A relay; battery voltage of ECU is supplied by relay	
Start relay output	-	Connect to starter coil directly.
CAN(H) (ECU)	CAN(H)	Impedance 120Ω connecting line is recommended.
CAN(L) (ECU)	CAN(L)	Impedance 120Ω connecting line is recommended.

Engine type: **Common J1939**

11.3.5 DEUTZ EMR2

Table 26 Engine Wiring Connection

Terminals of controller	F connector	Remark
Fuel relay output	Expand 30A relay, battery voltage of terminal 14 is supplied by relay. Fuse is 16A.	
Start relay output	-	Connect to starter coil directly.
-	1	Connect to battery negative.
CAN(H) (ECU)	12	Impedance 120Ω connecting line is recommended.
CAN(L) (ECU)	13	Impedance 120Ω connecting line is recommended.

Engine type: **Volvo EDC4**

11.3.6 JOHN DEERE

Table 27 Engine Wiring Connection

Terminals of controller	21 pin connector	Remark
Fuel relay output	G, J	
Start relay output	D	
CAN(H) (ECU)	V	Impedance 120Ω connecting line is recommended.
CAN(L) (ECU)	U	Impedance 120Ω connecting line is recommended.

Engine type: **John Deere**

11.3.7 MTU MDEC

Compatible with MTU 2000 and 4000 series engines.

Table 28 Engine Wiring Connection

Terminals of controller	X1 connector	Remark
Fuel relay output	BE1	
Start relay output	BE9	
CAN(H)(ECU)	G	Impedance 120Ω connecting line is recommended.
CAN(L)(ECU)	F	Impedance 120Ω connecting line is recommended.

Engine type: **MTU-MDEC-303**

11.3.8 PERKINS

Compatible with ADEM3/ ADEM4 engine control modules. Engine types: 2306, 2506, 1106, and 2806.

Table 29 Engine Wiring Connection

Terminals of controller	Connector	Remark
Fuel relay output	1,10,15,33,34	
Start relay output	-	Connect to starter coil directly
CAN(H) (ECU)	31	Impedance 120Ω connecting line is recommended.
CAN(L) (ECU)	32	Impedance 120Ω connecting line is recommended.

Engine type: Perkins

11.3.9 SCANIA

Compatible with S6 engine control module. Engines: DC9, DC12, DC16.

Table 30 Engine Wiring Connection

Terminals of controller	B1 connector	Remark
Fuel relay output	3	
Start relay output	-	Connect to starter coil directly.
CAN(H) (ECU)	9	Impedance 120Ω connecting line is recommended.
CAN(L) (ECU)	10	Impedance 120Ω connecting line is recommended.

Engine type: Scania

11.3.10 VOLVO EDC3

Compatible with such engines as TAD1240, TAD1241, and TAD1242.

Table 31 Fuel Start Wiring Connection

Terminals of controller	"Stand alone" connector	Remark
Fuel relay output	H	
Start relay output	E	
Auxiliary output 1	P	Set auxiliary output 1 as "Preheating until cranking" and set preheating time as 5 seconds.

Table 32 CANBUS Wiring Connection

Terminals of controller	"Data bus" connector	Remark
CAN(H) (ECU)	1	Impedance 120Ω connecting line is recommended.
CAN(L) (ECU)	2	Impedance 120Ω connecting line is recommended.

Engine type: Volvo

11.3.11 VOLVO EDC4

Compatible engine types are TD520, TAD520 (optional), TD720, TAD720 (optional), TAD721, and TAD722.

Table 33 Engine Wiring Connection

Terminals of controller	Connector	Remark
Fuel relay output	Expand 30A relay, battery volt of terminal 14 is supplied by relay. Fuse is 16A.	
Start relay output	-	Connect to starter coil directly.
	1	Connect to battery negative.
CAN(H) (ECU)	12	Impedance 120Ω connecting line is recommended.
CAN(L) (ECU)	13	Impedance 120Ω connecting line is recommended.

Engine type: **Volvo EDC4**

11.3.12 VOLVO-EMS2

Compatible with the following Volvo engines: D9、D13、D16、EMS

Table 34 Engine Wiring Connection

Terminals of controller	Engine CAN port	Remark
Auxiliary output 2	5	ECU power supply Set auxiliary output 2 as "ECU Power Supply".
CAN(H) (ECU)	1(CAN H)	Impedance 120Ω connecting line is recommended.
CAN(L) (ECU)	2(CAN L)	Impedance 120Ω connecting line is recommended.

Input ports can be set with speed control function, auxiliary input port 1 can be set as speed up input, and auxiliary input port 2 can be set as speed down input. After the normal running, raise/drop speed functions can be achieved by digital input ports.

Engine type: **Volvo-EMS2**

11.3.13 BOSCH

Compatible with BOSCH common rail electronic engines.

Table 35 Engine Wiring Connection

Terminals of controller	42 pin engine port	Remark
Fuel relay output	1.40	Connect to engine ignition switch.
Start relay output	-	Connect to starter coil directly.
CAN(H) (EXPANSION)	1.35	Impedance 120Ω connecting line is recommended.
CAN(L) (EXPANSION)	1.34	Impedance 120Ω connecting line is recommended.

11.3.14 POWER WIRING CONNECTION

Table 36 Power Wiring Connection

Battery	2 pin engine port	Remark
Battery negative	1	Wire size: 2.5mm ²
Battery positive	2	Wire size: 2.5mm ²

Engine type: **BOSCH**

Please contact us if you have any questions about controller and ECU connection.

12 HMC6000A 2 APPLICATION DIAGRAM

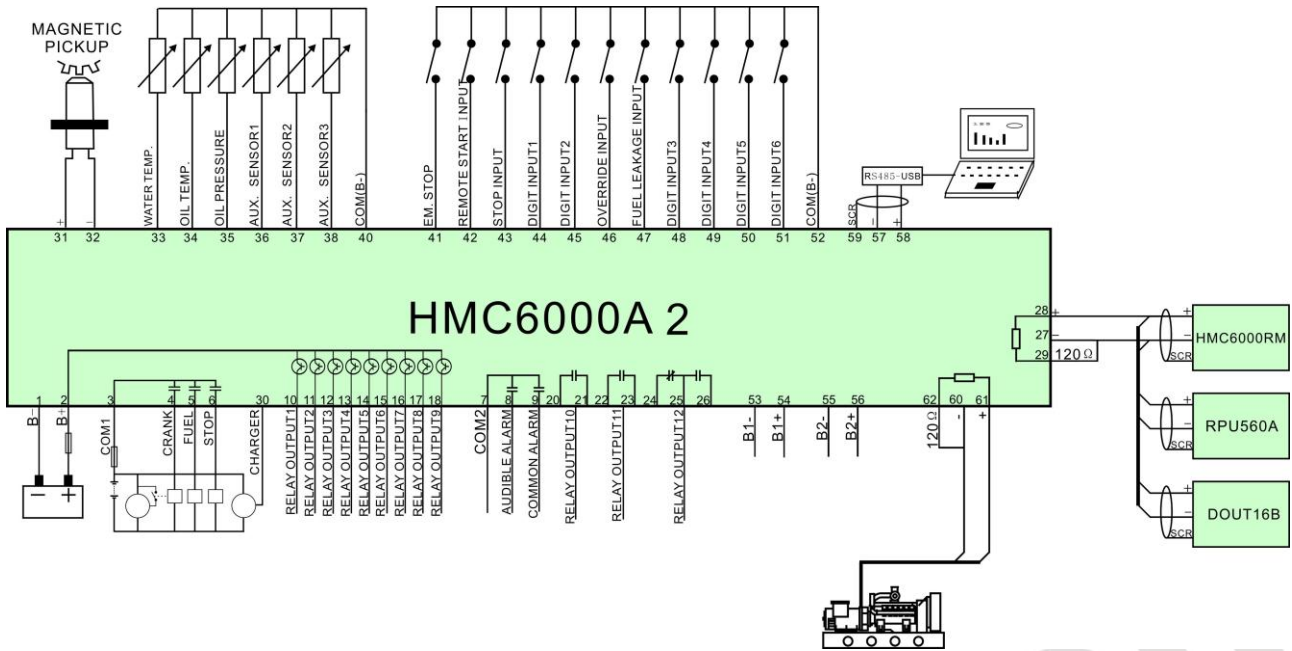

Fig.5 HMC6000A 2 Application Diagram

13 COMMISSIONING

Doing the following check before the system starting to run formally is recommended:

- Ensure all the connections are correct and wires diameter is suitable;
- Ensure that the controller DC power has fuse, controller's positive and negative connected to start battery are correct;
- Take proper action to prevent engine to crank success (e. g. Remove the connection wire of fuel valve). If checking is OK, make the start battery power on;
- Make the local mode active and then the controller enter into local mode. Press the Start button and the engine will start. If fail to start, genset will enter into ETS status automatically;
- Recover the action to prevent engine to crank success e. g. Connect wire of fuel valve), press start button again, and the engine will start. The engine will run from idle to formal if all works regularly. During this time, please watch the running status. If abnormal, stop engine and check all wires connection according to this manual;
- If there is any other question, please contact SmartGen's service.

14 INSTALLATION

14.1 FIXING CLIPS

Controller is panel built-in design; it is fixed by clips when installed.

- Withdraw the fixing clip screw (turn anticlockwise) until it reaches proper position;
- Pull the fixing clip backwards (towards the back of the module) ensuring two clips are inside their allotted slots;
- Turn the fixing clip screws clockwise until they are fixed on the panel.

▲ NOTE: Care should be taken not to over tighten the screws of fixing clips.

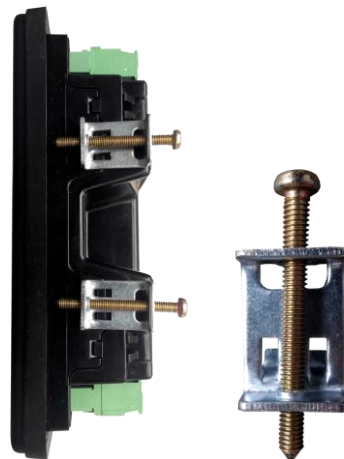

Fig.6 Fixing Clip Installation

14.2 OVERALL DIMENSIONS AND CUTOUT DIMENSIONS

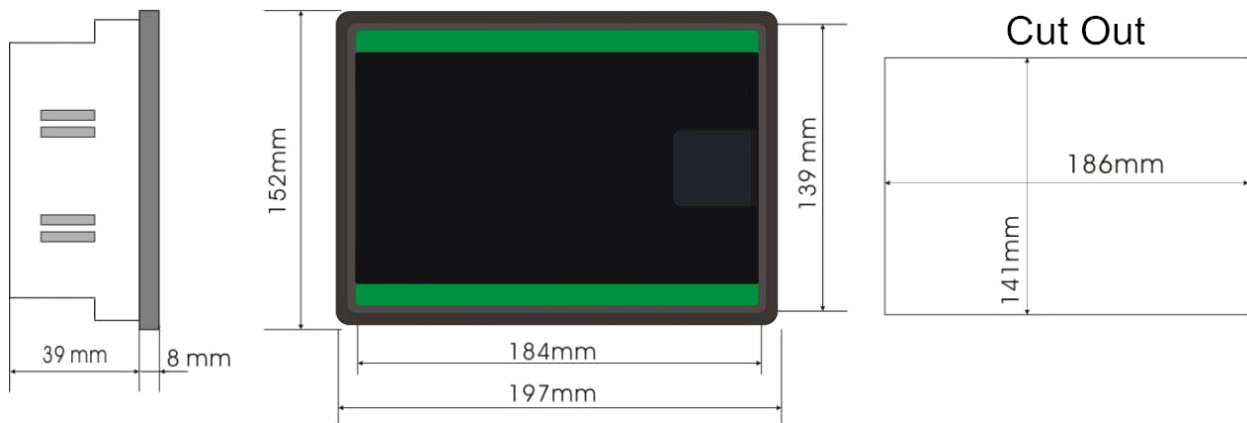

Fig.7 Overall and Cutout Dimensions

15 INSTALLATION CAUTIONS

15.1 BATTERY VOLTAGE INPUT

HMC6000A/HMC6000A 2 controller can suit for widely range of battery voltage DC (8~35) V. Negative of battery must be connected with the engine shell. The diameter of wire which is from power supply to battery must be over 2.5mm². If floating charge configured, please firstly connect output wires of charger to battery's positive and negative directly, then, connect wires from battery's positive and negative to controller's positive and negative input ports in order to prevent charge disturbing the controller's normal working.

15.2 SPEED SENSOR INPUT

Speed sensor is magnetic equipment which is installed on engine body for testing flywheel teeth number. 2 core shielding wire is used for the connection of the sensor and controller. The wire is supposed to be connected to 32 terminal of controller with one end and the other end hanging in the air. The other two signal lines connect separately to 31, 32 terminals. Speed sensor output voltage is supposed to be at AC (1-24) V (virtual value) when it is in full speed range, and AC12V (when in rated rotate speed) is recommended. When install the speed sensor, screw it to contact the flywheel firstly, inverse it with 1/3 circle, and then tighten the nut finally.

15.3 OUTPUT AND EXPANSION RELAY

All outputs of controller are relay contact output type. If expansion relays are needed, please add freewheel diode to both ends of expansion relay's coils (when coils of relay has DC current) or add resistance-capacitance return circuit (when coils of relay has AC current), in order to prevent charge disturbing the controller or others equipment.

15.4 SENSOR INPUT

All oil pressure sensor, auxiliary sensor1, auxiliary sensor2 and auxiliary sensor3 of HMC6000A /HMC6000A 2 series can be configured to current/power/resistance sensor (jumper switch over is as below). Water temperature sensor and oil temperature sensor is fixed resistor sensor.

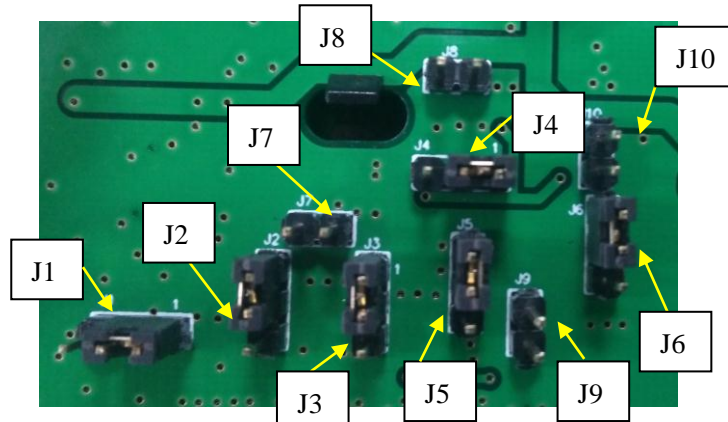

Fig. 8 Sensor Wire Jumper
Table 37 Wire Jumper List

Sensors	Jumper Hat	Resistor(Jumper)	Voltage(Jumper)	Current(Jumper)
OP Sensor	J3, J7	Connect to term.1,2 of J3	Connect to J7	Connect to term.2,3 of J3
Flexible Sensor1	J4, J8	Connect to term.1,2 of J4	Connect to J8	Connect to 2,3 of J4
Flexible Sensor2	J5, J9	Connect to term.1,2 of J5	Connect to J9	Connect to 2,3 of J5
Flexible Sensor3	J6, J10	Connect to term.1,2 of J6	Connect to J10	Connect to 2,3 of J6

Remark: Water temperature sensor and oil temperature sensor are resistance sensor that cannot be changed to others.

15.5 WITHSTAND VOLTAGE TEST

When controller has been installed in control panel, if need the high voltage test, please disconnect controller's all terminals in order to prevent high voltage into controller and damage it.

16 TROUBLESHOOTING

Table 38 Troubleshooting

Problem	Possible Solution
Controller no response with power.	Check starting batteries; Check controller connection wirings; Check DC fuse.
Genset shutdown	Check the water/cylinder temperature is too high or not.
Emergency shutdown	Check emergency shutdown button function.
Low oil pressure alarm after engine has fired.	Check oil pressure sensor and wiring.
High water temperature alarm after engine has fired.	Check water temperature sensor and its wiring.
Shutdown alarm when engine is running	Check relevant switch and its wiring according to the information on LCD; Check auxiliary digital input port.
Fail to start	Check fuel return circuit and its wiring; Check starting battery; Check speed sensor and its wiring; Consult engine manual.
Starter no respond	Check starter wiring; Check start battery.
RS485 communication failure	Check wiring; Check if COM port setting is right; Check if RS485 A and B wires are connected in the opposite way; Check if PC communication port is damaged; Putting a 120Ω resistance between RS485 A and B is recommended.
CANBUS communication failure	Check wiring; Check if CANBUS CANH and CANL wires are connected in the opposite way; Check if CANBUS CANH and CANL wires at both ends are connected in the opposite way; Putting a 120Ω resistance between CANBUS CANH and CANL is recommended.