



**SmartGen**  
ideas for power

# HGM9510N/HGM9530N PARALLELED GENSET CONTROLLER USER MANUAL



**SMARTGEN (ZHENGZHOU) TECHNOLOGY CO.,LTD.**



Chinese trademark

**SmartGen** English trademark

**SmartGen** — make your generator *smart*

**SmartGen Technology Co., Ltd.**

**No.28 Jinsuo Road**

**Zhengzhou City**

**Henan Province**

**P. R. China**

**Tel:** 0086-(0)371-67988888/67981888

0086-(0)371-67991553/67992951

0086-(0)371-67981000(overseas)

**Fax:** 0086-(0)371-67992952

**Web:** [www.smartgen.com.cn](http://www.smartgen.com.cn)

[www.smartgen.cn](http://www.smartgen.cn)

**Email:** [sales@smartgen.cn](mailto:sales@smartgen.cn)

All rights reserved. No part of this publication may be reproduced in any material form (including photocopying or storing in any medium by electronic means or other) without the written permission of the copyright holder.

Applications for the copyright holder's written permission to reproduce any part of this publication should be addressed to SmartGen Technology at the address above.

Any reference to trademarked product names used within this publication is owned by their respective companies.

SmartGen Technology reserves the right to change the contents of this document without prior notice.



**Table 1 Software Version**

Date	Version	Note
2018-11-12	1.0	Original release.
2019-08-22	1.1	Fixed typical wiring diagram.
2019-11-04	1.2	Added HGM9510N model.



This manual is only suits for HGM9510N/HGM9530N genset parallel unit.

**Table 2 Symbol Instruction**

Symbol	Instruction
 NOTE	Highlights an essential element of a procedure to ensure correctness.
 CAUTION	Indicates a procedure or practice, which, if not strictly observed, could result in damage or destruction of equipment.
 WARNING	Indicates a procedure or practice, which could result in injury to personnel or loss of life if not followed correctly.





# CONTENTS

1	OVERVIEW .....	6
2	PERFORMANCE AND CHARACTERISTICS .....	7
3	SPECIFICATION.....	9
4	OPERATION .....	11
4.1	INDICATOR LAMP .....	11
4.2	PUSHBUTTONS.....	12
4.3	LCD DISPLAY .....	13
4.3.1	MAIN DISPLAY .....	13
4.3.2	USER MENU AND PARAMETER SETTING.....	14
4.4	AUTO START/STOP OPERATION.....	15
4.5	MANUAL START/STOP OPERATION.....	16
4.6	SWITCH CONTROL PROCEDURES .....	16
4.6.1	MANUAL TRANSFER PROCEDURES .....	16
4.6.2	AUTOMATIC CONTROL PROCEDURE .....	17
5	PROTECTIONS .....	17
5.1	CONTROLLER ALARM TYPES.....	17
5.2	WARNING ALARMS.....	18
5.3	BLOCK ALARMS.....	24
5.4	SAFETY TRIP.....	29
5.5	SAFETY STOP ALARMS .....	33
5.6	TRIP ALARMS .....	38
5.7	TRIP AND STOP ALARM.....	43
5.8	SHUTDOWN ALARMS.....	48
6	WIRING CONNECTION .....	53
7	SCOPES AND DEFINITIONS OF PROGRAMMABLE PARAMETERS .....	56
7.1	CONTENTS AND SCOPES OF PARAMETERS.....	56
7.2	ENABLE DEFINITION OF PROGRAMMABLE OUTPUT PORTS .....	76
7.2.1	DEFINITION OF DIGITAL OUTPUT PORTS.....	76
7.2.2	DEFINED PERIOD OUTPUT .....	83
7.2.3	DEFINED COMBINATION OUTPUT .....	83
7.3	DEFINED CONTENTS OF PROGRAMMABLE INPUT PORTS .....	84
7.4	SELECTION OF SENSORS.....	87
7.5	CONDITIONS OF CRANK DISCONNECT SELECTION.....	88
8	PARAMETERS SETTING.....	88
9	SENSOR SETTING .....	89
10	COMMISSIONING .....	90
10.1	STEP 1: SINGLE UNIT DEBUGGING .....	90
10.2	STEP 2: MANUAL PARALLEL OPERATION OFF-LOAD .....	90
10.3	STEP 3: MANUAL PARALLEL OPERATION ON-LOAD.....	90
10.4	STEP 4: AUTOMATIC PARALLEL OPERATION .....	90



11	TYPICAL APPLICATION .....	91
12	POWER MANAGEMENT MODE .....	94
13	NEL TRIP DESCRIPTION .....	95
14	DUMMY LOAD CONNECTION .....	96
15	GROUND BREAKER CONTROL DESCRIPTION .....	97
16	PRIORITY RUNNING AND BALANCED RUNNING TIME DESCRIPTION .....	98
17	ECONOMICAL FUEL CONSUMPTION DESCRIPTION .....	99
18	STATIC PARALLEL CONNECTION.....	100
19	HEAVY LOAD REQUEST.....	101
20	CONTROLLER REDUNDANCY .....	102
21	INSTALLATION.....	103
22	CONNECTIONS OF CONTROLLER AND J1939 ENGINE .....	104
22.1	CUMMINS ISB/ISBE.....	104
22.2	CUMMINS QSL9 .....	104
22.3	CUMMINS QSM11 (IMPORT).....	105
22.4	CUMMINS QSX15-CM570 .....	105
22.5	CUMMINS GCS-MODBUS.....	105
22.6	CUMMINS QSM11 .....	106
22.7	CUMMINS QSZ13 .....	106
22.8	DETROIT DIESEL DDEC III/IV .....	107
22.9	DEUTZ EMR2.....	107
22.10	JOHN DEERE.....	107
22.11	MTU ADEC (SMART MODULE) .....	108
22.12	MTU ADEC(SAM MODULE) .....	108
22.13	PERKINS .....	108
22.14	SCANIA.....	109
22.15	VOLVO EDC3.....	109
22.16	VOLVO EDC4.....	110
22.17	VOLVO-EMS2 .....	110
22.18	YUCHAI .....	111
22.19	WEICHAI.....	111
23	FAULT FINDING .....	112



## 1 OVERVIEW

**HGM9510N/9530N** genset parallel controller is designed for manual/auto parallel system generators with similar or different capacities. Additionally, it is suitable for single unit constant power output and mains paralleling to realize automatic start/stop, parallel running, data measurement, alarm protection as well as remote control, remote measurement and remote communication functions. It fits with large LCD display, optional Chinese, English and other languages interface, and it is reliable and easy to use.

**HGM9510N/9530N** genset parallel controller has GOV and AVR control function, which can synchronize and share load automatically to parallel with gensets equipped with HGM9510N/9520N controller. Controller can precisely monitor all running status of all gensets, and when abnormal occasions occur, gensets can parallel off from the bus, and stop the gensets, in which process, fault status will be displayed on the LCD. Controller has SAE J1939 port, and can communicate with various ECU (Engine Control Unit) with J1939.

**HGM9510N/9530N** genset parallel controller can handle complex applications due to its controller redundancy function (not for HGM9510N), MSC redundancy function (not for HGM9510N), comprehensive fault protection function and flexible scheduled start/stop functions. It can be widely used in all types of automatic gen-set control system with compact structure, advanced circuits, simple connections and high reliability.



## 2 PERFORMANCE AND CHARACTERISTICS

- Main characteristics are as bellow:
- With ARM-based 32-bit SCM, high integration of hardware and more reliable;
- 240x128 LCD with backlight, multilingual interface (including English, Chinese or other languages) which can be chosen on site, making commissioning convenient for factory personnel;
- Improved LCD wear-resistance and scratch resistance due to hard screen acrylic;
- Silicon panel and pushbuttons for better operation in high/low temperature environment;
- Two RS485 communication ports enable remote control, remote measuring, remote communication via MODBUS protocol;
- Fitted with CANBUS port and can communicate with ECU equipped with J1939. Not only can you monitor frequently-used data (such as water temperature, oil pressure, engine speed, fuel consumption and so on) of ECU machine, but also control start, stop, raising speed and speed droop via CANBUS port;
- Suitable for 3-phase 4-wire, 3-phase 3-wire, single phase 2-wire, and 2-phase 3-wire systems with voltage 120/240V and frequency 50/60Hz;
- Collects and shows 3-phase voltage of Bus/Gen, Bus/Gen frequency, Gen 3-phase current, Gen power and Gen voltage harmonic parameters;
- For Bus, controller has loss of phase and phase sequence wrong detection functions; For generator, controller has over voltage, under voltage, over frequency, under frequency, high unbalanced voltage, high total harmonic distortion, over current, earth fault, high unbalanced current, low power factor, over power, reverse power, loss of excitation, loss of phase, phase sequence wrong detection functions;
- Synchronization parameters: voltage difference between bus and gen, frequency difference between bus and gen, phase angle difference between bus and gen;
- Multiple running modes in auto state: with load running, off load running, demand parallel running;
- Ramp on and ramp off function in paralleling/splitting;
- 3 fixed analogue sensor inputs (temperature, oil pressure and liquid level);
- 2 configurable analogue sensor inputs can be set as sensors of temperature, oil pressure or level;
- Oil pressure sensor and configurable sensor input 1 can directly connect with resistive/current/voltage sensors, while other sensor inputs can directly connect with resistive sensors, and for connecting voltage/current sensors, please make it clear before the order;
- More kinds of curves of temperature, oil pressure, level sensors can be used directly and users can define the sensor curves by themselves;
- Precisely collect various engine parameters, including temperature, engine oil pressure, fuel level, speed, battery voltage, charger voltage, total running time and total start times etc.;
- Control and protection function: automatic start/stop of the diesel genset, ATS(Auto Transfer Switch) control and perfect 2-class fault indication and protection function etc.;



- Parameter setting function: parameters can be modified by users and stored in internal EEPROM memory, and cannot be lost even in case of power outage; most of them can be adjusted from the front panel of the controller and all of them can be modified on PC by RS485 ports;
- Multiple crank disconnect conditions (speed, engine oil pressure, generator frequency) are optional;
- Wide power supply range DC(8~35)V, suitable for different starting battery voltage environment;
- Event log, real-time clock, scheduled start & stop function (allowing to start the genset once a day/week/month with load or not);
- Alarm data record function, which allows to record the genset data of 5 alarms;
- Accumulative total run time of A and B and total electric energy of A and B; Users can reset them and start afresh, providing convenience for users;
- Heater, cooler and fuel pump control functions;
- Maintenance function; maintenance time due actions can be set;
- All parameters apply digital adjustment, getting rid of conventional analogue modulation with normal potentiometer, and improving genset reliability and stability;
- IP65 waterproof level is achieved with the help of rubber-ring gasket between shell and control panel;
- Metal fixing clips employed to fix the controller and make it perform better under high temperature environment;
- Modular structure design, self-extinguishing ABS plastic shell, pluggable terminal, built-in mounting , compact structure with easy installation;



### 3 SPECIFICATION

**Table 3 Technical Specification**

Parameter	Details
Working Voltage	Range: DC8V - DC35V continuous, DC reverse connection protection Resolution: 0.1V Accuracy: 1%
Overall Consumption	<7W (Standby mode: ≤2.5W)
AC Voltage	Phase voltage Range: AC15V - AC360V (ph-N) Resolution: 0.1V Accuracy: 0.5%
	Wire voltage Range: AC30V - AC620V (ph- ph) Resolution: 0.1V Accuracy: 0.5%
AC Frequency	Range: 5Hz -75Hz Resolution: 0.01Hz Accuracy: 0.1Hz
AC Current	Rated: 5A Range: 0A – 10A Resolution: 0.1A Accuracy: 1%
Speed Sensor	Voltage Range: 1. 0 V - 24 V (RMS) Frequency Range: 5Hz – 10000Hz
Charger(D+) Voltage	Range: DC0V - DC60V continuous Resolution: 0.1V Accuracy: 1%
Analog Sensor	Resistor Input Range: 0Ω- 6000Ω Resolution: 0.1 Accuracy: 1Ω(below 300Ω)
	Voltage Input Range: 0 V - 5V Resolution: 0.001V Accuracy: 1%
	Current Input Range: 0 mA - 20mA Resolution: 0.01mA Accuracy: 1%
Fuel Output	16A DC24V DC power supply output(relay output)
Crank Output	16A DC24V DC power supply output(relay output)



Parameter	Details
Digital Output 1	8A DC30V DC power supply output (relay output)
Digital Output 2	8A DC30V DC power supply output (relay output)
Digital Output 3	8A DC30V DC power supply output (relay output)
Digital Output 4	8A DC250V volt-free output (relay output)
Digital Output 5	8A DC250V volt-free output (relay output)
Digital Output 6	8A DC250V volt-free output (relay output)
Digital Output 7	1A DC30V DC power supply output (transistor output)
Digital Output 8	1A DC30V DC power supply output (transistor output)
Digital Output 1-10	Low limit voltage is 1.2V; high limit voltage is 60V;
RS485	Isolated, half-duplex, 9600 baud rate, maximum communication length 1000m
Ethernet	Self-adapting 10/100Mbit
MSC CAN	Isolated, maximum communication length 250m; applying Belden 9841 cable or the equivalence;
EMC/CE Certification	EN 61326-1:2013
Vibration Test	5 - 8 Hz: $\pm 7.5$ mm 8 - 500 Hz: 2 g IEC 60068-2-6
Shock Test	50g, 11ms, half-sine, complete shock test from three directions, and 18 times shock for each test IEC 60068-2-27
Bump Test	25g, 16ms, self-sine IEC 60255-21-2
Production Compliance	According to EN 61010-1 installation category (over voltage category) III, 300V, pollution class 2, altitude 3000m
Case Dimensions	242 mm x 186 mm x 49 mm
Panel Cutout	214mm x 160mm
Working Conditions	Temperature: (-25~+70) $^{\circ}$ C      Relative Humidity: (20~93)%RH
Storage Conditions	Temperature:(-30~+80) $^{\circ}$ C
Protection Level	Front Enclosure: IP65 when rubber-ring gasket is installed between the enclosure and the control panel Rear Enclosure: IP20
Insulation Intensity	Apply AC2.2kV voltage between high voltage terminal and low voltage terminal and the leakage current is not more than 3mA within 1min.
Weight	1.1kg

**4 OPERATION**

**4.1 INDICATOR LAMP**



**Fig.1 HGM9510N/9530N Indication**

**NOTE:** Description for parts of indicators:

**Table 4 Alarm indicator Description**















Alarm Type	Alarm Indicator
Warning	Slow flashing (1 time per second)
Block	Slow flashing (1 time per second)
Safety Trip	Fast flashing (5 times per second)
Safety Trip and Stop	Fast flashing (5 times per second)
Trip	Fast flashing (5 times per second)
Trip and Stop	Fast flashing (5 times per second)
Shutdown	Fast flashing (5 times per second)
No Alarm	Extinguished



Running indicator: is normally illuminated after crank disconnection and before ETS stop and extinguished for other periods;

Gen normal indicator: is normally illuminated when the generator is normal; flashing when generator state is abnormal; extinguished when there is no generating power.

## 4.2 PUSHBUTTONS

**Table 5 Button Function Description**

Icons	Buttons	Description
	Stop	Stop the running generator in Auto/Manual mode; Reset alarm in stop mode; Lamp test (press at least 3 seconds); During stopping process, press this button again to stop the generator immediately.
	Start	Start the genset in Manual mode.
	Manual Mode	Press this key and the controller goes in Manual mode.
	Auto Mode	Press this key and controller goes in Auto mode.
	Mute/Reset Alarm	Remove the alarm sound; Remove the alarm by pressing for over 3s.
	Fn	Shortcut button by making groups with other buttons; or other function button (power button, stop button etc.)by setting.
	Close	Close the breaker in manual mode.
	Open	Open the breaker in manual mode.
	Up/Increase	1) Screen scroll; 2) Move up the cursor and increase value in setting menu.
	Down/Decrease	1) Screen scroll; 2) Move down the cursor and decrease value in setting menu.
	Left	1) Page scroll; 2) Left move the cursor in setting menu.
	Right	1) Page scroll; 2) Right move the cursor in setting menu.
	Set/Confirm	1) Enter setting screen; 2) Return to previous menu in setting menu.
	Exit	1) Return to main menu; 2) Return to previous menu in setting menu.





**NOTE:** Press  and  simultaneously in manual mode and it can force the generator to crank. At this time the controller shall not judge whether the genset start is successful or not according to the starting conditions. It is controlled by the operator. When operator observes that the engine has started, he/she should release the button and the start output will be deactivated. Safety on delay will be initiated.

**NOTE:** Regarding ECU genset, in Stop/Auto mode, Press  button and it shall power on the ECU (fuel output and ECU power output are active.).

**CAUTION:** Factory default password is "00318", and users can change it in case others change the advanced parameter settings. Please clearly remember the password after changing. If you forget it, please contact SmartGen services and send the PD information in the controller page of "ABOUT" to the service personnel.

### 4.3 LCD DISPLAY

#### 4.3.1 MAIN DISPLAY

Paging is applied for the main screen;   is used for page scroll and   for screen scroll.

**Main Screen** includes the following contents:

- Gen: voltage, frequency, current, active power, reactive power;
- Busbar: voltage, frequency; active power, reactive power;
- Engine: speed, temperature, engine oil pressure, battery voltage;
- Part of status displays;

**Status** page includes the following contents:

Genset status, and ATS status;

**Engine** page includes the following contents:

Engine speed, engine temperature, engine oil pressure, fuel level, configurable analog 1, configurable analog 2, battery voltage, charger voltage, accumulated running time, accumulated start times.

**NOTE:** If CAN BUS is connected and engine information is from J1939, this page also includes: coolant pressure, coolant level, fuel temperature, fuel pressure, inlet temperature, exhaust temperature, turbo pressure, fuel consumption, total fuel consumption and so on. (Different engines have different parameters.)

**Generator** page includes the following contents:

Phase voltage, wire voltage, frequency, phase sequence, current, active power of different phases, total active power and percentage, reactive power of different phases, total reactive power and percentage, apparent power of different phases, total apparent power, power factor of different phases, average power factor, accumulated electric power, total power of multi-genset; ground current and percentage, unbalance current and percentage, unbalance voltage and percentage.

**NOTE:**

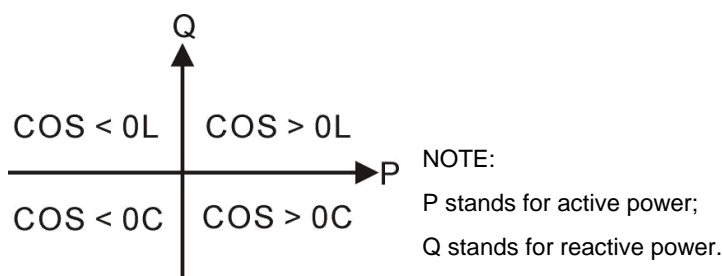

**Fig. 2 Power Factor Display Description**



**Table 6 Power Factor Display Description**

Power Factor	Conditions	Active Power	Reactive Power	Remark
COS>0L	P>0,Q>0	Input	Input	Load is resistive induction.
COS>0C	P>0,Q<0	Input	Output	Load is resistive capacitance.
COS<0L	P<0,Q>0	Output	Input	Load equals an under excitation generator.
COS<0C	P<0,Q<0	Output	Output	Load equals an over excitation generator.

**▲NOTES:**

1. Input active power, and generator send active power to load.
2. Output active power, and load supply electricity to generator.
3. Input reactive power, and generator send reactive power to load.
4. Output reactive power, and load send reactive power to generator.

**Busbar** page includes the following contents:

Phase voltage, wire voltage, frequency, phase sequence; available power.

**Snyc.** page includes the following contents:

Voltage difference, frequency difference, phase position difference, active power output and percentage, reactive power output and percentage, GOV voltage output percentage, AVR voltage output percentage and MSC status.

**Alarm** page:

**▲NOTE:** For ECU alarms and shutdown alarms, if the alarm information is displayed, check the engine according to it. Otherwise, please check the generator manual according to SPN alarm code.

**Event log** page:

Make records about all start/stop events (alarm events except warnings, manual start/stop events) and the real time when events occur;

**Others** page includes the following contents:

Time and Date, maintenance due (if configured), input/output port status, communication indication and Ethernet configuration (if configured).

**About** page includes the following contents:

Release software version, hardware version, and product PD number.

**4.3.2 USER MENU AND PARAMETER SETTING**



Press  key for more than 1s and it enters user menu.

- Parameter Setting

After inputting the correct password (factory default password is 00318) you can enter the parameter setting screen.

- Language

Optional Simplified Chinese, English and others.

- Commissioning

On load, off load and users-defined commissioning are optional. Defined commissioning can be configured regarding load on or load off, commissioning time, and which mode it shall return after commissioning (manual mode, auto mode and stop mode).



- Clear users' accumulation

It can clear total running time A and B, total electric energy A and B.

- Main/Redundant module (Not for HGM9510N)

It is optional as to whether main module is active or redundant module is active.

#### 4.4 AUTO START/STOP OPERATION

Press the  button and the indicator beside is illuminated, which means the genset is at Auto Start Mode.

##### Automatic Start Sequence:

- 1) When 'remote start'(on-load) is active, 'start delay' timer is initiated;
- 2) "Start Delay" countdown will be displayed on genset status page;
- 3) When start delay is over, preheating relay is energized (if configured), 'preheat delay XX s' information will be displayed on genset status page;
- 4) After the above delay, the fuel relay is energized, and then one second later, the start relay is engaged. During the 'start time', if the genset does not start, then fuel relay and start relay stops outputting, and enter 'crank rest time', waiting for next crank;
- 5) Should the start continues beyond the set attempts, the controller issues 'start failure' and stops the genset and at the same time alarm page on LCD displays 'start failure alarm';
- 6) If it starts during the attempts, it enters 'safety on time', and during this period Low Oil Pressure, High Temperature, Under speed and Charge Alternator Failure alarms are all inactive; After 'safety on time', it enters 'start idle delay' (if configured);
- 7) During 'start idle delay', under speed, under frequency, under voltage alarms are inhibited. When this delay is over, 'warming up delay' is initiated (if configured);
- 8) When one genset is running and 'warming up delay' is over, if generator status is normal, its indicator will be illuminated. If generator voltage and frequency have reached on-load requirements, then the generator close relay will be energized; the genset will take load and generator power indicator will be illuminated, and generator will enter normal running status. If voltage or frequency is abnormal, the controller will initiate alarm (alarm information will be displayed on LCD);
- 9) When the gensets is running in parallel and 'warming up delay' is over:
  - a) If busbar has not voltage signal, then the controller will issue a close status signal to other gensets waiting for combination in parallel. Then generator close relay will output, avoiding to close the breaker at the same time;
  - b) If busbar has voltage or other gensets are already closed, the controller will adjust speed and voltage through GOV and AVR to synchronize the gensets to the busbar; when synchronism requirements has been achieved, breaker close signal will be initiated and the genset will be paralleled with the busbar. Once they are paralleled, the controller will control the generator to gradually accelerate and share load with other paralleled gensets.

**▲NOTE:** When Remote Start is applied to start (Off Load), the procedure is the same as the above. But generator close relay is deactivated, and moreover, genset is off load. When Remote Start is used to start, the genset will start based on the set priority sequence, and then synchronize, put them in parallel and share the load in the busbar automatically.

##### Automatic Stop Sequence:



- 1) When the Remote Start signal is removed, the 'stop delay' is initiated;
- 2) Once this 'stop delay' has expired, the module will ramp the load from the generator to other sets



and issue breaker open signal. The 'cooling delay' is then initiated. During this time if the remote start signal is active again, then the controller enters paralleled status again; When 'cooling delay' is over, it the genset enters 'stop idle delay';

- 3) During 'stop idle delay' (if configured), the idling speed relay is energized;
- 4) 'ETS solenoid hold' begins, ETS relay is energized while fuel relay is de-energized, and complete stop is detected automatically;
- 5) 'fail to stop delay' begins, and complete stop is detected automatically;
- 6) When generator is stopped completely, 'after stop delay' will be initiated. Otherwise, 'fail to stop' alarm is initiated and the corresponding alarm information is displayed on LCD. (If generator stops successfully after 'fail to stop' alarm has initiated, 'after stop delay' will be initiated and the alarm will be removed.);
- 7) Generator is placed into its standby mode after its 'after stop delay';

#### 4.5 MANUAL START/STOP OPERATION

1. MANUAL START: Manual mode is selected by pressing the  button; a LED besides the button will be illuminated to confirm the operation; then press  button to start the gen-set; it can detect crank disconnect condition and generator accelerates to high-speed running automatically. With high temperature, low oil pressure, over speed and abnormal voltage during generator running, controller can protect genset to stop quickly (please refer to No.3~9 of **Automatic Start Sequence** for detailed procedures).
2. MANUAL STOP: Press  and it can shut down the running generators. (Please refer to No.2~7 of **Automatic Start Sequence** for detailed procedures).

**▲NOTE:** In "manual mode", for the procedures of ATS please refer to **Switch Control Procedure** of generator in this manual.

#### 4.6 SWITCH CONTROL PROCEDURES

##### 4.6.1 MANUAL TRANSFER PROCEDURES

When controller is in **Manual** mode, the switch control procedures will start through manual transfer procedures. Users can control the loading transfer of ATS via pressing button to switch on or off.

**Breaker Close Operation:** During genset normal running, press  if generator voltage and frequency have reached on-load requirements.

- 1) When one genset is running, generator closing relay outputs;
- 2) When gensets are running in parallel,
  - a) If busbar has not voltage signal, then the controller will issue a close status signal to other gensets waiting for combination in parallel. Then generator close relay will output, avoiding to close the breaker at the same time;
  - b) If busbar has voltage or other gensets are already closed, the controller will adjust speed and voltage through GOV and AVR to synchronize the gensets to the busbar; when synchronism requirements has been achieved, breaker close signal will be initiated and the genset will be paralleled with the busbar. Once they are paralleled, the controller will control the generator to





gradually accelerate and share load with other paralleled gensets.

**Breaker Open Operation:** Press the  button,

- 1) When one genset is running, the controller sends open breaker signal.
- 2) When gensets are running in parallel, the controller shall transfer the loading to other gensets and then issue open signal.

#### 4.6.2 AUTOMATIC CONTROL PROCEDURE

When controller is in Auto mode, the switch control procedure is automatic control procedure.

**NOTE:** The auxiliary close input should be configured necessarily and make sure the connection is correct.

### 5 PROTECTIONS

#### 5.1 CONTROLLER ALARM TYPES

**Table 7 Controller Alarm Types**

Alarm Type/Action	Open CB Directly	Open CB After Unloading	Stop Directly	Stop After Cooling	Reset Alarm
Warning	-	-	-	-	Auto
Block	-	-	-	-	Manual
Safety Trip	-	●	-	-	Manual
Safety Stop	-	●	-	●	Manual
Trip	●	-	-	-	Manual
Trip and Stop	●	-	-	●	Manual
Alarm Shutdown	●	-	●	-	Manual



## 5.2 WARNING ALARMS

When controller detects the warning alarm, it only issues warning, and the genset does not open and shutdown. When the warning signal disappears, it is removed automatically.

**Table 8 Warning Alarms**

No	Type	Description
1	Over Speed	When this is enabled, and the controller detects that the engine speed is above the pre-set limit, it will initiate a warning. It is always detected.
2	Under Speed	When this is enabled and the controller detects that the engine speed is below the pre-set limit, it will initiate a warning. It is detected after 'warming up' and before 'stop idle'.
3	Loss of Speed Signal	When the controller detects the engine speed is 0, it shall issue a warning. It is detected after 'safety on time' before 'ETS solenoid hold'.
4	Gen Over Frequency	When this is enabled, and the controller detects the frequency is above the preset limit, it shall issue a warning. It is detected always.
5	Gen Under Frequency	When this is enabled, and the controller detects the frequency is below the preset limit, it shall issue a warning. It is detected after 'warming up time' before 'stop idle time'.
6	Gen Over Voltage	When this is enabled, and the controller detects the voltage is above the preset limit, it shall issue a warning. It is always detected.
7	Genset Under Voltage	When this is enabled, and the controller detects the voltage is below the preset limit, it shall issue a warning. It is detected after 'warming up time' before 'stop idle time'.
8	Gen Over Current	When this is enabled, and the controller detects the current is above the preset limit, it shall issue a warning. It is always detected.
9	Negative Sequence Current	When this is enabled, and the controller detects the value is above the preset limit, it shall issue a warning. It is always detected.
10	Earth Fault	When this is enabled, and the controller detects the earth current is above the preset limit, it shall issue a warning. It is always detected.
11	Reverse Power	When this is enabled, and the controller detects the reverse power (negative) is above the preset limit, it shall issue a warning. It is always detected.
12	Over Power	When this is enabled, and the controller detects the genset power (positive) is above the preset limit, it shall issue a warning. It is always detected.
13	Loss Excitation	When this is enabled, and the controller detects the genset reactive



No	Type	Description
		power (negative) is above the preset limit, it shall issue a warning. It is always detected.
14	ECU Alarm	When the controller receives the engine alarm signal from J1939, it shall issue a warning. It is always detected.
15	Temp. Sensor Open	When the controller detects the sensor circuit is open, it shall issue a warning. It is always detected.
16	Engine Temp High	When this is enabled, and the controller detects the temp. is above the preset limit, it shall issue a warning. It is detected after 'safety on time' before 'ETS solenoid hold'.
17	Engine Temp Low	When this is enabled, and the controller detects the temp. is below the preset limit, it shall issue a warning. It is detected after 'safety on time' before 'ETS solenoid hold'.
18	Oil Pressure Sensor Open	When the controller detects the sensor circuit is open, it shall issue a warning. It is always detected.
19	Oil Pressure Low	When this is enabled, and the controller detects the pressure is below the preset limit, it shall issue a warning. It is detected after 'safety on time' before 'ETS solenoid hold'.
20	Oil Pressure Sensor Wrong	When voltage or current input is selected for the curve type of the controller, and the controller detects input signal is abnormal, it shall issue a warning, and meanwhile the curve is transferred to resistor type to prevent damaging the controller. It is detected always.
21	Fuel Level Sensor Open	When the controller detects the sensor circuit is open, it shall issue a warning. It is always detected.
22	Fuel Level Low	When this is enabled, and the controller detects the level is below the preset limit, it shall issue a warning. It is always detected.
23	Flex. Sensor 1 Open	When the controller detects the sensor circuit is open, it shall issue a warning. It is always detected.
24	Flex. Sensor 1 High	When over high warning is enabled, and the controller detects the sensor value is above the preset upper limit, it shall issue a warning. It is detected after 'safety on time' before 'ETS solenoid hold' when the sensor is selected as temperature sensor and pressure sensor; It is always detected when the sensor is selected as fuel level sensor.
25	Flex. Sensor 1 Low	When over low warning is enabled, and the controller detects the sensor value is below the preset low limit, it shall issue a warning. It is detected after 'safety on time' before 'ETS solenoid hold' when the sensor is selected as temperature sensor and pressure sensor;



No	Type	Description
		It is always detected when the sensor is selected as fuel level sensor.
26	Flex. Sensor 1 Wrong	When voltage or current input is selected for the curve type of the controller, and the controller detects input signal is abnormal, it shall issue a warning, and meanwhile the curve is transferred to resistor type to prevent damaging the controller. It is detected always.
27	Flex. Sensor 2 Open	When the controller detects the sensor circuit is open, it shall issue a warning. It is always detected.
28	Flex. Sensor 2 High	When over high warning is enabled, and the controller detects the sensor value is above the preset upper limit, it shall issue a warning. It is detected after 'safety on time' before 'ETS solenoid hold' when the sensor is selected as temperature sensor and pressure sensor; It is always detected when the sensor is selected as fuel level sensor.
29	Flex. Sensor 2 Low	When over low warning is enabled, and the controller detects the sensor value is below the preset low limit, it shall issue a warning. It is detected after 'safety on time' before 'ETS solenoid hold' when the sensor is selected as temperature sensor and pressure sensor; It is always detected when the sensor is selected as fuel level sensor.
30	Fail to Stop	After 'fail to stop delay' is over, if the genset does not stop completely, it will initiate a warning alarm. It is detected when the genset is normally running.
31	Charge Alternator Failure	When this is enabled and the controller detects that charger voltage is below the pre-set limit, it will initiate a warning alarm. It is detected when the genset is normally running.
32	Battery Over Volt	When this is enabled, and the controller detects the battery voltage is above the preset limit, it shall issue a warning signal. It is always detected.
33	Battery Under Volt	When this is enabled, and the controller detects the battery voltage is below the preset limit, it shall issue a warning signal. It is always detected.
34	Fail to Sync.	If the controller doesn't detect sync. signal within the pre-set time, it will initiate a warning alarm. It is detected when GCB closes.
35	GOV Reach Limit	When the controller's GOV output reaches the upper limit or lower limit, it will initiate a warning alarm. It is detected when the genset is running.
36	AVR Reach Limit	When the controller's AVR output reaches the high limit or low limit, it will initiate a warning alarm. It is detected when the genset is running.
37	Gen Breaker Alarm	When 'Gen Closed Aux' is not set for the controller input port, the controller will initiate a warning alarm. It is always detected.



No	Type	Description
38	Mains Over Freq	When the controller detects that the mains frequency is above the pre-set value, it will initiate a warning alarm. It is detected after 'Mains Parallel Mode' is active and after 'Gen closed'.
39	Mains Under Freq	When the controller detects the mains frequency has fallen below the pre-set value, it will initiate a warning alarm. It is detected after 'Mains Parallel Mode' is active and after 'Gen closed'.
40	Mains Over Voltage	When the controller detects that the mains voltage has exceeded the pre-set value, it will initiate a warning alarm. It is detected after 'Mains Parallel Mode' is active and after 'Gen closed'.
41	Mains Under Voltage	When the controller detects that the mains voltage has fallen below the pre-set value, it will initiate a warning alarm. It is detected after 'Mains Parallel Mode' is active and after 'Gen closed'.
42	Mains ROCOF	When the controller detects mains ROCOF is above the pre-set value, it will initiate a warning alarm. It is detected after 'Mains Parallel Mode' is active and after 'Gen closed'.
43	Mains Vector Shift	When the controller detects mains voltage vector shift is above the pre-set value, it will initiate a warning alarm. It is detected after 'Mains Parallel Mode' is active and after 'Gen closed'.
44	Freq Error Too High	When the controller detects the generator frequency and busbar frequency is above 8Hz, it will initiate a warning alarm. It is detected during synchronous close.
45	MSC Too Few Sets	When the controller detects the number of the parallel gensets is smaller than the set minimum parallel number, it will initiate a warning alarm. There are 2 possible reasons: a) the communication wire between the controllers is detached, leading to communication interrupt. b) controller of parallel gen-sets is not powered on. It is always detected.
46	Maintenance Due	When this is enabled and countdown time is 0, it will initiate a warning alarm. It is detected when the genset is running.
47	MSC1 Com Fail	When the controller detects there is data losing of other gensets in MSC1 bus, it will initiate a warning alarm. It is always detected.
48	MSC2 Com Fail	When the controller detects there is data losing of other gensets in MSC2 bus, it will initiate a warning alarm. It is always detected.
49	Digital Input Alarm	When the digital input port is set users-defined and if it is active, the controller will initiate a warning for the input port. It is detected in the detection range set for the input port.
50	PLC Functions Alarm	When PLC function is set users-defined and if it is active, the controller will initiate a warning. It is detected in the detection range set by the PLC function.
51	DIN16 Com. Fail	When DIN16 communication is enabled and the controller cannot



No	Type	Description
		receive the communication data, it will initiate a warning. It is always detected.
52	DIN16 Input Alarm	When DIN16 input is set users-defined and if it is active, the controller will initiate a warning. It is detected in the detection range set in the input.
53	DOUT16 Com. Fail	When DOUT16 communication is enabled and the controller cannot receive the communication data, it will initiate a warning. It is always detected.
54	AIN24 Com. Fail	When AIN24 communication is enabled and the controller cannot receive the communication data, it will initiate a warning. It is always detected.
55	AIN24 Cylinder Temp. High	When this is enabled and the controller detects cylinder temperature has exceeded the pre-set value, it will initiate a warning alarm. It is detected after 'safety on time' before 'ETS solenoid hold'.
56	AIN24 Exhaust Temp. High	When this is enabled and the controller detects exhaust temperature has exceeded the pre-set value, it will initiate a warning alarm. It is detected after 'safety on time' before 'ETS solenoid hold'.
57	AIN24 Cylinder Temp. Difference High	When this is enabled and the controller detects cylinder temp. difference has exceeded the pre-set value, it will initiate a warning alarm. It is detected after 'safety on time' before 'ETS solenoid hold'.
58	AIN24 Sensor Open	When the controller detects the sensor circuit is open, it shall issue a warning. It is always detected.
59	AIN24 Sensor High	When over high warning is enabled, and the controller detects the sensor value is above the preset upper limit, it shall issue a warning. It is detected after 'safety on time' before 'ETS solenoid hold' when the sensor is selected as temperature sensor and pressure sensor; It is always detected when the sensor is selected as fuel level sensor.
60	AIN24 Sensor Low	When over low warning is enabled, and the controller detects the sensor value is below the preset lower limit, it shall issue a warning. It is detected after 'safety on time' before 'ETS solenoid hold' when the sensor is selected as temperature sensor and pressure sensor; It is always detected when the sensor is selected as fuel level sensor.
61	Power Factor Low	When this is enabled and the controller detects that the generator power factor has fallen below the pre-set value, it will initiate a warning alarm. It is always detected.
62	THD High	When this is enabled and the controller detects that the THD has exceeded the pre-set value, it will initiate a warning alarm. It is always detected.
63	Gen Volt Unbalance	When this is enabled and the controller detects that the voltage unbalanced value has exceeded the pre-set value, it will initiate a warning alarm. It is always detected.



No	Type	Description
64	Ground Relay Close Fail	When controller detects that ground relay close fails, that is, breaker close input is inactive after ground relay close outputs, and then it will initiate a warning alarm. It is detected when ground relay is closing.
65	Ground Relay Open Fail	When controller detects that ground relay open fails, that is, breaker open input is inactive after ground relay open outputs, and then it will initiate a warning alarm. It is detected when ground relay is opening.

SmartGen



### 5.3 BLOCK ALARMS

When the controller detects block signals, it only issues warning and the genset does not shutdown and not open. Users need to reset alarms manually.

**Table 9 Block Alarms**

No	Type	Description
1	Over Speed	When this is enabled, and the controller detects that the genset speed is above the pre-set limit, it will initiate a block alarm. It is always detected.
2	Under Speed	When this is enabled and the controller detects that the genset speed is below the pre-set limit, it will initiate a block alarm. It is detected after 'warming up' and before 'stop idle'.
3	Loss of Speed Signal	When the controller detects the genset speed is 0, it shall issue a block alarm. It is detected after 'safety on time' and before 'ETS solenoid hold'.
4	Gen Over Frequency	When this is enabled, and the controller detects the genset frequency is above preset limit, it shall issue a block alarm. It is detected always.
5	Gen Under Frequency	When this is enabled, and the controller detects the frequency is below the preset limit, it shall issue a block alarm. It is detected after 'warming up' and before 'stop idle'.
6	Gen Over Voltage	When this is enabled, and the controller detects the genset voltage is above preset limit, it shall issue a block alarm. It is detected always.
7	Genset Under Voltage	When this is enabled, and the controller detects the voltage is below the preset limit, it shall issue a block alarm. It is detected after 'warming up' and before 'stop idle'.
8	Gen Over Current	When this is enabled, and the controller detects the genset current is above preset limit, it shall issue a block alarm. It is detected always.
9	Negative Sequence Current	When this is enabled, and the controller detects the unbalanced current is above preset limit, it shall issue a block alarm. It is detected always.
10	Earth Fault	When this is enabled, and the controller detects the earth current is above the preset limit, it shall issue a block alarm. It is always detected.
11	Reverse Power	When this is enabled, and the controller detects the reverse power (negative) is above the preset limit, it shall issue a block alarm. It is always detected.
12	Over Power	When this is enabled, and the controller detects the genset power (positive) is above the preset limit, it shall issue a block alarm. It is always detected.
13	Loss Excitation	When this is enabled, and the controller detects the genset reactive





No	Type	Description
		power (negative) is above the preset limit, it shall issue a block alarm. It is always detected.
14	ECU Alarm	When the controller receives the engine alarm signal from J1939, it shall issue a block alarm. It is always detected.
15	Temp. Sensor Open	When the controller detects the sensor circuit is open, it shall issue a block alarm. It is always detected.
16	Engine Temp High	When this is enabled, and the controller detects the temp. is above the preset limit, it shall issue a block alarm. It is detected after 'safety on time' before 'ETS solenoid hold'.
17	Engine Temp Low	When this is enabled, and the controller detects the temp. is below the preset limit, it shall issue a block alarm. It is detected after 'safety on time' before 'ETS solenoid hold'.
18	Oil Pressure Sensor Open	When the controller detects the sensor circuit is open, it shall issue a block alarm. It is always detected.
19	Oil Pressure Low	When this is enabled, and the controller detects the pressure is below the preset limit, it shall issue a block alarm. It is detected after 'safety on time' before 'ETS solenoid hold'.
20	Oil Pressure Sensor Wrong	When voltage or current input is selected for the curve type of the controller, and the controller detects input signal is abnormal, it shall issue a block alarm, and meanwhile the curve is transferred to resistor type to prevent damaging the controller. It is detected always.
21	Fuel Level Sensor Open	When the controller detects the sensor circuit is open, it shall issue a block alarm. It is always detected.
22	Fuel Level Low	When this is enabled, and the controller detects the level is below the preset limit, it shall issue a block alarm. It is always detected.
23	Flex. Sensor 1 Open	When the controller detects the sensor circuit is open, it shall issue a block alarm. It is always detected.
24	Flex. Sensor 1 High	When over high block alarm is enabled, and the controller detects the sensor value is above the preset upper limit, it shall issue a block alarm. It is detected after 'safety on time' before 'ETS solenoid hold' when the sensor is selected as temperature sensor and pressure sensor; It is always detected when the sensor is selected as fuel level sensor.
25	Flex. Sensor 1 Low	When over low block alarm is enabled, and the controller detects the sensor value is below the preset low limit, it shall issue a block alarm. It is detected after 'safety on time' before 'ETS solenoid hold' when the sensor is selected as temperature sensor and pressure sensor;



No	Type	Description
		It is always detected when the sensor is selected as fuel level sensor.
26	Flex. Sensor 1 Wrong	When voltage or current input is selected for the curve type of the controller, and the controller detects input signal is abnormal, it shall issue a block alarm, and meanwhile the curve is transferred to resistor type to prevent damaging the controller. It is detected always.
27	Flex. Sensor 2 Open	When the controller detects the sensor circuit is open, it shall issue a block alarm. It is always detected.
28	Flex. Sensor 2 High	When over high block alarm is enabled, and the controller detects the sensor value is above the preset upper limit, it shall issue a block alarm. It is detected after 'safety on time' before 'ETS solenoid hold' when the sensor is selected as temperature sensor and pressure sensor; It is always detected when the sensor is selected as fuel level sensor.
29	Flex. Sensor 2 Low	When over low block alarm is enabled, and the controller detects the sensor value is below the preset low limit, it shall issue a block alarm. It is detected after 'safety on time' before 'ETS solenoid hold' when the sensor is selected as temperature sensor and pressure sensor; It is always detected when the sensor is selected as fuel level sensor.
30	Charge Alternator Failure	When this is enabled, and the controller detects the charger voltage value is below the preset limit, it shall issue a block alarm. It is detected when the genset is normally running.
31	Battery Over Volt	When this is enabled, and the controller detects the battery voltage is above the preset limit, it shall issue a block signal. It is always detected.
32	Battery Under Volt	When this is enabled, and the controller detects the battery voltage is below the preset limit, it shall issue a block signal. It is always detected.
33	Fail to Sync.	If the controller doesn't detect sync. signal within the pre-set time, it will initiate a block alarm. It is detected when GCB closes.
34	MSC Too Few Sets	When the controller detects the number of the paralleled gensets is smaller than the set minimum paralleled number, it will initiate a block alarm. There are 2 possible reasons: a) the communication wire between the controllers is detached, leading to communication interrupt. b) the controller of paralleled gen-sets is not powered on. It is always detected.
35	Maintenance Due	When this is enabled and countdown time is 0, it will initiate a block alarm. It is detected when the genset is running.
36	Digital Input Alarm	When the digital input port is set users-defined and if it is active, the controller will initiate a block signal for the input port. It is detected in the detection range set for the input port.



No	Type	Description
37	PLC Functions Alarm	When PLC function is set users-defined and if it is active, the controller will initiate a block signal. It is detected in the detection range set by the PLC function.
38	DIN16 Com. Fail	When DIN16 communication is enabled and the controller cannot receive the communication data, it will initiate a block signal. It is always detected.
39	DIN16 Input Alarm	When DIN16 input is set users-defined and if it is active, the controller will initiate a block signal. It is detected in the detection range set in the input.
40	DOUT16 Com. Fail	When DOUT16 communication is enabled and the controller cannot receive the communication data, it will initiate a block signal. It is always detected.
41	AIN24 Com. Fail	When AIN24 communication is enabled and the controller cannot receive the communication data, it will initiate a block signal. It is always detected.
42	AIN24 Cylinder Temp. High	When this is enabled and the controller detects cylinder temperature has exceeded the pre-set value, it will initiate a block alarm. It is detected after 'safety on time' before 'ETS solenoid hold'.
43	AIN24 Exhaust Temp. High	When this is enabled and the controller detects exhaust temperature has exceeded the pre-set value, it will initiate a block alarm. It is detected after 'safety on time' before 'ETS solenoid hold'.
44	AIN24 Cylinder Temp. Difference High	When this is enabled and the controller detects cylinder temp. difference has exceeded the pre-set value, it will initiate a block alarm. It is detected after 'safety on time' before 'ETS solenoid hold'.
45	AIN24 Sensor Open	When the controller detects the sensor circuit is open, it shall issue a block alarm. It is always detected.
46	AIN24 Sensor High	When over high alarm is enabled, and the controller detects the sensor value is above the preset upper limit, it shall issue a block alarm. It is detected after 'safety on time' before 'ETS solenoid hold' when the sensor is selected as temperature sensor and pressure sensor; It is always detected when the sensor is selected as fuel level sensor.
47	AIN24 Sensor Low	When over low alarm is enabled, and the controller detects the sensor value is below the preset lower limit, it shall issue a block alarm. It is detected after 'safety on time' before 'ETS solenoid hold' when the sensor is selected as temperature sensor and pressure sensor; It is always detected when the sensor is selected as fuel level sensor.
48	Power Factor Low	When this is enabled and the controller detects that the generator power factor has fallen below the pre-set limit, it will initiate a block alarm. It is always detected.
49	THD High	When this is enabled and the controller detects that the THD has exceeded the pre-set limit, it will initiate a block alarm. It is always detected.



No	Type	Description
50	Gen Volt Unbalance	When this is enabled and the controller detects that the voltage unbalanced value has exceeded the pre-set limit, it will initiate a block alarm. It is always detected.
51	Ground Relay Close Fail	When controller detects that ground relay close fails, that is, breaker close input is inactive after ground relay close outputs, and then it will initiate a block alarm. It is detected when ground relay is closing.
52	Ground Relay Open Fail	When controller detects that ground relay open fails, that is, breaker open input is inactive after ground relay open outputs, and then it will initiate a block alarm. It is detected when ground relay is opening.
53	Main Module Failure	When the controller detects the main controller fails, it will initiate a block alarm.

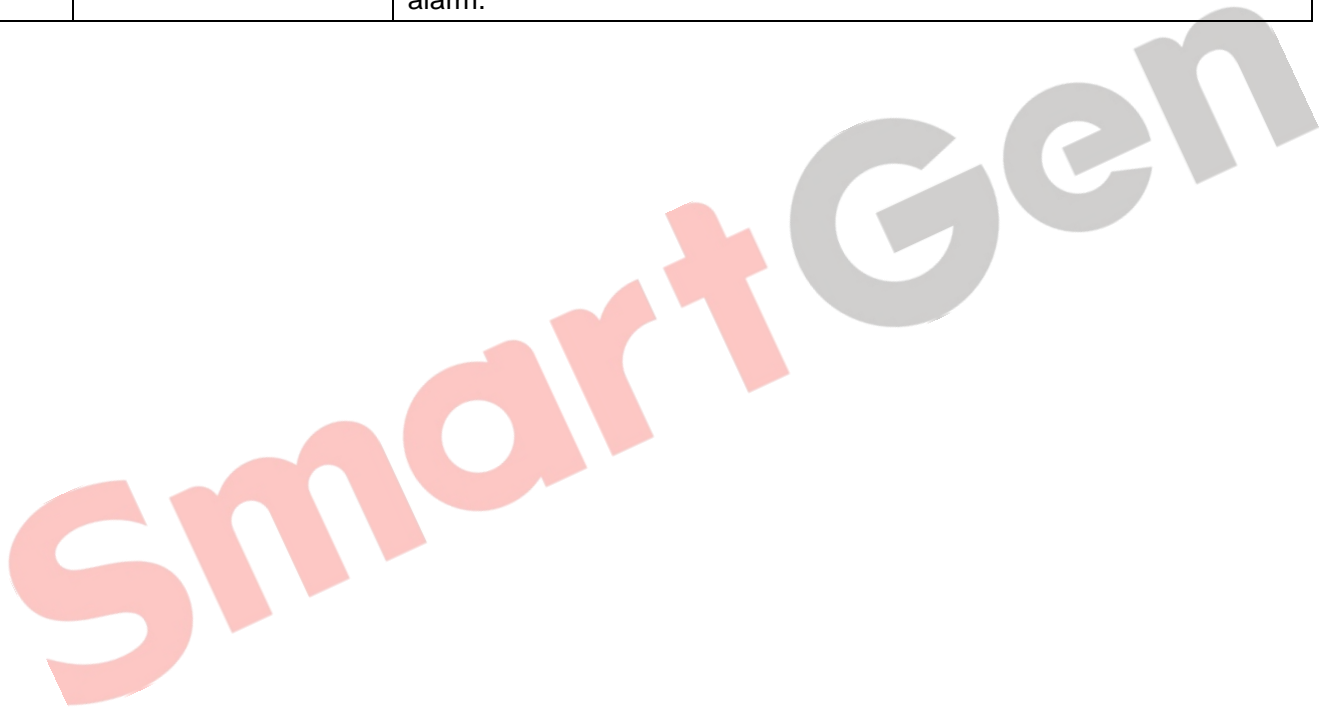



## 5.4 SAFETY TRIP

When controller detects safety trip signals, it will open breaker after soft unloading but not stop the genset. Users need to reset alarms manually.

**Table 10 Safety Trip**

No	Type	Description
1	Over Speed	When this is enabled, and the controller detects that the genset speed is above the pre-set limit, it will initiate an alarm signal. It is always detected.
2	Under Speed	When this is enabled and the controller detects that the genset speed is below the pre-set limit, it will initiate an alarm signal. It is detected after 'warming up' and before 'stop idle'.
3	Loss of Speed Signal	When the controller detects the genset speed is 0, it shall issue an alarm signal. It is detected after 'safety on time' and before 'ETS solenoid hold'.
4	Gen Over Frequency	When this is enabled, and the controller detects the genset frequency is above preset limit, it shall issue an alarm signal. It is detected always.
5	Gen Under Frequency	When this is enabled, and the controller detects the frequency is below the preset limit, it shall issue an alarm signal. It is detected after 'warming up' and before 'stop idle'.
6	Gen Over Voltage	When this is enabled, and the controller detects the genset voltage is above preset limit, it shall issue an alarm signal. It is detected always.
7	Genset Under Voltage	When this is enabled, and the controller detects the voltage is below the preset limit, it shall issue an alarm signal. It is detected after 'warming up' and before 'stop idle'.
8	Gen Over Current	When this is enabled, and the controller detects the genset current is above preset limit, it shall issue an alarm signal. It is detected always.
9	Negative Sequence Current	When this is enabled, and the controller detects the unbalanced current is above preset limit, it shall issue an alarm signal. It is detected always.
10	Earth Fault	When this is enabled, and the controller detects the earth current is above the preset limit, it shall issue an alarm signal. It is always detected.
11	Reverse Power	When this is enabled, and the controller detects the reverse power (negative) is above the preset limit, it shall issue an alarm signal. It is always detected.
12	Over Power	When this is enabled, and the controller detects the genset power (positive) is above the preset limit, it shall issue an alarm signal. It is always detected.
13	Loss Excitation	When this is enabled, and the controller detects the genset reactive



No	Type	Description
		power (negative) is above the preset limit, it shall issue an alarm signal. It is always detected.
14	ECU Alarm	When the controller receives the engine alarm signal from J1939, it shall issue an alarm signal. It is always detected.
15	Temp. Sensor Open	When the controller detects the sensor circuit is open, it shall issue an alarm signal. It is always detected.
16	Engine Temp High	When this is enabled, and the controller detects the temp. is above the preset limit, it shall issue an alarm signal. It is detected after 'safety on time' before 'ETS solenoid hold'.
17	Engine Temp Low	When this is enabled, and the controller detects the temp. is below the preset limit, it shall issue an alarm signal. It is detected after 'safety on time' before 'ETS solenoid hold'.
18	Oil Pressure Sensor Open	When the controller detects the sensor circuit is open, it shall issue an alarm signal. It is always detected.
19	Oil Pressure Low	When this is enabled, and the controller detects the pressure is below the preset limit, it shall issue an alarm signal. It is detected after 'safety on time' before 'ETS solenoid hold'.
20	Oil Pressure Sensor Wrong	When voltage or current input is selected for the curve type of the controller, and the controller detects input signal is abnormal, it shall issue an alarm signal, and meanwhile the curve is transferred to resistor type to prevent damaging the controller. It is detected always.
21	Fuel Level Sensor Open	When the controller detects the sensor circuit is open, it shall issue an alarm signal. It is always detected.
22	Fuel Level Low	When this is enabled, and the controller detects the level is below the preset limit, it shall issue an alarm signal. It is always detected.
23	Flex. Sensor 1 Open	When the controller detects the sensor circuit is open, it shall issue an alarm signal. It is always detected.
24	Flex. Sensor 1 High	When over high alarm is enabled, and the controller detects the sensor value is above the preset upper limit, it shall issue an alarm signal. It is detected after 'safety on time' before 'ETS solenoid hold' when the sensor is selected as temperature sensor and pressure sensor; It is always detected when the sensor is selected as fuel level sensor.
25	Flex. Sensor 1 Low	When over low alarm is enabled, and the controller detects the sensor value is below the preset low limit, it shall issue an alarm signal. It is detected after 'safety on time' before 'ETS solenoid hold' when the sensor is selected as temperature sensor and pressure sensor;



No	Type	Description
		It is always detected when the sensor is selected as fuel level sensor.
26	Flex. Sensor 1 Wrong	When voltage or current input is selected for the curve type of the controller, and the controller detects input signal is abnormal, it shall issue an alarm signal, and meanwhile the curve is transferred to resistor type to prevent damaging the controller. It is detected always.
27	Flex. Sensor 2 Open	When the controller detects the sensor circuit is open, it shall issue an alarm signal. It is always detected.
28	Flex. Sensor 2 High	When over high alarm is enabled, and the controller detects the sensor value is above the preset upper limit, it shall issue an alarm signal. It is detected after 'safety on time' before 'ETS solenoid hold' when the sensor is selected as temperature sensor and pressure sensor; It is always detected when the sensor is selected as fuel level sensor.
29	Flex. Sensor 2 Low	When over low alarm is enabled, and the controller detects the sensor value is below the preset low limit, it shall issue an alarm signal. It is detected after 'safety on time' before 'ETS solenoid hold' when the sensor is selected as temperature sensor and pressure sensor; It is always detected when the sensor is selected as fuel level sensor.
30	Charge Alternator Failure	When this is enabled, and the controller detects the charger voltage value is below the preset limit, it shall issue an alarm signal. It is detected when the genset is normally running.
31	Battery Over Volt	When this is enabled, and the controller detects the battery voltage is above the preset limit, it shall issue an alarm signal. It is always detected.
32	Battery Under Volt	When this is enabled, and the controller detects the battery voltage is below the preset limit, it shall issue an alarm signal. It is always detected.
33	Fail to Sync.	If the controller doesn't detect sync. signal within the pre-set time, it will initiate an alarm signal. It is detected when GCB closes.
34	MSC Too Few Sets	When the controller detects the number of the paralleled gensets is smaller than the set minimum paralleled number, it will initiate an alarm signal. There are 2 possible reasons: a) the communication wire between the controllers is detached, leading to communication interrupt. b) the controller of paralleled gen-sets is not powered on. It is always detected.
35	Maintenance Due	When this is enabled and countdown time is 0, it will initiate an alarm signal. It is detected when the genset is running.
36	Digital Input Alarm	When the digital input port is set users-defined and if it is active, the controller will initiate an alarm signal for the input port. It is detected in the detection range set for the input port.



No	Type	Description
37	PLC Functions Alarm	When PLC function is set users-defined and if it is active, the controller will initiate an alarm signal. It is detected in the detection range set by the PLC function.
38	DIN16 Com. Fail	When DIN16 communication is enabled and the controller cannot receive the communication data, it will initiate an alarm signal I. It is always detected.
39	DIN16 Input Alarm	When DIN16 input is set users-defined and if it is active, the controller will initiate an alarm signal. It is detected in the detection range set in the input.
40	DOUT16 Com. Fail	When DOUT16 communication is enabled and the controller cannot receive the communication data, it will initiate an alarm signal. It is always detected.
41	AIN24 Com. Fail	When AIN24 communication is enabled and the controller cannot receive the communication data, it will initiate an alarm signal. It is always detected.
42	AIN24 Cylinder Temp. High	When this is enabled and the controller detects cylinder temperature has exceeded the pre-set value, it will initiate an alarm signal. It is detected after 'safety on time' before 'ETS solenoid hold'.
43	AIN24 Exhaust Temp. High	When this is enabled and the controller detects exhaust temperature has exceeded the pre-set value, it will initiate an alarm signal. It is detected after 'safety on time' before 'ETS solenoid hold'.
44	AIN24 Cylinder Temp. Difference High	When this is enabled and the controller detects cylinder temp. difference has exceeded the pre-set value, it will initiate an alarm signal. It is detected after 'safety on time' before 'ETS solenoid hold'.
45	AIN24 Sensor Open	When the controller detects the sensor circuit is open, it shall issue an alarm signal. It is always detected.
46	AIN24 Sensor High	When over high alarm is enabled, and the controller detects the sensor value is above the preset upper limit, it shall issue an alarm signal. It is detected after 'safety on time' before 'ETS solenoid hold' when the sensor is selected as temperature sensor and pressure sensor; It is always detected when the sensor is selected as fuel level sensor.
47	AIN24 Sensor Low	When over low alarm is enabled, and the controller detects the sensor value is below the preset lower limit, it shall issue an alarm signal. It is detected after 'safety on time' before 'ETS solenoid hold' when the sensor is selected as temperature sensor and pressure sensor; It is always detected when the sensor is selected as fuel level sensor.
48	Power Factor Low	When this is enabled and the controller detects that the generator power factor has fallen below the pre-set limit, it will initiate an alarm signal. It is always detected.
49	THD High	When this is enabled and the controller detects that the THD has exceeded the pre-set limit, it will initiate an alarm signal. It is always detected.





No	Type	Description
50	Gen Volt Unbalance	When this is enabled and the controller detects that the voltage unbalanced value has exceeded the pre-set limit, it will initiate an alarm signal. It is always detected.
51	Ground Relay Close Fail	When controller detects that ground relay close fails, that is, breaker close input is inactive after ground relay close outputs, and then it will initiate an alarm signal. It is detected when ground relay is closing.
52	Ground Relay Open Fail	When controller detects that ground relay open fails, that is, breaker open input is inactive after ground relay open outputs, and then it will initiate an alarm signal. It is detected when ground relay is opening.

### 5.5 SAFETY TRIP AND STOP ALARMS

When controller detects safety stop signals, it will open breaker after soft unloading and genset stops after cooling. Users need to reset alarms manually.

**Table 11 Safety Trip and Stop Alarms**

No	Type	Description
1	Over Speed	When this is enabled, and the controller detects that the genset speed is above the pre-set limit, it will initiate an alarm signal. It is always detected.
2	Under Speed	When this is enabled and the controller detects that the genset speed is below the pre-set limit, it will initiate an alarm signal. It is detected after 'warming up' and before 'stop idle'.
3	Loss of Speed Signal	When the controller detects the genset speed is 0, it shall issue an alarm signal. It is detected after 'safety on time' and before 'ETS solenoid hold'.
4	Gen Over Frequency	When this is enabled, and the controller detects the genset frequency is above preset limit, it shall issue an alarm signal. It is detected always.
5	Gen Under Frequency	When this is enabled, and the controller detects the frequency is below the preset limit, it shall issue an alarm signal. It is detected after 'warming up' and before 'stop idle'.
6	Gen Over Voltage	When this is enabled, and the controller detects the genset voltage is above preset limit, it shall issue an alarm signal. It is detected always.
7	Genset Under Voltage	When this is enabled, and the controller detects the voltage is below the preset limit, it shall issue an alarm signal. It is detected after 'warming up' and before 'stop idle'.
8	Gen Over Current	When this is enabled, and the controller detects the genset current is above preset limit, it shall issue an alarm signal. It is detected always.



No	Type	Description
9	Negative Sequence Current	When this is enabled, and the controller detects the unbalanced current is above preset limit, it shall issue an alarm signal. It is detected always.
10	Earth Fault	When this is enabled, and the controller detects the earth current is above the preset limit, it shall issue an alarm signal. It is always detected.
11	Reverse Power	When this is enabled, and the controller detects the reverse power (negative) is above the preset limit, it shall issue an alarm signal. It is always detected.
12	Over Power	When this is enabled, and the controller detects the genset power (positive) is above the preset limit, it shall issue an alarm signal. It is always detected.
13	Loss Excitation	When this is enabled, and the controller detects the genset reactive power (negative) is above the preset limit, it shall issue an alarm signal. It is always detected.
14	ECU Alarm	When the controller receives the engine alarm signal from J1939, it shall issue an alarm signal. It is always detected.
15	Temp. Sensor Open	When the controller detects the sensor circuit is open, it shall issue an alarm signal. It is always detected.
16	Engine Temp High	When this is enabled, and the controller detects the temp. is above the preset limit, it shall issue an alarm signal. It is detected after 'safety on time' before 'ETS solenoid hold'.
17	Engine Temp Low	When this is enabled, and the controller detects the temp. is below the preset limit, it shall issue an alarm signal. It is detected after 'safety on time' before 'ETS solenoid hold'.
18	Oil Pressure Sensor Open	When the controller detects the sensor circuit is open, it shall issue an alarm signal. It is always detected.
19	Oil Pressure Low	When this is enabled, and the controller detects the pressure is below the preset limit, it shall issue an alarm signal. It is detected after 'safety on time' before 'ETS solenoid hold'.
20	Oil Pressure Sensor Wrong	When voltage or current input is selected for the curve type of the controller, and the controller detects input signal is abnormal, it shall issue an alarm signal, and meanwhile the curve is transferred to resistor type to prevent damaging the controller. It is detected always.
21	Fuel Level Sensor Open	When the controller detects the sensor circuit is open, it shall issue an alarm signal. It is always detected.
22	Fuel Level Low	When this is enabled, and the controller detects the level is below the preset limit, it shall issue an alarm signal.



No	Type	Description
		It is always detected.
23	Flex. Sensor 1 Open	When the controller detects the sensor circuit is open, it shall issue an alarm signal. It is always detected.
24	Flex. Sensor 1 High	When over high alarm is enabled, and the controller detects the sensor value is above the preset upper limit, it shall issue an alarm signal. It is detected after 'safety on time' before 'ETS solenoid hold' when the sensor is selected as temperature sensor and pressure sensor; It is always detected when the sensor is selected as fuel level sensor.
25	Flex. Sensor 1 Low	When over low alarm is enabled, and the controller detects the sensor value is below the preset low limit, it shall issue an alarm signal. It is detected after 'safety on time' before 'ETS solenoid hold' when the sensor is selected as temperature sensor and pressure sensor; It is always detected when the sensor is selected as fuel level sensor.
26	Flex. Sensor 1 Wrong	When voltage or current input is selected for the curve type of the controller, and the controller detects input signal is abnormal, it shall issue an alarm signal, and meanwhile the curve is transferred to resistor type to prevent damaging the controller. It is detected always.
27	Flex. Sensor 2 Open	When the controller detects the sensor circuit is open, it shall issue an alarm signal. It is always detected.
28	Flex. Sensor 2 High	When over high alarm is enabled, and the controller detects the sensor value is above the preset upper limit, it shall issue an alarm signal. It is detected after 'safety on time' before 'ETS solenoid hold' when the sensor is selected as temperature sensor and pressure sensor; It is always detected when the sensor is selected as fuel level sensor.
29	Flex. Sensor 2 Low	When over low alarm is enabled, and the controller detects the sensor value is below the preset low limit, it shall issue an alarm signal. It is detected after 'safety on time' before 'ETS solenoid hold' when the sensor is selected as temperature sensor and pressure sensor; It is always detected when the sensor is selected as fuel level sensor.
30	Charge Alternator Failure	When this is enabled, and the controller detects the charger voltage value is below the preset limit, it shall issue an alarm signal. It is detected when the genset is normally running.
31	Battery Over Volt	When this is enabled, and the controller detects the battery voltage is above the preset limit, it shall issue an alarm signal. It is always detected.
32	Battery Under Volt	When this is enabled, and the controller detects the battery voltage is below the preset limit, it shall issue an alarm signal. It is always detected.
33	Fail to Sync.	If the controller doesn't detect sync. signal within the pre-set time, it will initiate an alarm signal.



No	Type	Description
		It is detected when GCB closes.
34	MSC Too Few Sets	When the controller detects the number of the paralleled gensets is smaller than the set minimum paralleled number, it will initiate an alarm signal. There are 2 possible reasons: a) the communication wire between the controllers is detached, leading to communication interrupt. b) the controller of paralleled gen-sets is not powered on. It is always detected.
35	Maintenance Due	When this is enabled and countdown time is 0, it will initiate an alarm signal. It is detected when the genset is running.
36	Digital Input Alarm	When the digital input port is set users-defined and if it is active, the controller will initiate an alarm signal for the input port. It is detected in the detection range set for the input port.
37	PLC Functions Alarm	When PLC function is set users-defined and if it is active, the controller will initiate an alarm signal. It is detected in the detection range set by the PLC function.
38	DIN16 Com. Fail	When DIN16 communication is enabled and the controller cannot receive the communication data, it will initiate an alarm signal I. It is always detected.
39	DIN16 Input Alarm	When DIN16 input is set users-defined and if it is active, the controller will initiate an alarm signal. It is detected in the detection range set in the input.
40	DOUT16 Com. Fail	When DOUT16 communication is enabled and the controller cannot receive the communication data, it will initiate an alarm signal. It is always detected.
41	AIN24 Com. Fail	When AIN24 communication is enabled and the controller cannot receive the communication data, it will initiate an alarm signal. It is always detected.
42	AIN24 Cylinder Temp. High	When this is enabled and the controller detects cylinder temperature has exceeded the pre-set value, it will initiate an alarm signal. It is detected after 'safety on time' before 'ETS solenoid hold'.
43	AIN24 Exhaust Temp. High	When this is enabled and the controller detects exhaust temperature has exceeded the pre-set value, it will initiate an alarm signal. It is detected after 'safety on time' before 'ETS solenoid hold'.
44	AIN24 Cylinder Temp. Difference High	When this is enabled and the controller detects cylinder temp. difference has exceeded the pre-set value, it will initiate an alarm signal. It is detected after 'safety on time' before 'ETS solenoid hold'.
45	AIN24 Sensor Open	When the controller detects the sensor circuit is open, it shall issue an alarm signal. It is always detected.
46	AIN24 Sensor High	When over high alarm is enabled, and the controller detects the sensor value is above the preset upper limit, it shall issue an alarm signal. It is detected after 'safety on time' before 'ETS solenoid hold' when the



No	Type	Description
		sensor is selected as temperature sensor and pressure sensor; It is always detected when the sensor is selected as fuel level sensor.
47	AIN24 Sensor Low	When over low alarm is enabled, and the controller detects the sensor value is below the preset lower limit, it shall issue an alarm signal. It is detected after 'safety on time' before 'ETS solenoid hold' when the sensor is selected as temperature sensor and pressure sensor; It is always detected when the sensor is selected as fuel level sensor.
48	Power Factor Low	When this is enabled and the controller detects that the generator power factor has fallen below the pre-set limit, it will initiate an alarm signal. It is always detected.
49	THD High	When this is enabled and the controller detects that the THD has exceeded the pre-set limit, it will initiate an alarm signal. It is always detected.
50	Gen Volt Unbalance	When this is enabled and the controller detects that the voltage unbalanced value has exceeded the pre-set limit, it will initiate an alarm signal. It is always detected.
51	Ground Relay Close Fail	When controller detects that ground relay close fails, that is, breaker close input is inactive after ground relay close outputs, and then it will initiate an alarm signal. It is detected when ground relay is closing.
52	Ground Relay Open Fail	When controller detects that ground relay open fails, that is, breaker open input is inactive after ground relay open outputs, and then it will initiate an alarm signal. It is detected when ground relay is opening.



## 5.6 TRIP ALARMS

When controller detects trip alarms, it will open breaker directly but not stop the genset. Users need to reset alarms manually.

**Table 12 Trip Alarms**

No	Type	Description
1	Over Speed	When this is enabled, and the controller detects that the genset speed is above the pre-set limit, it will initiate an alarm signal. It is always detected.
2	Under Speed	When this is enabled and the controller detects that the genset speed is below the pre-set limit, it will initiate an alarm signal. It is detected after 'warming up' and before 'stop idle'.
3	Loss of Speed Signal	When the controller detects the genset speed is 0, it shall issue an alarm signal. It is detected after 'safety on time' and before 'ETS solenoid hold'.
4	Gen Over Frequency	When this is enabled, and the controller detects the genset frequency is above preset limit, it shall issue an alarm signal. It is detected always.
5	Gen Under Frequency	When this is enabled, and the controller detects the frequency is below the preset limit, it shall issue an alarm signal. It is detected after 'warming up' and before 'stop idle'.
6	Gen Over Voltage	When this is enabled, and the controller detects the genset voltage is above preset limit, it shall issue an alarm signal. It is detected always.
7	Genset Under Voltage	When this is enabled, and the controller detects the voltage is below the preset limit, it shall issue an alarm signal. It is detected after 'warming up' and before 'stop idle'.
8	Gen Over Current	When this is enabled, and the controller detects the genset current is above preset limit, it shall issue an alarm signal. It is detected always.
9	Negative Sequence Current	When this is enabled, and the controller detects the unbalanced current is above preset limit, it shall issue an alarm signal. It is detected always.
10	Earth Fault	When this is enabled, and the controller detects the earth current is above the preset limit, it shall issue an alarm signal. It is always detected.
11	Reverse Power	When this is enabled, and the controller detects the reverse power (negative) is above the preset limit, it shall issue an alarm signal. It is always detected.
12	Over Power	When this is enabled, and the controller detects the genset power (positive) is above the preset limit, it shall issue an alarm signal. It is always detected.
13	Loss Excitation	When this is enabled, and the controller detects the genset reactive



No	Type	Description
		power (negative) is above the preset limit, it shall issue an alarm signal. It is always detected.
14	ECU Alarm	When the controller receives the engine alarm signal from J1939, it shall issue an alarm signal. It is always detected.
15	Temp. Sensor Open	When the controller detects the sensor circuit is open, it shall issue an alarm signal. It is always detected.
16	Engine Temp High	When this is enabled, and the controller detects the temp. is above the preset limit, it shall issue an alarm signal. It is detected after 'safety on time' before 'ETS solenoid hold'.
17	Engine Temp Low	When this is enabled, and the controller detects the temp. is below the preset limit, it shall issue an alarm signal. It is detected after 'safety on time' before 'ETS solenoid hold'.
18	Oil Pressure Sensor Open	When the controller detects the sensor circuit is open, it shall issue an alarm signal. It is always detected.
19	Oil Pressure Low	When this is enabled, and the controller detects the pressure is below the preset limit, it shall issue an alarm signal. It is detected after 'safety on time' before 'ETS solenoid hold'.
20	Oil Pressure Sensor Wrong	When voltage or current input is selected for the curve type of the controller, and the controller detects input signal is abnormal, it shall issue an alarm signal, and meanwhile the curve is transferred to resistor type to prevent damaging the controller. It is detected always.
21	Fuel Level Sensor Open	When the controller detects the sensor circuit is open, it shall issue an alarm signal. It is always detected.
22	Fuel Level Low	When this is enabled, and the controller detects the level is below the preset limit, it shall issue an alarm signal. It is always detected.
23	Flex. Sensor 1 Open	When the controller detects the sensor circuit is open, it shall issue an alarm signal. It is always detected.
24	Flex. Sensor 1 High	When over high alarm is enabled, and the controller detects the sensor value is above the preset upper limit, it shall issue an alarm signal. It is detected after 'safety on time' before 'ETS solenoid hold' when the sensor is selected as temperature sensor and pressure sensor; It is always detected when the sensor is selected as fuel level sensor.
25	Flex. Sensor 1 Low	When over low alarm is enabled, and the controller detects the sensor value is below the preset low limit, it shall issue an alarm signal. It is detected after 'safety on time' before 'ETS solenoid hold' when the sensor is selected as temperature sensor and pressure sensor;



No	Type	Description
		It is always detected when the sensor is selected as fuel level sensor.
26	Flex. Sensor 1 Wrong	When voltage or current input is selected for the curve type of the controller, and the controller detects input signal is abnormal, it shall issue an alarm signal, and meanwhile the curve is transferred to resistor type to prevent damaging the controller. It is detected always.
27	Flex. Sensor 2 Open	When the controller detects the sensor circuit is open, it shall issue an alarm signal. It is always detected.
28	Flex. Sensor 2 High	When over high alarm is enabled, and the controller detects the sensor value is above the preset upper limit, it shall issue an alarm signal. It is detected after 'safety on time' before 'ETS solenoid hold' when the sensor is selected as temperature sensor and pressure sensor; It is always detected when the sensor is selected as fuel level sensor.
29	Flex. Sensor 2 Low	When over low alarm is enabled, and the controller detects the sensor value is below the preset low limit, it shall issue an alarm signal. It is detected after 'safety on time' before 'ETS solenoid hold' when the sensor is selected as temperature sensor and pressure sensor; It is always detected when the sensor is selected as fuel level sensor.
30	Charge Alternator Failure	When this is enabled, and the controller detects the charger voltage value is below the preset limit, it shall issue an alarm signal. It is detected when the genset is normally running.
31	Battery Over Volt	When this is enabled, and the controller detects the battery voltage is above the preset limit, it shall issue an alarm signal. It is always detected.
32	Battery Under Volt	When this is enabled, and the controller detects the battery voltage is below the preset limit, it shall issue an alarm signal. It is always detected.
33	Fail to Sync.	If the controller doesn't detect sync. signal within the pre-set time, it will initiate an alarm signal. It is detected when GCB closes.
34	Volt ASynchrony	After GCB is closed, the voltage difference between busbar and generator is above the preset synchronous voltage, the controller shall issue an alarm signal. It is detected after GCB is closed.
35	Freq ASynchrony	After GCB is closed, the frequency difference between busbar and generator is above the preset synchronous frequency, the controller shall issue an alarm signal. It is detected after GCB is closed.
36	Phase ASynchrony	After GCB is closed, the voltage phase difference between busbar and generator is above the preset synchronous phase, the controller shall issue an alarm signal. It is detected after GCB is closed.





No	Type	Description
37	Gen Close Failure	When the controller detects GCB close fails, that is, after close output the close status input is inactive, it will initiate an alarm signal. It is detected after GCB is closed.
38	Gen Open Failure	When the controller detects GOB open fails, that is, after open output the open status input is inactive, it will initiate an alarm signal. It is detected after GCB is closed.
39	MSC Too Few Sets	When the controller detects the number of the paralleled gensets is smaller than the set minimum paralleled number, it will initiate an alarm signal. There are 2 possible reasons: a) the communication wire between the controllers is detached, leading to communication interrupt. b) the controller of paralleled gen-sets is not powered on. It is always detected.
40	Maintenance Due	When this is enabled and countdown time is 0, it will initiate an alarm signal. It is detected when the genset is running.
41	Digital Input Alarm	When the digital input port is set users-defined and if it is active, the controller will initiate an alarm signal for the input port. It is detected in the detection range set for the input port.
42	PLC Functions Alarm	When PLC function is set users-defined and if it is active, the controller will initiate an alarm signal. It is detected in the detection range set by the PLC function.
43	DIN16 Com. Fail	When DIN16 communication is enabled and the controller cannot receive the communication data, it will initiate an alarm signal. It is always detected.
44	DIN16 Input Alarm	When DIN16 input is set users-defined and if it is active, the controller will initiate an alarm signal. It is detected in the detection range set in the input.
45	DOUT16 Com. Fail	When DOUT16 communication is enabled and the controller cannot receive the communication data, it will initiate an alarm signal. It is always detected.
46	AIN24 Com. Fail	When AIN24 communication is enabled and the controller cannot receive the communication data, it will initiate an alarm signal. It is always detected.
47	AIN24 Cylinder Temp. High	When this is enabled and the controller detects cylinder temperature has exceeded the pre-set value, it will initiate an alarm signal. It is detected after 'safety on time' before 'ETS solenoid hold'.
48	AIN24 Exhaust Temp. High	When this is enabled and the controller detects exhaust temperature has exceeded the pre-set value, it will initiate an alarm signal. It is detected after 'safety on time' before 'ETS solenoid hold'.
49	AIN24 Cylinder Temp. Difference High	When this is enabled and the controller detects cylinder temp. difference has exceeded the pre-set value, it will initiate an alarm signal. It is detected after 'safety on time' before 'ETS solenoid hold'.
50	AIN24 Sensor Open	When the controller detects the sensor circuit is open, it shall issue an



No	Type	Description
		alarm signal. It is always detected.
51	AIN24 Sensor High	When over high alarm is enabled, and the controller detects the sensor value is above the preset upper limit, it shall issue an alarm signal. It is detected after 'safety on time' before 'ETS solenoid hold' when the sensor is selected as temperature sensor and pressure sensor; It is always detected when the sensor is selected as fuel level sensor.
52	AIN24 Sensor Low	When over low alarm is enabled, and the controller detects the sensor value is below the preset lower limit, it shall issue an alarm signal. It is detected after 'safety on time' before 'ETS solenoid hold' when the sensor is selected as temperature sensor and pressure sensor; It is always detected when the sensor is selected as fuel level sensor.
53	Power Factor Low	When this is enabled and the controller detects that the generator power factor has fallen below the pre-set limit, it will initiate an alarm signal. It is always detected.
54	THD High	When this is enabled and the controller detects that the THD has exceeded the pre-set limit, it will initiate an alarm signal. It is always detected.
55	Gen Volt Unbalance	When this is enabled and the controller detects that the voltage unbalanced value has exceeded the pre-set limit, it will initiate an alarm signal. It is always detected.
56	Ground Relay Close Fail	When controller detects that ground relay close fails, that is, breaker close input is inactive after ground relay close outputs, and then it will initiate an alarm signal. It is detected when ground relay is closing.
57	Ground Relay Open Fail	When controller detects that ground relay open fails, that is, breaker open input is inactive after ground relay open outputs, and then it will initiate an alarm signal. It is detected when ground relay is opening.



## 5.7 TRIP AND STOP ALARM

When the controller detects trip and stop signals, it will open breaker directly and stop the genset after cooling. Users need to reset alarms manually.

**Table 13 Trip and Stop Alarms**

No	Type	Description
1	Over Speed	When this is enabled, and the controller detects that the genset speed is above the pre-set limit, it will initiate an alarm signal. It is always detected.
2	Under Speed	When this is enabled and the controller detects that the genset speed is below the pre-set limit, it will initiate an alarm signal. It is detected after 'warming up' and before 'stop idle'.
3	Loss of Speed Signal	When the controller detects the genset speed is 0, it shall issue an alarm signal. It is detected after 'safety on time' and before 'ETS solenoid hold'.
4	Gen Over Frequency	When this is enabled, and the controller detects the genset frequency is above preset limit, it shall issue an alarm signal. It is detected always.
5	Gen Under Frequency	When this is enabled, and the controller detects the frequency is below the preset limit, it shall issue an alarm signal. It is detected after 'warming up' and before 'stop idle'.
6	Gen Over Voltage	When this is enabled, and the controller detects the genset voltage is above preset limit, it shall issue an alarm signal. It is detected always.
7	Genset Under Voltage	When this is enabled, and the controller detects the voltage is below the preset limit, it shall issue an alarm signal. It is detected after 'warming up' and before 'stop idle'.
8	Gen Over Current	When this is enabled, and the controller detects the genset current is above preset limit, it shall issue an alarm signal. It is detected always.
9	Negative Sequence Current	When this is enabled, and the controller detects the unbalanced current is above preset limit, it shall issue an alarm signal. It is detected always.
10	Earth Fault	When this is enabled, and the controller detects the earth current is above the preset limit, it shall issue an alarm signal. It is always detected.
11	Reverse Power	When this is enabled, and the controller detects the reverse power (negative) is above the preset limit, it shall issue an alarm signal. It is always detected.
12	Over Power	When this is enabled, and the controller detects the genset power (positive) is above the preset limit, it shall issue an alarm signal. It is always detected.
13	Loss Excitation	When this is enabled, and the controller detects the genset reactive



No	Type	Description
		power (negative) is above the preset limit, it shall issue an alarm signal. It is always detected.
14	ECU Alarm	When the controller receives the engine alarm signal from J1939, it shall issue an alarm signal. It is always detected.
15	Temp. Sensor Open	When the controller detects the sensor circuit is open, it shall issue an alarm signal. It is always detected.
16	Engine Temp High	When this is enabled, and the controller detects the temp. is above the preset limit, it shall issue an alarm signal. It is detected after 'safety on time' before 'ETS solenoid hold'.
17	Engine Temp Low	When this is enabled, and the controller detects the temp. is below the preset limit, it shall issue an alarm signal. It is detected after 'safety on time' before 'ETS solenoid hold'.
18	Oil Pressure Sensor Open	When the controller detects the sensor circuit is open, it shall issue an alarm signal. It is always detected.
19	Oil Pressure Low	When this is enabled, and the controller detects the pressure is below the preset limit, it shall issue an alarm signal. It is detected after 'safety on time' before 'ETS solenoid hold'.
20	Oil Pressure Sensor Wrong	When voltage or current input is selected for the curve type of the controller, and the controller detects input signal is abnormal, it shall issue an alarm signal, and meanwhile the curve is transferred to resistor type to prevent damaging the controller. It is detected always.
21	Fuel Level Sensor Open	When the controller detects the sensor circuit is open, it shall issue an alarm signal. It is always detected.
22	Fuel Level Low	When this is enabled, and the controller detects the level is below the preset limit, it shall issue an alarm signal. It is always detected.
23	Flex. Sensor 1 Open	When the controller detects the sensor circuit is open, it shall issue an alarm signal. It is always detected.
24	Flex. Sensor 1 High	When over high alarm is enabled, and the controller detects the sensor value is above the preset upper limit, it shall issue an alarm signal. It is detected after 'safety on time' before 'ETS solenoid hold' when the sensor is selected as temperature sensor and pressure sensor; It is always detected when the sensor is selected as fuel level sensor.
25	Flex. Sensor 1 Low	When over low alarm is enabled, and the controller detects the sensor value is below the preset low limit, it shall issue an alarm signal. It is detected after 'safety on time' before 'ETS solenoid hold' when the sensor is selected as temperature sensor and pressure sensor;



No	Type	Description
		It is always detected when the sensor is selected as fuel level sensor.
26	Flex. Sensor 1 Wrong	When voltage or current input is selected for the curve type of the controller, and the controller detects input signal is abnormal, it shall issue an alarm signal, and meanwhile the curve is transferred to resistor type to prevent damaging the controller. It is detected always.
27	Flex. Sensor 2 Open	When the controller detects the sensor circuit is open, it shall issue an alarm signal. It is always detected.
28	Flex. Sensor 2 High	When over high alarm is enabled, and the controller detects the sensor value is above the preset upper limit, it shall issue an alarm signal. It is detected after 'safety on time' before 'ETS solenoid hold' when the sensor is selected as temperature sensor and pressure sensor; It is always detected when the sensor is selected as fuel level sensor.
29	Flex. Sensor 2 Low	When over low alarm is enabled, and the controller detects the sensor value is below the preset low limit, it shall issue an alarm signal. It is detected after 'safety on time' before 'ETS solenoid hold' when the sensor is selected as temperature sensor and pressure sensor; It is always detected when the sensor is selected as fuel level sensor.
30	Charge Alternator Failure	When this is enabled, and the controller detects the charger voltage value is below the preset limit, it shall issue an alarm signal. It is detected when the genset is normally running.
31	Battery Over Volt	When this is enabled, and the controller detects the battery voltage is above the preset limit, it shall issue an alarm signal. It is always detected.
32	Battery Under Volt	When this is enabled, and the controller detects the battery voltage is below the preset limit, it shall issue an alarm signal. It is always detected.
33	Fail to Sync.	If the controller doesn't detect sync. signal within the pre-set time, it will initiate an alarm signal. It is detected when GCB closes.
34	Mains Over Freq	When the controller detects mains frequency is above the set limit, it shall issue an alarm signal. It is detected after mains parallel mode is active and GCB is closed.
35	Mains Under Freq	When the controller detects mains frequency is below the set limit, it shall issue an alarm signal. It is detected after mains parallel mode is active and GCB is closed.
36	Mains Over Voltage	When the controller detects mains voltage is above the set limit, it shall issue an alarm signal. It is detected after mains parallel mode is active and GCB is closed.
37	Mains Under Voltage	When the controller detects mains voltage is below the set limit, it shall issue an alarm signal. It is detected after mains parallel mode is active and GCB is closed.



No	Type	Description
38	Mains ROCOF	When the controller detects mains ROCOF is above the set limit, it shall issue an alarm signal. It is detected after mains parallel mode is active and GCB is closed.
39	Mains Vector Shift	When the controller detects mains voltage vector change is above the set limit, it shall issue an alarm signal. It is detected after mains parallel mode is active and GCB is closed.
40	MSC Too Few Sets	When the controller detects the number of the paralleled gensets is smaller than the set minimum paralleled number, it will initiate an alarm signal. There are 2 possible reasons: a) the communication wire between the controllers is detached, leading to communication interrupt. b) the controller of paralleled gen-sets is not powered on. It is always detected.
41	Maintenance Due	When this is enabled and countdown time is 0, it will initiate an alarm signal. It is detected when the genset is running.
42	Digital Input Alarm	When the digital input port is set users-defined and if it is active, the controller will initiate an alarm signal for the input port. It is detected in the detection range set for the input port.
43	PLC Functions Alarm	When PLC function is set users-defined and if it is active, the controller will initiate an alarm signal. It is detected in the detection range set by the PLC function.
44	DIN16 Com. Fail	When DIN16 communication is enabled and the controller cannot receive the communication data, it will initiate an alarm signal. It is always detected.
45	DIN16 Input Alarm	When DIN16 input is set users-defined and if it is active, the controller will initiate an alarm signal. It is detected in the detection range set in the input.
46	DOUT16 Com. Fail	When DOUT16 communication is enabled and the controller cannot receive the communication data, it will initiate an alarm signal. It is always detected.
47	AIN24 Com. Fail	When AIN24 communication is enabled and the controller cannot receive the communication data, it will initiate an alarm signal. It is always detected.
48	AIN24 Cylinder Temp. High	When this is enabled and the controller detects cylinder temperature has exceeded the pre-set value, it will initiate an alarm signal. It is detected after 'safety on time' before 'ETS solenoid hold'.
49	AIN24 Exhaust Temp. High	When this is enabled and the controller detects exhaust temperature has exceeded the pre-set value, it will initiate an alarm signal. It is detected after 'safety on time' before 'ETS solenoid hold'.
50	AIN24 Cylinder Temp. Difference High	When this is enabled and the controller detects cylinder temp. difference has exceeded the pre-set value, it will initiate an alarm signal. It is detected after 'safety on time' before 'ETS solenoid hold'.
51	AIN24 Sensor Open	When the controller detects the sensor circuit is open, it shall issue an



No	Type	Description
		alarm signal. It is always detected.
52	AIN24 Sensor High	When over high alarm is enabled, and the controller detects the sensor value is above the preset upper limit, it shall issue an alarm signal. It is detected after 'safety on time' before 'ETS solenoid hold' when the sensor is selected as temperature sensor and pressure sensor; It is always detected when the sensor is selected as fuel level sensor.
53	AIN24 Sensor Low	When over low alarm is enabled, and the controller detects the sensor value is below the preset lower limit, it shall issue an alarm signal. It is detected after 'safety on time' before 'ETS solenoid hold' when the sensor is selected as temperature sensor and pressure sensor; It is always detected when the sensor is selected as fuel level sensor.
54	Power Factor Low	When this is enabled and the controller detects that the generator power factor has fallen below the pre-set limit, it will initiate an alarm signal. It is always detected.
55	THD High	When this is enabled and the controller detects that the THD has exceeded the pre-set limit, it will initiate an alarm signal. It is always detected.
56	Gen Volt Unbalance	When this is enabled and the controller detects that the voltage unbalanced value has exceeded the pre-set limit, it will initiate an alarm signal. It is always detected.
57	MSC Mains Decoupling	When the controller receives 'MSC Mains Decoupling' alarm, it shall issue an alarm signal. It is always detected.
58	Ground Relay Close Fail	When the controller detects that ground relay close fails, that is, breaker close input is inactive after ground relay close outputs, and then it will initiate an alarm signal. It is detected when ground relay is closing.
59	Ground Relay Open Fail	When controller detects that ground relay open fails, that is, breaker open input is inactive after ground relay open outputs, and then it will initiate an alarm signal. It is detected when ground relay is opening.
60	Static Parallel Fail	After the controller starts the genset, if it doesn't reach the load speed in the preset delay, the controller shall issue an alarm signal. It is detected when Static Parallel mode is active.



## 5.8 SHUTDOWN ALARMS

When controller detects shutdown alarms, it will send signal to open breaker and shut down the generator. Users need to reset alarms manually.

**Table 14 Shutdown Alarms**

No	Type	Description
1	Emergency Stop	When the controller detects emergency stop signals, it will initiate a shutdown alarm. It is always detected.
2	Over Speed	When this is enabled, and the controller detects that the genset speed is above the pre-set limit, it will initiate an alarm signal. It is always detected.
3	Under Speed	When this is enabled and the controller detects that the genset speed is below the pre-set limit, it will initiate an alarm signal. It is detected after 'warming up' and before 'stop idle'.
4	Loss of Speed Signal	When the controller detects the genset speed is 0, it shall issue an alarm signal. It is detected after 'safety on time' and before 'ETS solenoid hold'.
5	Gen Over Frequency	When this is enabled, and the controller detects the genset frequency is above preset limit, it shall issue an alarm signal. It is detected always.
6	Gen Under Frequency	When this is enabled, and the controller detects the frequency is below the preset limit, it shall issue an alarm signal. It is detected after 'warming up' and before 'stop idle'.
7	Gen Over Voltage	When this is enabled, and the controller detects the genset voltage is above preset limit, it shall issue an alarm signal. It is detected always.
8	Genset Under Voltage	When this is enabled, and the controller detects the voltage is below the preset limit, it shall issue an alarm signal. It is detected after 'warming up' and before 'stop idle'.
9	Fail to Start	If the genset doesn't start during the start attempts, the controller shall issue an alarm signal.
10	Gen Over Current	When this is enabled, and the controller detects the genset current is above preset limit, it shall issue an alarm signal. It is detected always.
11	Negative Sequence Current	When this is enabled, and the controller detects the unbalanced current is above preset limit, it shall issue an alarm signal. It is detected always.
12	Earth Fault	When this is enabled, and the controller detects the earth current is above the preset limit, it shall issue an alarm signal. It is always detected.
13	Reverse Power	When this is enabled, and the controller detects the reverse power (negative) is above the preset limit, it shall issue an alarm signal.





No	Type	Description
		It is always detected.
14	Over Power	When this is enabled, and the controller detects the genset power (positive) is above the preset limit, it shall issue an alarm signal. It is always detected.
15	Loss Excitation	When this is enabled, and the controller detects the genset reactive power (negative) is above the preset limit, it shall issue an alarm signal. It is always detected.
16	ECU Com. Fail	When the controller doesn't receive the engine alarm signal from J1939, it shall issue an alarm signal. It is always detected.
17	ECU Alarm	When the controller receives the engine alarm signal from J1939, it shall issue an alarm signal. It is always detected.
18	Aux High Temp Alarm	When the controller detects that this alarm in the input port is active, it shall issue an alarm signal. It is detected after 'safety on time' and before 'ETS solenoid hold'.
19	Aux Low OP Alarm	When the controller detects that this alarm in the input port is active, it shall issue an alarm signal. It is detected after 'safety on time' and before 'ETS solenoid hold'.
20	MSC ID Error	When the controller detects MSC bus has the same IDs, it shall issue shutdown alarm signal. It is always detected.
21	Volt Bus Error	When the controller detects other genset GCBs are closed, but busbar voltage is below the uncharged busbar voltage, it shall issue an alarm signal. It is detected when GCB is closed.
22	Gen Phase Seq Wrong	When the controller detects phase sequence error, it shall issue an alarm signal. It is always detected.
23	Bus Phase Seq Wrong	When the controller detects busbar sequence error, it shall issue an alarm signal. It is detected always.
24	Temp. Sensor Open	When the controller detects the sensor circuit is open, it shall issue an alarm signal. It is always detected.
25	Engine Temp High	When this is enabled, and the controller detects the temp. is above the preset limit, it shall issue an alarm signal. It is detected after 'safety on time' before 'ETS solenoid hold'.
26	Engine Temp Low	When this is enabled, and the controller detects the temp. is below the preset limit, it shall issue an alarm signal. It is detected after 'safety on time' before 'ETS solenoid hold'.
27	Oil Pressure Sensor Open	When the controller detects the sensor circuit is open, it shall issue an alarm signal.



No	Type	Description
		It is always detected.
28	Oil Pressure Low	When this is enabled, and the controller detects the pressure is below the preset limit, it shall issue an alarm signal. It is detected after 'safety on time' before 'ETS solenoid hold'.
29	Oil Pressure Sensor Wrong	When voltage or current input is selected for the curve type of the controller, and the controller detects input signal is abnormal, it shall issue an alarm signal, and meanwhile the curve is transferred to resistor type to prevent damaging the controller. It is detected always.
30	Fuel Level Sensor Open	When the controller detects the sensor circuit is open, it shall issue an alarm signal. It is always detected.
31	Fuel Level Low	When this is enabled, and the controller detects the level is below the preset limit, it shall issue an alarm signal. It is always detected.
32	Flex. Sensor 1 Open	When the controller detects the sensor circuit is open, it shall issue an alarm signal. It is always detected.
33	Flex. Sensor 1 High	When over high alarm is enabled, and the controller detects the sensor value is above the preset upper limit, it shall issue an alarm signal. It is detected after 'safety on time' before 'ETS solenoid hold' when the sensor is selected as temperature sensor and pressure sensor; It is always detected when the sensor is selected as fuel level sensor.
34	Flex. Sensor 1 Low	When over low alarm is enabled, and the controller detects the sensor value is below the preset low limit, it shall issue an alarm signal. It is detected after 'safety on time' before 'ETS solenoid hold' when the sensor is selected as temperature sensor and pressure sensor; It is always detected when the sensor is selected as fuel level sensor.
35	Flex. Sensor 1 Wrong	When voltage or current input is selected for the curve type of the controller, and the controller detects input signal is abnormal, it shall issue an alarm signal, and meanwhile the curve is transferred to resistor type to prevent damaging the controller. It is detected always.
36	Flex. Sensor 2 Open	When the controller detects the sensor circuit is open, it shall issue an alarm signal. It is always detected.
37	Flex. Sensor 2 High	When over high alarm is enabled, and the controller detects the sensor value is above the preset upper limit, it shall issue an alarm signal. It is detected after 'safety on time' before 'ETS solenoid hold' when the sensor is selected as temperature sensor and pressure sensor; It is always detected when the sensor is selected as fuel level sensor.
38	Flex. Sensor 2 Low	When over low alarm is enabled, and the controller detects the sensor value is below the preset low limit, it shall issue an alarm signal.



No	Type	Description
		It is detected after 'safety on time' before 'ETS solenoid hold' when the sensor is selected as temperature sensor and pressure sensor; It is always detected when the sensor is selected as fuel level sensor.
39	Charge Alternator Failure	When this is enabled, and the controller detects the charger voltage value is below the preset limit, it shall issue an alarm signal. It is detected when the genset is normally running.
40	Battery Over Volt	When this is enabled, and the controller detects the battery voltage is above the preset limit, it shall issue an alarm signal. It is always detected.
41	Battery Under Volt	When this is enabled, and the controller detects the battery voltage is below the preset limit, it shall issue an alarm signal. It is always detected.
42	Fail to Sync.	If the controller doesn't detect sync. signal within the pre-set time, it will initiate an alarm signal. It is detected when GCB closes.
43	MSC Too Few Sets	When the controller detects the number of the paralleled gensets is smaller than the set minimum paralleled number, it will initiate an alarm signal. There are 2 possible reasons: a) the communication wire between the controllers is detached, leading to communication interrupt. b) the controller of paralleled gen-sets is not powered on. It is always detected.
44	Maintenance Due	When this is enabled and countdown time is 0, it will initiate an alarm signal. It is detected when the genset is running.
45	Low Coolant Level	When the controller detects Low Coolant Level in the input port is active, it shall issue an alarm signal. It is always detected.
46	Detonation Alarm	When the controller detects Detonation Alarm in the input port is active, it shall issue an alarm signal. It is always detected.
47	Gas Leak Alarm	When the controller detects Gas Leak Alarm in the input port is active, it shall issue an alarm signal. It is always detected.
48	Digital Input Alarm	When the digital input port is set users-defined and if it is active, the controller will initiate an alarm signal for the input port. It is detected in the detection range set for the input port.
49	PLC Functions Alarm	When PLC function is set users-defined and if it is active, the controller will initiate an alarm signal. It is detected in the detection range set by the PLC function.
50	DIN16 Com. Fail	When DIN16 communication is enabled and the controller cannot receive the communication data, it will initiate an alarm signal. It is always detected.
51	DIN16 Input Alarm	When DIN16 input is set users-defined and if it is active, the controller



No	Type	Description
		will initiate an alarm signal. It is detected in the detection range set in the input.
52	DOUT16 Com. Fail	When DOUT16 communication is enabled and the controller cannot receive the communication data, it will initiate an alarm signal. It is always detected.
53	AIN24 Com. Fail	When AIN24 communication is enabled and the controller cannot receive the communication data, it will initiate an alarm signal. It is always detected.
54	AIN24 Cylinder Temp. High	When this is enabled and the controller detects cylinder temperature has exceeded the pre-set value, it will initiate an alarm signal. It is detected after 'safety on time' before 'ETS solenoid hold'.
55	AIN24 Exhaust Temp. High	When this is enabled and the controller detects exhaust temperature has exceeded the pre-set value, it will initiate an alarm signal. It is detected after 'safety on time' before 'ETS solenoid hold'.
56	AIN24 Cylinder Temp. Difference High	When this is enabled and the controller detects cylinder temp. difference has exceeded the pre-set value, it will initiate an alarm signal. It is detected after 'safety on time' before 'ETS solenoid hold'.
57	AIN24 Sensor Open	When the controller detects the sensor circuit is open, it shall issue an alarm signal. It is always detected.
58	AIN24 Sensor High	When over high alarm is enabled, and the controller detects the sensor value is above the preset upper limit, it shall issue an alarm signal. It is detected after 'safety on time' before 'ETS solenoid hold' when the sensor is selected as temperature sensor and pressure sensor; It is always detected when the sensor is selected as fuel level sensor.
59	AIN24 Sensor Low	When over low alarm is enabled, and the controller detects the sensor value is below the preset lower limit, it shall issue an alarm signal. It is detected after 'safety on time' before 'ETS solenoid hold' when the sensor is selected as temperature sensor and pressure sensor; It is always detected when the sensor is selected as fuel level sensor.
60	Power Factor Low	When this is enabled and the controller detects that the generator power factor has fallen below the pre-set limit, it will initiate an alarm signal. It is always detected.
61	THD High	When this is enabled and the controller detects that the THD has exceeded the pre-set limit, it will initiate an alarm signal. It is always detected.
62	Gen Volt Unbalance	When this is enabled and the controller detects that the voltage unbalanced value has exceeded the pre-set limit, it will initiate an alarm signal. It is always detected.
63	Ground Relay Close Fail	When the controller detects that ground relay close fails, that is, breaker close input is inactive after ground relay close outputs, and then it will initiate an alarm signal.



No	Type	Description
		It is detected when ground relay is closing.
64	Ground Relay Open Fail	When controller detects that ground relay open fails, that is, breaker open input is inactive after ground relay open outputs, and then it will initiate an alarm signal. It is detected when ground relay is opening.

### 6 WIRING CONNECTION

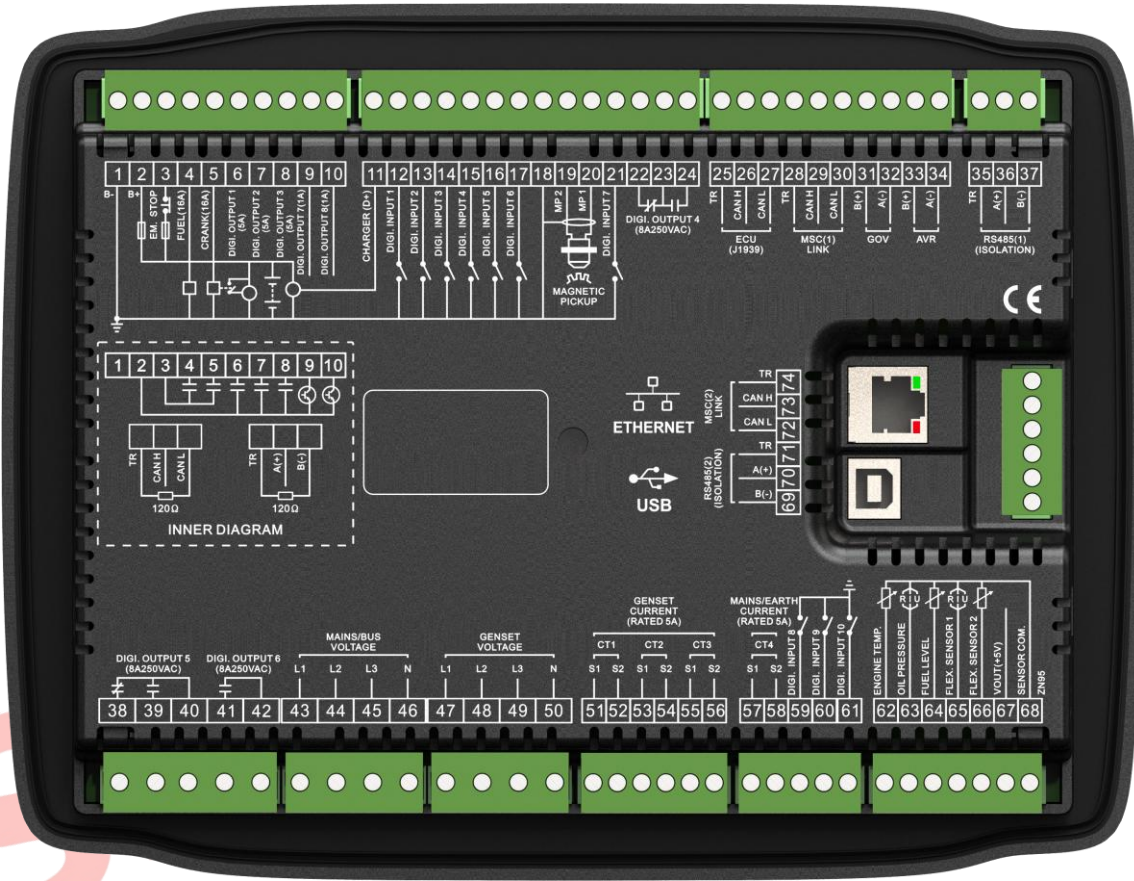

Fig. 3 HGM9530N Controller Rear Panel Drawing

Table 15 Terminal Connection Description

No.	Functions	Cable Size	Remark
1	B-	2.5mm <sup>2</sup>	Connect with starter battery negative.
2	B+	2.5mm <sup>2</sup>	Connect with starter battery positive. If wire length is over 30m, it's better to double wires in parallel. Max. 20A fuse is recommended.
3	Emergency stop	2.5mm <sup>2</sup>	Connect with B+ via emergency stop button.
4	Fuel relay	1.5mm <sup>2</sup>	B+ is supplied by 3 points, rated 16A.
5	Crank relay	1.5mm <sup>2</sup>	B+ is supplied by 3 points, rated 16A. Connect to starter coil.
6	Digi. output 1	1.5mm <sup>2</sup>	B+ is supplied by 2 points, rated 5A.



No.	Functions	Cable Size	Remark
7	Digi. output 2	1.5mm <sup>2</sup>	B+ is supplied by 2 points, rated 5A.
8	Digi. output 3	1.5mm <sup>2</sup>	B+ is supplied by 2 points, rated 5A.
9	Digi. output 7	1.5mm <sup>2</sup>	B+ is supplied by 2 points, rated 1A.
10	Digi. output 8	1.5mm <sup>2</sup>	B+ is supplied by 2 points, rated 1A.
11	Charger (D+)	1.0mm <sup>2</sup>	Connect with Charger D+ (WL) terminal. If this terminal doesn't exist, hang it in the air.
12	Digi. input 1	1.0mm <sup>2</sup>	Ground connected is active (B-).
13	Digi. input 2	1.0mm <sup>2</sup>	Ground connected is active (B-).
14	Digi. input 3	1.0mm <sup>2</sup>	Ground connected is active (B-).
15	Digi. input 4	1.0mm <sup>2</sup>	Ground connected is active (B-).
16	Digi. input 5	1.0mm <sup>2</sup>	Ground connected is active (B-).
17	Digi. input 6	1.0mm <sup>2</sup>	Ground connected is active (B-).
18	Magnetic pickup shield	0.5mm <sup>2</sup>	Connect with speed sensor, and shielding line is recommended. B- is already connected with speed sensor input 2 in the inside controller.
19	MP2		
20	MP1		
21	Digi. input 7	1.0mm <sup>2</sup>	Ground connected is active (B-).
22	Digi. output 4	1.5mm <sup>2</sup>	Normally close output, rated 8A.
23			Public points of relay.
24			Normally open output, rated 8A.
25	ECU TR	/	Impedance-120Ω shielding wire is recommended, and the single-end shall be earth connected. Short connect TR with H and then connect to 120Ω terminal resistor.
26	ECU CAN H	0.5mm <sup>2</sup>	
27	ECU CAN L	0.5mm <sup>2</sup>	
28	MSC(1) TR	/	Impedance-120Ω shielding wire is recommended, and the single-end shall be earth connected. Short connect TR with H and then connect to 120Ω terminal resistor.
29	MSC(1) CAN H	0.5mm <sup>2</sup>	
30	MSC(1) CAN L	0.5mm <sup>2</sup>	
31	GOV B(+)	0.5mm <sup>2</sup>	Shielding wire is recommended. Shielding layer shall be earth connected at GOV end.
32	GOV A(-)	0.5mm <sup>2</sup>	
33	AVR B(+)	0.5mm <sup>2</sup>	Shielding wire is recommended. Shielding layer shall be earth connected at AVR end.
34	AVR A(-)	0.5mm <sup>2</sup>	
35	RS485(1) TR	/	Impedance-120Ω shielding wire is recommended, and the single-end shall be earth connected. Short connect TR with H and then connect to 120Ω terminal resistor.
36	RS485(1) A(+)	0.5mm <sup>2</sup>	
37	RS485(1) B(-)	0.5mm <sup>2</sup>	
38	Digi. output 5	2.5mm <sup>2</sup>	Normally close output, rated 8A.
39		2.5mm <sup>2</sup>	Normally open output, rated 8A.
40		2.5mm <sup>2</sup>	Public points of relay.
41	Digi. output 6	2.5mm <sup>2</sup>	Normally open output, rated 8A.
42		2.5mm <sup>2</sup>	Public points of relay.
43	Bus A-phase voltage input	1.0mm <sup>2</sup>	Connect to A-phase of bus (2A fuse is recommended).
44	Bus B-phase voltage input	1.0mm <sup>2</sup>	Connect to B-phase of bus (2A fuse is recommended).



No.	Functions	Cable Size	Remark
45	Bus C-phase voltage input	1.0mm <sup>2</sup>	Connect to C-phase of bus (2A fuse is recommended).
46	Bus N-wire input	1.0mm <sup>2</sup>	Connect to N-wire of bus.
47	Genset A-phase voltage input	1.0mm <sup>2</sup>	Connect to A-phase of gen-set (2A fuse is recommended).
48	Genset B-phase voltage input	1.0mm <sup>2</sup>	Connect to B-phase of gen-set (2A fuse is recommended).
49	Genset C-phase voltage input	1.0mm <sup>2</sup>	Connect to C-phase of gen-set (2A fuse is recommended).
50	Genset N-wire input	1.0mm <sup>2</sup>	Connect to N-wire of genset.
51	CT A-phase input	1.5mm <sup>2</sup>	Outside connect to secondary coil of current transformer (rated 5A).
52		1.5mm <sup>2</sup>	
53	CT B-phase input	1.5mm <sup>2</sup>	Outside connect to secondary coil of current transformer (rated 5A).
54		1.5mm <sup>2</sup>	
55	CT C-phase input	1.5mm <sup>2</sup>	Outside connect to secondary coil of current transformer (rated 5A).
56		1.5mm <sup>2</sup>	
57	Earth CT input	1.5mm <sup>2</sup>	Outside connect to secondary coil of current transformer (rated 5A).
58		1.5mm <sup>2</sup>	
59	Digi. input 8	1.0mm <sup>2</sup>	Ground connected is active (B-).
60	Digi. input 9	1.0mm <sup>2</sup>	Ground connected is active (B-).
61	Digi. input 10	1.0mm <sup>2</sup>	Ground connected is active (B-).
62	Engine Temperature	1.0mm <sup>2</sup>	Connect to temperature resistance sensor.
63	Oil pressure	1.0mm <sup>2</sup>	Connect to engine oil pressure sensor. Voltage type (0V-5V), current type (4mA-20mA) and resistance sensor can be chosen.
64	Fuel level	1.0mm <sup>2</sup>	Connect to fuel level resistance sensor.
65	Flex. sensor 1	1.0mm <sup>2</sup>	Connect to temp. /fuel level/pressure type sensor. Voltage type (0V-5V), current type (4mA-20mA) and resistance sensor can be chosen.
66	Flex. sensor 2	1.0mm <sup>2</sup>	Connect to temp. /fuel level/pressure type sensor.
67	VOUT(+5V)	1.0mm <sup>2</sup>	Provide +5V voltage for voltage type sensor, and current is below 50mA.
68	Sensor COM.	/	Public sensor terminal, and B- is already connected in the controller.
69	RS485(2) B(-)	0.5mm <sup>2</sup>	Impedance-120Ω shielding wire is recommended, and the single-end shall be earth connected. Short connect TR with H and then connect to 120Ω terminal resistor.
70	RS485(2) A(+)	0.5mm <sup>2</sup>	
71	RS485(2) TR	/	Impedance-120Ω shielding wire is recommended, and the single-end shall be earth connected. Short connect TR with H and then connect to 120Ω terminal resistor. (Not available for HGM9510N)
72	MSC(2) CAN L	/	
73	MSC(2) CAN H	0.5mm <sup>2</sup>	Impedance-120Ω shielding wire is recommended, and the single-end shall be earth connected. Short connect TR with H and then connect to 120Ω terminal resistor. (Not available for HGM9510N)
74	MSC(2) TR	0.5mm <sup>2</sup>	



**NOTE:** USB ports on the controller rear panel are configurable parameter ports, and users can directly program the controller on PC.

**NOTE:** ETHERNET port on the controller rear panel is parameter programming and monitoring port, and it can be programmed and monitored on PC.

## 7 SCOPES AND DEFINITIONS OF PROGRAMMABLE PARAMETERS

### 7.1 CONTENTS AND SCOPES OF PARAMETERS

**Table 16 Parameter Configuration**

No.	Items	Parameters	Defaults	Description
<b>Module Setting</b>				
1.	Power On Mode	(0-2)	0	0: Stop Mode 1: Manual Mode 2: Auto Mode
2.	Communication Address	(1-254)	1	Controller address for remote monitoring
3.	Communication Stop Bit	(0-1)	0	0: 2-Bit Stop Bit 1: 1-Bit Stop Bit This cannot be set on the front panel.
4.	Language	(0-2)	0	0: Simplified Chinese 1: English 2: Other
5.	Password	(0-65535)	00318	It is used to enter advanced parameter setting.
6.	Daylight Saving Time	(0-1)	0	0: Disable 1: Enable Start and end time for this can be set.
7.	Date and Time			It is used for date and time settings.
8.	Temperature Unit	(0-1)	0	0: °C; 1: °F
9.	Pressure Unit	(0-2)	0	0: kPa 1: Psi 2: Bar
10.	Backlight Time	(0-3600)s	300	
11.	Non-parallel Mode	(0-1)	0	0: Disable 1: Enable
12.	Network	(0-1)	1	0: Disable 1: Enable
13.	J1939-75	(0-1)	0	0: Disable 1: Enable
14.	Alarm Data Interval	(0-60.0)s	0.1	





No.	Items	Parameters	Defaults	Description
15.	MSC2	(0-1)	0	0: Disable 1: Enable When it is enabled, MSC1 works with MSC2 in parallel. (Not available for HGM9510N)
16.	Mains/Redundant	(0-2)	0	0: Sole Module 1: Main Module 2: Redundant Module (Not available for HGM9510N)
17.	Fn Function	(0-6)	0	0: Fn Button 1: Stop Button 2: Start Button 3: Manual Button 4: Auto Button 5: Close Button 6: Open Button
<b>Timer Setting</b>				
1.	Start Delay	(0~3600)s	5	Time from mains abnormal or remote start signal is active to genset is starting.
2.	Stop Delay	(0~3600)s	30	Time from mains abnormal or remote start signal is active to genset is stopping.
3.	Preheat Delay	(0~3600)s	0	Time for pre-powering the heat plug before starter is powered up.
4.	Cranking Time	(3~60)s	8	Time for starter power on each time.
5.	Crank Rest Time	(3~60)s	10	The waiting time before second power up when engine start fails.
6.	Safety On Delay	(0-3600)s	10	Alarms for low oil pressure, high temperature, under speed, under frequency /voltage, charge fail are inactive.
7.	Start Idle Time	(0~3600)s	10	Running time for genset idling speed when the genset is starting.
8.	Warming Up Time	(0~3600)s	30	Warming up time between genset switch on and high speed running.
9.	Cooling Time	(0~3600)s	60	Radiating time before genset stop, after it unloads.
10.	Stop Idle Time	(0~3600)s	10	Running time for genset idling speed when the genset is stopping.
11.	ETS Solenoid Hold	(0~3600)s	20	Time for the stop electromagnet energization as the genset is stopping.
12.	Fail to Stop Delay	(0~3600)s	0	Time after 'idle delay' is over before the complete stop when 'ETS Solenoid Hold' is set "0"; time after 'ETS Solenoid Hold' delay is over before the complete stop when it is



No.	Items	Parameters	Defaults	Description
				set other than "0".
13.	After Stop Time	(0~3600)s	0	Time between a complete stop and standby.
14.	Gas Engine Timers	(0-1)	0	0: Disable 1: Enable When gas engine timer is enabled, fuel oil output is used for controlling gas valve.
15.	Choke On Time	(0-60)s	0	Output time for gas thickening after the engine starts.
16.	Gas On Delay	(0-60)s	0	After this period, gas valve control outputs after the engine starts.
17.	Ignition Off Delay	(0-60)s	0	After this period, gas ignition control stops outputting after the gas valve is closed.
18.	Smart Pre-heat	(0-1)	0	0: Disable 1: Enable When it is enabled, the controller will stop pre-heating earlier according to the setting conditions. Sensors are available, and when it is above the set value, it shall end the pre-heating.
19.	Smart Start Idle	(0-1)	0	0: Disable 1: Enable When it is enabled, the controller will stop pre-heating earlier according to the setting conditions. Sensor is available, and when it is above the set value, it shall end the pre-heating.
<b>Engine Setting</b>				
1.	Engine Type	(0~39)	0	Default: conventional engine(not ECU) When the controller is connected to J1939 engine, choose the corresponding type.
2.	Flywheel Teeth	(10~300)	118	Tooth number of the engine, for judging of starter separation conditions and inspecting of engine speed. See the installation instructions.
3.	Rated Speed	(0~6000)r/min	1500	Offer standard to judge over/under/loading speed.
4.	Loading Speed	(0~100.0)%	90.0	Set value is percentage of rated speed. Controller detects when it is ready to load. It won't switch on when speed is under loading speed.
5.	Loss of Speed Signal	(0~3600)s	5	Time from detecting, 0 speed to action confirm.
6.	Loss of Speed	(0~7)	7	0: None; 1: Warning; 2: Block; 3: Safety



No.	Items	Parameters	Defaults	Description
	Signal Action			Trip; 4: Safety Stop; 5: Trip; 6: Trip and Stop; 7: Shutdown.
7.	Over Speed 1 Set	(0-1) (0-200.0)% (0-200.0)% (0-3600)s (0-7)	1 114.0 112.0 2 7	0: Disable 1: Enable Setting value is rated speed percentage. Return value is rated speed percentage. Delay value Action
8.	Over Speed 2 Sett	(0-1) (0-200.0)% (0-200.0)% (0-3600)s (0-7)	1 110.0 108.0 5 1	0: Disable 1: Enable Setting value is rated speed percentage. Return value is rated speed percentage. Delay value Action
9.	Under Speed 1 Set	(0-1) (0-200.0)% (0-200.0)% (0-3600)s (0-7)	1 80.0 82.0 3 7	0: Disable 1: Enable Setting value is rated speed percentage. Return value is rated speed percentage. Delay value Action
10.	Under Speed 2 Set	(0-1) (0-200.0)% (0-200.0)% (0-3600)s (0-7)	1 86.0 90.0 5 1	0: Disable 1: Enable Setting value is rated speed percentage. Return value is rated speed percentage. Delay value Action
11.	Battery Rated Voltage	(0~60.0)V	24.0	Standard for detecting of over/under voltage of battery.
12.	Battery Over Volt 1	(0-1) (0-200.0)% (0-200.0)% (0-3600)s (0-7)	1 120.0 115.0 60 1	0: Disable 1: Enable Set value is batt. rated volt percentage. Return value is batt. rated volt percentage. Delay value Action
13.	Battery Over Volt 2	(0-1) (0-200.0)% (0-200.0)% (0-3600)s (0-7)	0 120.0 115.0 60 0	0: Disable 1: Enable Set value is batt. rated volt percentage. Return value is batt. rated volt percentage. Delay value Action
14.	Battery Under Volt 1	(0-1) (0-200.0)% (0-200.0)% (0-3600)s (0-7)	1 85.0 90.0 60 1	0: Disable 1: Enable Set value is batt. rated volt percentage. Return value is batt. rated volt percentage. Delay value Action
15.	Battery Under Volt 2	(0-1) (0-200.0)% (0-200.0)% (0-3600)s	0 85.0 90.0 60	0: Disable 1: Enable Set value is batt. rated volt percentage. Return value is batt. rated volt percentage. Delay value



No.	Items	Parameters	Defaults	Description
		(0-7)	0	Action
16.	Charge Alt Fail	(0-1) (0-60.0)V (0-60.0)V (0-3600)s (0-7)	1 8.0 10.0 10 1	0: Disable 1: Enable Setting value Return value Delay value Action
17.	Start Attempts	(1~10) times	3	Maximum crank times for start failures; when it reaches this, controller will send start failure signal.
18.	Crank Disconnect	(0~6)	2	There are 3 conditions of disconnecting starter with engine. Each condition can be used alone and simultaneously to separate the start motor and engine as soon as possible.
19.	Disconnect Generator Freq	(0~200.0)%	24.0	Percentage of the generating rated frequency; when generator frequency is higher than the set value, starter will be disconnected. See the below installation instruction.
20.	Disconnect Engine Speed	(0~200.0)%	24.0	Percentage of the rated speed; when generator speed is higher than the set value, starter will be disconnected. See the installation instruction.
21.	Disconnect Oil Pressure	(0~1000)kPa	200	When generator oil pressure is higher than the set value, starter will be disconnected. See the installation instruction.
22.	ECU Malfunc. Lamp	(0-7)	1	0: None; 1: Warning; 2: Block; 3: Safety Trip; 4: Safety Stop; 5: Trip; 6: Trip and Stop; 7: Shutdown.
23.	ECU Stop Lamp	(0-7)	7	
24.	ECU Warning Lamp	(0-7)	1	
25.	ECU Protect Lamp	(0-7)	1	
<b>Generator Setting</b>				
1.	AC System	(0~3)	0	0: 3P4W; 1: 3P3W; 2: 2P3W; 3: 1P2W.
2.	Poles	(2-64)	4	Numbers of generator pole, used for calculating starter rotate speed when there is not speed sensor.
3.	Rated Voltage	(30~30000)V	230	To offer standards for detecting of gens' over/under voltage and loading voltage. (It is primary voltage when using voltage transformer; it is line voltage when AC system is 3P3W while it is phase voltage when using other AC system).
4.	Loading Voltage	(0~200.0)%	90.0	Percentage of generator rated voltage; it is



No.	Items	Parameters	Defaults	Description
				detected when the controller prepares to load; when the generating voltage is below the load voltage. It won't enter normally running period.
5.	Gen Rated Frequency	(10.0-75.0)Hz	50.0	Offer standards for detecting over/under/load frequency.
6.	Loading Frequency	(0~200.0)%	90	Percentage of generator rated frequency; when generator frequency is under load frequency, it won't enter normal running.
7.	Volt. Trans.(PT)	(0~1)	0	0: Disable; 1:Enable
8.	Gen Over Volt 1 Set	(0-1)	1	0: Disable 1: Enable
		(0-200.0)%	120.0	Set value is gen rated volt percentage.
		(0-200.0)%	118.0	Return value is gen rated volt percentage.
		(0-3600)s	3	Delay value
		(0-7)	7	Action
9.	Gen Over Volt 2 Set	(0-1)	1	0: Disable 1: Enable
		(0-200.0)%	110.0	Set value is gen rated volt percentage.
		(0-200.0)%	108.0	Return value is gen rated volt percentage.
		(0-3600)s	5	Delay value
		(0-7)	1	Action
10.	Gen Under Volt 1 Set	(0-1)	1	0: Disable 1: Enable
		(0-200.0)%	80.0	Set value is gen rated volt percentage.
		(0-200.0)%	82.0	Return value is gen rated volt percentage.
		(0-3600)s	3	Delay value
		(0-7)	7	Action
11.	Gen Under Volt 2 Set	(0-1)	1	0: Disable 1: Enable
		(0-200.0)%	84.0	Set value is gen rated volt percentage.
		(0-200.0)%	86.0	Return value is gen rated volt percentage.
		(0-3600)s	5	Delay value
		(0-7)	1	Action
12.	Gen Over Freq. 1 Set	(0-1)	1	0: Disable 1: Enable
		(0-200.0)%	114.0	Set value is gen rated freq. percentage.
		(0-200.0)%	112.0	Return value is gen rated freq. percentage.
		(0-3600)s	2	Delay value
		(0-7)	7	Action
13.	Gen Over Freq. 2 Set	(0-1)	1	0: Disable 1: Enable
		(0-200.0)%	110.0	Set value is gen rated freq. percentage.
		(0-200.0)%	108.0	Return value is gen rated freq. percentage.
		(0-3600)s	5	Delay value
		(0-7)	1	Action
14.	Gen Under Freq. 1 Set	(0-1)	1	0: Disable 1: Enable
		(0-200.0)%	80.0	Set value is gen rated freq. percentage.
		(0-200.0)%	82.0	Return value is gen rated freq. percentage.



No.	Items	Parameters	Defaults	Description
		(0-3600)s (0-7)	3 7	Delay value Action
15.	Gen Under Freq. 2 Set	(0-1) (0-200.0)% (0-200.0)% (0-3600)s (0-7)	1 84.0 86.0 5 1	0: Disable 1: Enable Set value is gen rated freq. percentage. Return value is gen rated freq. percentage. Delay value Action
16.	Harmonic Display	(0-1)	0	0: Disable 1: Enable
17.	Volt Unbalance 1	(0-1) (0-200.0)% (0-200.0)% (0-3600)s (0-7)(0-1)	1 10.0 5.0 5 1	0: Disable 1: Enable Set value is gen degree of unbalance. Return value is gen degree of unbalance. Delay value Action
18.	Volt Unbalance 2	(0-1) (0-200.0)% (0-200.0)% (0-3600)s (0-7)	0 10.0 5.0 5 0	0: Disable 1: Enable Set value is gen degree of unbalance. Return value is gen degree of unbalance. Delay value Action
19.	THD Alarm 1	(0-1) (0-200.0)% (0-200.0)% (0-3600)s (0-7)	0 10.0 5.0 5 0	0: Disable 1: Enable Set value is gen degree of distortion. Return value is gen degree of distortion. Delay value Action
20.	THD Alarm 2	(0-1) (0-200.0)% (0-200.0)% (0-3600)s (0-7)	0 10.0 5.0 5 0	0: Disable 1: Enable Set value is gen degree of distortion. Return value is gen degree of distortion. Delay value Action
21.	CT	(5-6000)/5	500	Ratio of external connected current transformer.
22.	Rated Current	(5-6000)A	500	It is rated current of generator and used for loading current standard.
23.	Over Current 1	(0-1) (0-200.0)% (0-200.0)% (0-3600)s (0-7)	1 120.0 118.0 3 6	0: Disable 1: Enable Set value is percentage of rated current. Return value is percentage of rated current. Delay value Action
24.	Over Current 2	(0-1) (0-200.0)% (0-200.0)% (0-3600)s (0-7)	1 110.0 108.0 5 1	0: Disable 1: Enable Set value is percentage of rated current. Return value is percentage of rated current. Delay value Action
25.	NegSeq Current 1	(0-1)	1	0: Disable 1: Enable



No.	Items	Parameters	Defaults	Description
		(0-200.0)% (0-200.0)% (0-3600)s (0-7)	20.0 18.0 5 1	Set value is percentage of rated current. Return value is percentage of rated current. Delay value Action
26.	NegSeq Current 2	(0-1) (0-200.0)% (0-200.0)% (0-3600)s (0-7)	0 20.0 18.0 5 0	0: Disable 1: Enable Set value is percentage of rated current. Return value is percentage of rated current. Delay value Action
27.	Earth Fault 1	(0-1) (0-200.0)% (0-200.0)% (0-3600)s (0-7)	1 20.0 18.0 5 1	0: Disable 1: Enable Set value is percentage of rated current. Return value is percentage of rated current. Delay value Action
28.	Earth Fault 2	(0-1) (0-200.0)% (0-200.0)% (0-3600)s (0-7)	0 20.0 18.0 5 0	0: Disable 1: Enable Set value is percentage of rated current. Return value is percentage of rated current. Delay value Action
29.	Rated Power(W)	(0-6000)kW	276	Genset rated active power, which is standard of loading active power.
30.	Rated Power(var)	(0-6000)kvar	210	Genset rated reactive power, which is standard of loading reactive power.
31.	Load Ramp Rate	(0.1-100.0)%/s	3.0	机组每加载设置的带载斜率延时点功率, 延时设置的带载斜率延时时间后按设置的带载斜率继续加载到目标功率。
32.	Load Ramp Point	(0.1-40.0)%	10.0	
33.	Load Ramp Delay	(0-30)s	0	
34.	Unload Ramp Rate	(0.1-100.0)%/s	3.0	Genset unloading speed
35.	Over Power 1 Set	(0-1) (0-200.0)% (0-200.0)% (0-3600)s (0-7)	1 120.0 118.0 3 6	0: Disable 1: Enable Set value is percentage of active power. Return value is percentage of active power. Delay value Action
36.	Over Power 2 Set	(0-1) (0-200.0)% (0-200.0)% (0-3600)s (0-7)	1 110.0 108.0 5 1	0: Disable 1: Enable Set value is percentage of active power. Return value is percentage of active power. Delay value Action
37.	Reverse Power 1 Set	(0-1) (0-200.0)% (0-200.0)% (0-3600)s (0-7)	1 10.0 8.0 3 7	0: Disable 1: Enable Set value is percentage of active power. Return value is percentage of active power. Delay value Action
38.	Reverse Power 2	(0-1)	1	0: Disable 1: Enable



No.	Items	Parameters	Defaults	Description
	Set	(0-200.0)% (0-200.0)% (0-3600)s (0-7)	5.0 3.0 5 1	Set value is percentage of rated active power. Return value is percentage of rated active power. Delay value Action
39.	Loss Excition 1	(0-1) (0-200.0)% (0-200.0)% (0-3600)s (0-7)	1 20.0 18.0 5 1	0: Disable 1: Enable Set value is percentage of rated reactive power. Return value is percentage of rated reactive power. Delay value Action
40.	Loss Excition 2	(0-1) (0-200.0)% (0-200.0)% (0-3600)s (0-7)	1 20.0 18.0 5 0	0: Disable 1: Enable Set value is percentage of rated reactive power. Return value is percentage of rated reactive power. Delay value Action
41.	Power Factor Low 1	(0-1) (0-1.00) (0-1.00) (0-3600)s (0-7)	1 0.70 0.75 5 1	0: Disable 1: Enable Set value is gen power factor. Set value is gen power factor. Delay value Action
42.	Power Factor Low 2	(0-1) (0-1.00) (0-1.00) (0-3600)s (0-7)	0 0.70 0.75 5 0	0: Disable 1: Enable Set value is gen power factor. Set value is gen power factor. Delay value Action

**Switch Setting**

1.	Close Time	(0~20.0)s	5.0	Pulse width of switch on. When it is 0, it means output constantly.
2.	Open Time	(0~20.0)s	3.0	Pulse width of switch off. When it is 0, it means output constantly.
3.	Check Time	(0-20.0)s	5.0	Feedback and check time of breaker close status input.

**Analog Sensor Setting**

Temperature Sensor

1.	Curve Type	(0~15)	8	SGD
2.	Open Circuit Action	(0~7)	1	0: None; 1: Warning; 2: Block; 3: Safety Trip; 4: Safety Stop; 5: Trip; 6: Trip and Stop; 7: Shutdown.





No.	Items	Parameters	Defaults	Description
3.	High Temp. Alarm 1 Set	(0-1)	1	0: Disable 1: Enable
		((-50)-300)°C	98	Set value is engine temperature value.
		((-50)-300)°C	96	Set value is engine temperature value.
		(0-3600)s	3	Delay value
		(0-7)	7	Action
4.	High Temp. Alarm 2 Set	(0-1)	1	0: Disable 1: Enable
		((-50)-300)°C	95	Set value is engine temperature value.
		((-50)-300)°C	93	Set value is engine temperature value.
		(0-3600)s	5	Delay value
		(0-7)	1	Action
5.	Low Temp. Alarm Set	(0-1)	0	0: Disable 1: Enable
		((-50)-300)°C	70	Set value is engine temperature value.
		((-50)-300)°C	75	Set value is engine temperature value.
		(0-3600)s	5	Delay value
		(0-7)	1	Action
<b>Oil Pressure Sensor</b>				
1.	Curve Type	(0~15)	8	SGD
2.	Open Circuit Action	(0~7)	1	0: None; 1: Warning; 2: Block; 3: Safety Trip; 4: Safety Stop; 5: Trip; 6: Trip and Stop; 7: Shutdown.
3.	Low OP Alarm 1 Set	(0-1)	1	0: Disable 1: Enable
		(0-1000)kPa	103	Set value is engine oil pressure value.
		(0-1000)kPa	117	Set value is engine oil pressure value.
		(0-3600)s	2	Delay value
		(0-7)	7	Action
4.	Low OP Alarm 2 Set	(0-1)	1	0: Disable 1: Enable
		(0-1000)kPa	124	Set value is engine oil pressure value.
		(0-1000)kPa	138	Set value is engine oil pressure value.
		(0-3600)s	5	Delay value
		(0-7)	1	Action
<b>Fuel Level Sensor</b>				
1.	Curve Type	(0~15)	0	Not used.
<b>Flexible Sensor 1</b>				
1.	Flexible Sensor 1 Setting	(0~1)	0	0: Disable 1: Enable; Temperature/pressure/fuel level sensors are optional.
<b>Flexible Sensor 2</b>				
1.	Flexible Sensor 2 Setting	(0~1)	0	0: Disable; 1: Enable; Temperature/pressure/fuel level sensors are optional.
<b>Digital Input Ports</b>				
<b>Digital Input Port 1</b>				
1.	Contents Setting	(0~70)	31	Remote start (on demand).



No.	Items	Parameters	Defaults	Description
2.	Active Type	(0~1)	0	0: Close 1: Open
Digital Input Port 2				
1.	Contents Setting	(0~70)	27	Low oil pressure shutdown input
2.	Active Type	(0~1)	0	0: Close 1: Open
Digital Input Port 3				
1.	Contents Setting	(0~70)	26	High temperature shutdown input
2.	Active Type	(0~1)	0	0: Close 1: Open
Digital Input Port 4				
1.	Contents Setting	(0~70)	13	Gen GCB close status input
2.	Active Type	(0~1)	0	0: Close 1: Open
Digital Input Port 5				
1.	Contents Setting	(0~70)	0	Users-defined
2.	Active Type	(0~1)	0	0: Closed to active 1: Open to active
3.	Arming	(0~3)	3	0: From safety on 1: From starting 2: Always 3: Never
4.	Active Actions	(0~7)	4	0: None; 1: Warning; 2: Block; 3: Safety Trip; 4: Safety Stop; 5: Trip; 6: Trip and Stop; 7: Shutdown.
5.	Active Delay	(0~20.0)s	2.0	Time from detecting active to confirm
6.	Description			LCD displays detailed contents when the input is active.
Digital Input Port 6				
1.	Contents Setting	(0~70)	44	Master choice
2.	Active Type	(0~1)	0	0: Close 1: Open
Digital Input Port 7				
1.	Contents Setting	(0~70)	0	Users-defined.
2.	Active Type	(0~1)	0	0: Close 1: Open
3.	Arming	(0~3)	3	0: From safety on 1: From starting 2: Always 3: Never
4.	Active Actions	(0~7)	4	0: None; 1: Warning; 2: Block; 3: Safety Trip; 4: Safety Stop; 5: Trip; 6: Trip and Stop; 7: Shutdown.
5.	Active Delay	(0~20.0)s	2.0	Time from detecting active to confirm
6.	Description			LCD displays detailed contents when the input is active.
Digital Input Port 8				
1.	Contents Setting	(0-70)	0	User defined.
2.	Active Type	(0-1)	0	0: Closed 1: Open
3.	Arming	(0-3)	3	0: From safety on 1: From starting 2: Always 3: Never
4.	Active Actions	(0-7)	4	0: None; 1: Warning; 2: Block; 3: Safety



No.	Items	Parameters	Defaults	Description
				Trip; 4: Safety Stop; 5: Trip; 6: Trip and Stop; 7: Shutdown.
5.	Active Delay	(0-20.0)s	2.0	Time from detecting active to confirm
6.	Description			LCD displays detailed contents when the input is active.
<b>Digital Input Port 9</b>				
1.	Contents Setting	(0-70)	0	Users-defined
2.	Active Type	(0-1)	0	0: Close 1: Open
3.	Arming	(0-3)	3	0: From safety on 1: From starting 2: Always 3: Never
4.	Active Actions	(0-7)	4	0: None; 1: Warning; 2: Block; 3: Safety Trip; 4: Safety Stop; 5: Trip; 6: Trip and Stop; 7: Shutdown.
5.	Active Delay	(0-20.0)s	2.0	Time from detecting active to confirm
6.	Description			LCD displays detailed contents when the input is active.
<b>Digital Input Port 10</b>				
1.	Contents Setting	(0-70)	0	Users-defined
2.	Active Type	(0-1)	0	0: Close 1: Open
3.	Arming	(0-3)	3	0: From safety on 1: From starting 2: Always 3: Never
4.	Active Actions	(0-7)	4	0: None; 1: Warning; 2: Block; 3: Safety Trip; 4: Safety Stop; 5: Trip; 6: Trip and Stop; 7: Shutdown.
5.	Active Delay	(0-20.0)s	2.0	Time from detecting active to confirm
6.	Description			LCD displays detailed contents when the input is active.
<b>Digital Output Ports</b>				
<b>Digital Output Port 1</b>				
1	Contents Setting	(0~299)	44	Normal generating output
2	Active Type	(0~1)	0	0: Normally open; 1: Normally close
<b>Digital Output Port 2</b>				
1	Contents Setting	(0~299)	48	Common Alarm
2	Active Type	(0~1)	0	0: Normally open; 1: Normally close
<b>Digital Output Port 3</b>				
1	Contents Setting	(0~299)	38	Energise to Stop
2	Active Type	(0~1)	0	0: Normally open; 1: Normally close
<b>Digital Output Port 4</b>				
1	Contents Setting	(0~299)	35	Idle Control
2	Active Type	(0~1)	0	0: Normally open; 1: Normally close
<b>Digital Output Port 5</b>				
1	Contents Setting	(0~299)	30	Open Gen Output



No.	Items	Parameters	Defaults	Description
2	Active Type	(0~1)	0	0: Normally open; 1: Normally close
<b>Digital Output Port 6</b>				
1	Contents Setting	(0~299)	29	Close Gen Output
2	Active Type	(0~1)	0	0: Normally open; 1: Normally close
<b>Digital Output Port 7</b>				
1	Contents Setting	(0~299)	0	Not Used
2	Active Type	(0~1)	0	0: Normally open; 1: Normally close
<b>Digital Output Port 8</b>				
1	Contents Setting	(0~299)	0	Not Used
2	Active Type	(0~1)	0	0: Normally open; 1: Normally close
<b>Scheduled Run</b>				
1	Scheduled Run	(0~1)	0	0: Disable; 1: Enable Circular setting (monthly, weekly, daily), non-start time setting, continuous time setting are available.
<b>Scheduled Not Run</b>				
1	Scheduled Not Run	(0~1)	0	0: Disable; 1: Enable Circular setting (monthly, weekly, daily), non-start time setting, continuous time setting are available.
<b>Maintenance Setting</b>				
1	Maintenance	(0-1)	0	0: Disable; 1: Enable Maintenance time, alarm action can be set.
<b>Alternative Configuration</b>				
1	Alt. Config. 1	(0-1)	0	0: Disable; 1: Enable Power supply system, rated voltage, rated frequency, rated speed, rated current, rated active power, rated reactive power, GOV SW1, AVR SW1 can be set.
2	Alt. Config. 2	(0-1)	0	0: Disable; 1: Enable
3	Alt. Config. 3	(0-1)	0	0: Disable; 1: Enable
<b>Sync Setting</b>				
Auto Sync				
1	GOV Output Type	(0-1)	1	0: Internal Relays; 1: Internal Analogue
2	GOV Reverse	(0-1)	0	0: Disable; 1: Enable
3	GOV Action	(0-2)	1	0: None; 1: Adjust to Rated; 2: Adjust Center Point
4	AVR Output	(0-2)	2	0: None 1: Internal Relays; 2: Internal Analogue
5	AVR Reverse	(0-1)	0	0: Disable; 1: Enable
6	AVR Action	(0-2)	1	0: None; 1: Adjust to Rated; 2: Adjust Center Point



No.	Items	Parameters	Defaults	Description
<b>Sync Check</b>				
1	Dead Bus Volt	(10-50)V	30	It is considered Bus no power when Bus voltage is lower than dead Bus voltage.
2	Check Volt	(0-30)V	3	It is considered voltage synchronization when the voltage difference between Generator and Bus is lower than synchronization voltage difference.
3	Check Pos Freq	(0-2.00)Hz	0.20	It is considered frequency synchronization when the frequency difference between Generator and Bus is less than 'Check Pos Freq' but more than 'Check Neg Freq'.
4	Check Neg Freq	(0-2.00)Hz	0.10	
5	Check Phase Ang	(0-20)°	10	It is considered 'Check Phase Angle' when the initial phase difference is lower than synchronization phase difference.
6	Phase Angle Offset	(0-360)°	0	Gen initial phase will add pre-set phase offset based on the sampling initial phase.
7	Fail Sync Delay	(5.0-300.0) s	60.0	If sync signals are not detected during the set "Fail Sync Delay", controller will initiate corresponding alarms based on the 'Fail Sync Act'.
8	Fail Sync Act	(0-7)	1	
<b>Multi Sync</b>				
1.	Num.On MSC Bus	(1-32)	2	It is the minimum MSC number.
2.	MSC Fail Act	(0-7)	1	0: None; 1: Warning; 2: Block; 3: Safety Trip; 4: Safety Stop; 5: Trip; 6: Trip and Stop; 7: Shutdown.
3.	MSC Baud Rate	(0-3)	1	0: 500kbps; 1: 250kbps; 2: 125kbps; 3: 50kbps.
4.	Starting Option	(0-1)	1	0: Start All; 1: Start Sets on demand
5.	Start All Time	(0-3600)s	120	When starting option is set as 'start all', controller will stop corresponding gensets as required after 'Start All Time' delay.
6.	Balance Enable	(0-1)	0	0: Disable; 1: Enable
7.	Balance Hours	(1-1000)h	1	When the input is active, the controller will start/stop the genset automatically according to the running time and the pre-set balanced running time. Balance running gensets should be configured as the same priority.
8.	Sets on Bus	(1-32)	1	Set the number of closed gensets on the bus.
9.	Call Sets Mode	(0-1)	0	0: Gen Power (%); 1: Available Power.
10.	Call More Sets(%)	(0-100)%	80	Schedule the load value of other gensets when start the genset on demand.



No.	Items	Parameters	Defaults	Description
11.	Call Less Sets(%)	(0-100)%	50	Schedule the load value of other genset when start the genset on demand.
12.	Call More Sets(W)	(0-6000)kW	200	Schedule the available power value of other genset when start the genset on demand.
13.	Call Less Sets(W)	(0-6000)kW	400	Schedule the available power value of other genset when start the genset on demand.
14.	Freq Feedback	(0-200)%	10	It is frequency feedback coefficient in configuring active power distribution.
15.	Volt Feedback	(0-200)%	10	It is voltage feedback coefficient in configuring active power distribution.
16.	Ground Relay Close Fail	(0-7)	7	0: None; 1: Warning; 2: Block; 3: Safety Trip; 4: Safety Stop; 5: Trip; 6: Trip and Stop; 7: Shutdown.
17.	Ground Relay Open Fail	(0-7)	1	0: None; 1: Warning; 2: Block; 3: Safety Trip; 4: Safety Stop; 5: Trip; 6: Trip and Stop; 7: Shutdown.
18.	Static Parallel Delay	(0-600)s	60	If static paralleling is not completed during 'Static Parallel Delay', controller will initiate alarm information.
19.	Economy Fuel	(0-1)	0	0: Disable; 1: Enable All gensets should be configured the same economy fuel value.
20.	Economy Fuel (%)	(0-100)%	60	It is the economy fuel percentage of genset.
21.	Economy Sawp(W)	(0-6000)kW	200	Economy fuel consumption starts exchange if difference value of the total rated power of the exchange gensets and the total power of the current loading gensets is greater than the set exchange power, otherwise no exchange is performed.
22.	GOV Droop	(0-1)	0	0: Disable; 1: Enable
23.		(0-200.0)%	101.0	It is the percentage of no-load frequency and rated frequency.
24.		(0-200.0)%	100.0	It is the percentage of full-load frequency and rated frequency.
25.	AVR Droop	(0-1)	0	0: Disable; 1: Enable
26.		(0-200.0)%	101.0	It is the percentage of no-load voltage and rated voltage.
27.		(0-200.0)%	100.0	It is the percentage of full-load voltage and rated voltage.
<b>NEL Settings</b>				
1.	NEL Number	(1-3)	3	Details of function description please see the following description.
2.	NEL Trip	(0-1)	0	



No.	Items	Parameters	Defaults	Description	
3.	NEL Trip 1 Set Value	(0-200)%	90		
4.	NEL Trip 1 Delay	(0-3600)s	5		
5.	NEL Trip 2 Set Value	(0-200)%	100		
6.	NEL Trip 2 Delay	(0-3600)s	1		
7.	NEL Auto Reconnection	(0-1)	0		
8.	NEL Auto Reconnection Set Value	(0-200)%	50		
9.	NEL Auto Reconnection Delay	(0-3600)s	5		
<b>Dummy Load</b>					
1.	DL Number	(1-3)	3		Details of function description please see the following description.
2.	DL Connection	(0-1)	0		
3.	DL Connection Value 1	(0-200)%	20		
4.	DL Connection Delay 1	(0-3600)s	5		
5.	DL Connection Value 2	(0-200)%	10		
6.	DL Connection Delay 2	(0-3600)s	1		
7.	DL Auto Trip	(0-1)	0		
8.	DL Trip Value	(0-200)%	50		
9.	DL Trip Delay	(0-3600)s	5		
<b>Heavy Load</b>					
1.	Heavy Load 1 Request Load	(0-6000)kW	400	Details of function description please see the following description.	
2.	Heavy Load 1 Rated Load	(0-6000)kW	200		
3.	Heavy Load 1 Stable Delay	(0-3600)s	5		
4.	Heavy Load 1 ACK Delay	(0-3600)s	5		
5.	Heavy Load 2 Request Load	(0-6000)kW	400		
6.	Heavy Load 2 Rated Load	(0-6000)kW	200		
7.	Heavy Load 2 Stable Delay	(0-3600)s	5		



No.	Items	Parameters	Defaults	Description
8.	Heavy Load 2 ACK Delay	(0-3600)s	5	
<b>Sync Calibration</b>				
MSC				
1.	MSC ID	(0-31)	1	It is the ID in the MSC communication network, which indicates that the MSC ID in the entire communication network should be unique.
2.	Module Priority	(0-31)	0	Smaller the value, higher priority.
<b>Sync Control</b>				
1.	Slip Freq	(0-1.00)Hz	0.10	Adjust generator frequency so that gen frequency is greater than slip frequency. Phase synchronization adjustment is conducted when the sync difference frequency is set to 0.
2.	Sync Freq(Volt)	(0-500)%	20	Gain(P)
		(0-2000)%	20	Stability(I)
		(0-2000)%	0	Rate of change (D)
3.	Sync Freq(Relay)	(0.25-4.00)Hz	1.20	Response
		(0.05-1.60)s	0.20	Stability
		(0-100)%	10	Gain
		(0-10.0)%	1.0	Dead area
4.	Sync Volt(Volt)	(0-500)%	20	Gain(P)
		(0-2000)%	20	Stability(I)
		(0-2000)%	0	Rate of change (D)
5.	Sync Volt(Relay)	(0.25-4.00)Hz	1.20	Response
		(0.05-1.60)s	0.20	Stability
		(0-100)%	10	Gain
		(0-10.0)%	1.0	Dead area
6.	Sync Phase(Stable Time)	(0.1-20.0)s	2.0	Sync. confirmation time during phase sync adjustment
7.	Sync Phase(Volt)	(0-500)%	20	Gain(P)
		(0-2000)%	20	Stability(I)
		(0-2000)%	0	Rate of change (D)
8.	SyncPhase(Relay)	(0.25-4.00)Hz	1.20	Response
		(0.05-1.60)s	0.20	Stability
		(0-100)%	10	Gain
		(0-10.0)%	1.0	Dead area
<b>Load Control</b>				
1.	kW Control(Volt)	(0-500)%	20	Gain(P)
		(0-2000)%	20	Stability(I)
		(0-2000)%	0	Rate of change (D)





No.	Items	Parameters	Defaults	Description
2.	kWControl(Relay)	(0.25-4.00)Hz	1.20	Response
		(0.05-1.60)s	0.20	Stability
		(0-100)%	10	Gain
		(0-10.0)%	1.0	Dead area
3.	kvar Control(V)	(0-500)%	20	Gain(P)
		(0-2000)%	20	Stability(I)
		(0-2000)%	0	Rate of change (D)
4.	kvar Control(R)	(0.25-4.00)Hz	1.20	Response
		(0.05-1.60)s	0.20	Stability
		(0-100)%	10	Gain
		(0-10.0)%	1.0	Dead area
<b>Load</b>				
1.	Load Minimum	(0-100.0)%	1.0	It is the load percentage when the soft unload is opened.
2.	Load Mode	(0-3)	0	0: Gen; 1: Mains; 2: Takeover; 3: Load Control.
3.	Export Mode(W)	(0-1)	0	0: Fixed Power; 1: Frequency-Power. It is active when Load mode is Gen control mode.
4.	Export Mode(var)	(0-1)	0	0: Fixed Power; 1: Voltage-Power. It is active when Load mode is Gen control mode.
5.	Export Power(W)	(0-100.0)%	30.0	It is used to load control.
6.	Export Power Opt	(0-1)	0	0: kvar Reactive Power Control; 1: PF Power Factor Control.
7.	Export Power(var)	(0-100.0)%	8.0	It is used to load control.
8.	Analogue Adjust(W)	(0-1)	0	0: Disable; 1: Enable. When it is enabled, flexible sensor 1 is used as analog input. It is active when active power output mode is configured as Fixed Power.
9.	Analogue Adjust(var)	(0-1)	0	0: Disable; 1: Enable. When it is enabled, flexible sensor 2 is used as analog input. It is active when reactive power output mode is configured as Fixed Power.
10.	Export Curve(W)			Configure gen frequency-active power curve. It is active when active power output mode is configured as Frequency-Power.
11.	Export Curve(var)			Configure gen voltage-reactive power curve.



No.	Items	Parameters	Defaults	Description
				It is active when active power output mode is configured as Voltage-Power.
<b>GOV/AVR</b>				
1.	GOV SW1	(0-20.00)	0	Center voltage, default 0V.
2.	GOV SW2	(0-10.00)	2.00	Voltage range, default (-2.5~+2.5V).
3.	AVR SW1	(0-20.00)	0	Center voltage, default 0V.
4.	AVR SW2	(0-10.00)	2.0	Voltage range, default (-2.5~+2.5V).
<b>Mains Split Setting</b>				
1.	AC System	(0~3)	0	0: 3P4W; 1: 3P3W; 2: 2P3W; 3: 1P2W.
2.	Rated Voltage	(30~30000)V	230	Offer standards for detecting mains' over/under voltage. (It is primary voltage when voltage transformer is used; it is line voltage when AC system is 3P3W while it is phase voltage when other AC system is used).
3.	Mains Rated Frequency	(10.0~75.0)Hz	50.0	Offer standards for detecting over/under frequency.
4.	Volt. Trans.(PT)	(0-1)	0	0: Disable ; 1: Enable
5.	Mains Split Action	(0-1)	0	0: Trip and Stop; 1: Aux. Mains Fail.
6.	Mains Over Voltage	(0-1) (0-200.0)% (0-20.0)s	1 110.0 0.1	Set value is percentage of mains rated volt.
7.	Mains Under Voltage	(0-1) (0-200.0)% (0-20.0)s	1 90.0 0.1	
8.	Mains Over Frequency	(0-1) (0-200.0)% (0-20.0)s	1 101.0 0.1	
9.	Mains Under Frequency	(0-1) (0-200.0)% (0-20.0)s	1 99.0 0.1	Set value is mains rated frequency's percentage.
10.	ROCOF	(0-1) (0-1.00)Hz/s (0-20.0)s	1 0.20 0.1	Set value is frequency change rate of mains (ROCOF).
11.	Vector Shift	(0-1) (0-20.0)° (0-20.0)s	1 6.0 0.1	Set value is phase angle's change rate of mains voltage waveform (VECTOR SHFT).
<b>Expansion Module</b>				
1.	Expand DIN16	(0-1)	0	0: Disable ; 1: Enable
2.	Expand DOUT16	(0-1)	0	0: Disable ; 1: Enable
3.	Expand AIN24 1	(0-1)	0	0: Disable ; 1: Enable



No.	Items	Parameters	Defaults	Description
4.	Expand AIN24 2	(0-1)	0	0: Disable ; 1: Enable

SmartGen



## 7.2 ENABLE DEFINITION OF PROGRAMMABLE OUTPUT PORTS

### 7.2.1 DEFINITION OF DIGITAL OUTPUT PORTS

**Table 17 Definition of Digital Output Ports**

No.	Type	Description
0	Not Used	
1	Custom Period 1	Details of function description please see the following description.
2	Custom Period 2	
3	Custom Period 3	
4	Custom Period 4	
5	Custom Period 5	
6	Custom Period 6	
7	Custom Combined 1	
8	Custom Combined 2	
9	Custom Combined 3	
10	Custom Combined 4	
11	Custom Combined 5	
12	Custom Combined 6	
13	Reserved	
14	Reserved	
15	Gas Choke On	Act in cranking. Action time is the preset time for it.
16	Gas Ignition	Act when genset is starting, and disconnect when engine is stopped.
17	Air Flap Control	Act on over speed shutdown and emergence stop. Air inflow can be closed to stop the engine quicker.
18	Audible Alarm	Act on warning, shutdown, and trips. An annunciator can be connected externally. If 'alarm mute' configurable input port is active, this is prohibited.
19	Louver Control	Act when genset is starting and disconnect when genset is stopped completely.
20	Fuel Pump Control	It is controlled by limit values of level sensor fuel pump.
21	Heater Control	It is controlled by heating limit values of temperature sensor.
22	Cooler Control	It is controlled by cooler limit values of temperature sensor.
23	Oil Pre-supply Output	Act from 'crank on' to 'safety on'.
24	Generator Excite	Output in start process. If there is not generator frequency during hi-speed running, it shall output for 2 seconds again.
25	Pre-Lubricate	Act from pre-heating to safety run.
26	Remote Control Output	This port is controlled by communication (PC).
27	Reserved	
28	Sync Indication	
29	Close Gen Output	It can control generating switch to take load.
30	Open Gen Output	It can control generating switch to take off load.



No.	Type	Description
31	Reserved	
32	Reserved	
33	Start Relay	
34	Fuel Relay	Act when genset is starting and disconnect when stop is completed. When gas timer is enabled, fuel relay output is used to control gas valve.
35	Idle Control	It is used for engine with idling control. Close before starting and open in warming up delay; Close during stopping idle mode and open when stop is completed.
36	Speed Raise Relay	Act during warming up time.
37	Speed Drop Relay	Act between the period 'stop idle' and 'failed to stop'.
38	Energize to Stop	It is used for engines with ETS electromagnet. Close when stop idle is over and open when pre-set 'ETS delay' is over.
39	Speed Drop Pulse	Act for 0.1s when controller enters 'stop idle', used for control parts of ECU dropping to idle speed.
40	ECU Stop	Used for ECU engine and control its stop.
41	ECU Power Supply	Used for ECU engine to control its power.
42	Speed Raise Pulse	Act for 0.1s when controller enters warming up delay; used for control parts of ECU raising to normal speed.
43	Crank Success	Close when a successful start signal is detected.
44	Gen OK	Act when generator is normally running.
45	Gen Load Available	Act between normal running and hi-speed cooling.
46	Reserved	
47	Synchronizing	Act when controller is synchronizing.
48	Common Alarm	Act when genset common warning, common shutdown, common trip alarms occur.
49	Common Trip and Stop	Act when common trip and stop alarm occurs.
50	Common Shutdown	Act when common shutdown alarm occurs.
51	Common Trip	Act when common trip alarm occurs.
52	Common Warn	Act when common warning alarm occurs.
53	Common Block	
54	Battery Over Voltage	Act when battery's over voltage warning alarm occurs.
55	Battery Under Voltage	Act when battery's low voltage warning alarm occurs.
56	Charge Alternator Failure	Act when charging failure warning alarm occurs.
57	Common Safety Stop	
58	Common Safety Trip	
59	Reserved	
60	ECU Warning	Indicates ECU sends a warning signal.
61	ECU Shutdown	Indicates ECU sends a shutdown signal.
62	ECU Com Fail	Indicates controller is not communicating with ECU.
63	PWM Voltage Raise	When output type of AVR is set as 'Relay output', controller



No.	Type	Description
64	PWM Voltage Drop	adjusts voltage and reactive power via 'Sync Raise Volt' and 'Sync Drop Volt'.
65	PWM Speed Raise	When output type of GOV is set as 'Relay output', controller adjusts speed and power via 'Sync Raise Speed' and 'Sync Drop Speed'.
66	PWM Speed Drop	
67	Reserved	
68	Reserved	
69	Digital Input 1 Active	Act when input port 1 is active.
70	Digital Input 2 Active	Act when input port 2 is active.
71	Digital Input 3 Active	Act when input port 3 is active.
72	Digital Input 4 Active	Act when input port 4 is active.
73	Digital Input 5 Active	Act when input port 5 is active.
74	Digital Input 6 Active	Act when input port 6 is active.
75	Digital Input 7 Active	Act when input port 7 is active.
76	Digital Input 8 Active	Act when input port 8 is active.
77	Digital Input 9 Active	Act when input port 9 is active.
78	Digital Input 10 Active	Act when input port 10 is active.
79	Reserved	
80	Reserved	
81	Exp DI Input 1 Active	
82	Exp DI Input 2 Active	
83	Exp DI Input 3 Active	
84	Exp DI Input 4 Active	
85	Exp DI Input 5 Active	
86	Exp DI Input 6 Active	
87	Exp DI Input 7 Active	
88	Exp DI Input 8 Active	
89	Exp DI Input 9 Active	
90	Exp DI Input 10 Active	
91	Exp DI Input 11 Active	
92	Exp DI Input 12 Active	
93	Exp DI Input 13 Active	
94	Exp DI Input 14 Active	
95	Exp DI Input 15 Active	
96	Exp DI Input 16 Active	
97-98	Reserved	
99	Emergency Stop	Act when emergency stop alarm occurs.
100	Fail To Start	Act when start failure alarm occurs.
101	Fail To Stop	Act when stop failure alarm occurs.
102	Under Speed Warn	Act when under speed alarm occurs.
103	Under Speed Shutdown	Act when under speed alarm (except warning) occurs.



No.	Type	Description
104	Over Speed Warn	Act when over speed warning occurs.
105	Over Speed Shutdown	Act when over speed alarm (except warning) occurs.
106	Reserved	
107	Reserved	
108	Reserved	
109	Gen Over Freq. Warn	Act when generator over frequency warning occurs.
110	Gen Over Freq. Shut	Act when generator over frequency alarm (except warning) occurs.
111	Gen Over Volt Warn	Act when generator over voltage warning occurs.
112	Gen Over Volt Shut	Act when generator over voltage alarm (except warning) occurs.
113	Gen Under Freq. Warn	Act when generator low frequency warning occurs.
114	Gen Under Freq. Shut	Act when generator low frequency alarm (except warning) occurs.
115	Gen Under Volt. Warn	Act when generator low voltage warning occurs.
116	Gen Under Volt. Shut	Act when generator low voltage alarm (except warning) occurs.
117	Gen Loss of Phase	Act when generator loss phase occurs.
118	Gen Phase Sequence Wrong	Act when generator reverse phase occurs.
119	Over Power Warn	Act when gen over power warning occurs.
120	Over Power Alarm	Act (except warning) when over power warning occurs.
121	Gen Reverse Power Warn	Act when gen inverse power warning occurs.
122	GenReverse Power Alarm	Act except warning) when controller detects generator have reverse power.
123	Over Current Warn	Act when over current warning occurs.
124	Over Current Alarm	Act when gen over current alarm (except warning) occurs.
125-133	Reserved	
134	NEL1 Trip	Details of function description please see the following description.
135	NEL2 Trip	
136	NEL3 Trip	
137-138	Reserved	
139	High Temp Warn	Act when hi-temperature warning occurs.
140	Low Temp Warn	Act when low temperature warning occurs.
141	High Temp Alarm	Act when hi-temperature alarm (except warning) occurs.
142	Reserved	
143	Low OP Warn	Act when low oil pressure warning occurs.
144	Low OP Alarm	Act when low oil pressure alarm (except warning) occurs.
145	Oil Pressure Open Circuit	Act when oil pressure sensor is open circuit.
146	Reserved	
147	Low Fuel Level Warn	Act when controller has low fuel level warning alarm.
148	Low Fuel Level Alarm	Act when controller has low fuel level alarm (except warning).
149	Reserved	



No.	Type	Description
150	Flexible Sensor 1 High Warn	Act when controller has flexible sensor 1 high warning alarm.
151	Flexible Sensor 1 Low Warn	Act when controller has flexible sensor 1 low warning alarm.
152	Flexible Sensor 1 High Alarm	Act when controller has flexible sensor 1 high alarm (except warning).
153	Flexible Sensor 1 Low Alarm	Act when controller has flexible sensor 1 low alarm (except warning).
154	Flexible Sensor 2 High Warn	Act when controller has flexible sensor 2 high warning alarm.
155	Flexible Sensor 2 Low Warn	Act when controller has flexible sensor 2 low warning alarm.
156	Flexible Sensor 2 High Alarm	Act when controller has flexible sensor 2 high alarm (except warning).
157	Flexible Sensor 2 Low Alarm	Act when controller has flexible sensor 2 low alarm (except warning).
158-161	Reserved	
162	Exp1 Ch15 High Alarm	Act when expansion AIN24 1 sensor 15 high alarm (except warning) occurs.
163	Exp1 Ch15 High Warn	Act when expansion AIN24 1 sensor 15 high warning occurs.
164	Exp1 Ch15 Low Alarm	Act when expansion AIN24 1 sensor 15 low alarm (except warning) occurs.
165	Exp1 Ch15 Low Warn	Act when expansion AIN24 1 sensor 15 low warning occurs.
166	Exp1 Ch16 High Alarm	Act when expansion AIN24 1 sensor 16 high alarm (except warning) occurs.
167	Exp1 Ch16 High Warn	Act when expansion AIN24 1 sensor 16 high warning occurs.
168	Exp1 Ch16 Low Alarm	Act when expansion AIN24 1 sensor 16 low alarm (except warning) occurs.
169	Exp1 Ch16 Low Warn	Act when expansion AIN24 1 sensor 16 low warning occurs.
170	Exp1 Ch17 High Alarm	Act when expansion AIN24 1 sensor 17 high alarm (except warning) occurs.
171	Exp1 Ch17 High Warn	Act when expansion AIN24 1 sensor 17 high warning occurs.
172	Exp1 Ch17 Low Alarm	Act when expansion AIN24 1 sensor 17 low alarm (except warning) occurs.
173	Exp1 Ch17 Low Warn	Act when expansion AIN24 1 sensor 17 low warning occurs.
174	Exp1 Ch18 High Alarm	Act when expansion AIN24 1 sensor 18 high alarm (except warning) occurs.
175	Exp1 Ch18 High Warn	Act when expansion AIN24 1 sensor 18 high warning occurs.
176	Exp1 Ch18 Low Alarm	Act when expansion AIN24 1 sensor 18 low alarm (except warning) occurs.
177	Exp1 Ch18 Low Warn	Act when expansion AIN24 1 sensor 18 low warning occurs.
178	Exp1 Ch19 High Alarm	Act when expansion AIN24 1 sensor 19 high alarm (except warning) occurs.
179	Exp1 Ch19 High Warn	Act when expansion AIN24 1 sensor 19 high warning occurs.
180	Exp1 Ch19 Low Alarm	Act when expansion AIN24 1 sensor 19 low alarm (except warning) occurs.





No.	Type	Description
181	Exp1 Ch19 Low Warn	Act when expansion AIN24 1 sensor 19 low warning occurs.
182	Exp1 Ch20 High Alarm	Act when expansion AIN24 1 sensor 20 high alarm (except warning) occurs.
183	Exp1 Ch20 High Warn	Act when expansion AIN24 1 sensor 20 high warning occurs.
184	Exp1 Ch20 Low Alarm	Act when expansion AIN24 1 sensor 20 low alarm (except warning) occurs.
185	Exp1 Ch20 Low Warn	Act when expansion AIN24 1 sensor 20 low warning occurs.
186	Exp1 Ch21 High Alarm	Act when expansion AIN24 1 sensor 21 high alarm (except warning) occurs.
187	Exp1 Ch21 High Warn	Act when expansion AIN24 1 sensor 21 high warning occurs.
188	Exp1 Ch21 Low Alarm	Act when expansion AIN24 1 sensor 21 low alarm (except warning) occurs.
189	Exp1 Ch21 Low Warn	Act when expansion AIN24 1 sensor 21 low warning occurs.
190	Exp1 Ch22 High Alarm	Act when expansion AIN24 1 sensor 22 high alarm (except warning) occurs.
191	Exp1 Ch22 High Warn	Act when expansion AIN24 1 sensor 22 high warning occurs.
192	Exp1 Ch22 Low Alarm	Act when expansion AIN24 1 sensor 22 low alarm (except warning) occurs.
193	Exp1 Ch22 Low Warn	Act when expansion AIN24 1 sensor 22 low warning occurs.
194	Exp1 Ch23 High Alarm	Act when expansion AIN24 1 sensor 23 high alarm (except warning) occurs.
195	Exp1 Ch23 High Warn	Act when expansion AIN24 1 sensor 23 high warning occurs.
196	Exp1 Ch23 Low Alarm	Act when expansion AIN24 1 sensor 23 low alarm (except warning) occurs.
197	Exp1 Ch23 Low Warn	Act when expansion AIN24 1 sensor 23 low warning occurs.
198	Exp1 Ch24 High Alarm	Act when expansion AIN24 1 sensor 24 high alarm (except warning) occurs.
199	Exp1 Ch24 High Warn	Act when expansion AIN24 1 sensor 24 high warning occurs.
200	Exp1 Ch24 Low Alarm	Act when expansion AIN24 1 sensor 24 low alarm (except warning) occurs.
201	Exp1 Ch24 Low Warn	Act when expansion AIN24 1 sensor 24 low warning occurs.
202-219	Reserved	
220	DL1 Connection	Details of function description please see the following description.
221	DL2 Connection	
222	DL3 Connection	
223	Ground Relay Output	Details of function description please see the following description.
224	Redundancy Active	Details of function description please see the following description. (Not for HGM9510N)
225	HC1 ACK Output	Details of function description please see the following description.
226	HC2 ACK Output	Details of function description please see the following



No.	Type	Description
		description.
227-229	Reserved	
230	Stop Mode	Act when the system is in stop mode.
231	Manual Mode	Act when the system is in Manual mode.
232	Reserved	Reserved
233	Auto Mode	Act when the system is in Auto mode.
234	Gen Onload Indication	
235-239	Reserved	
240-279	PLC Flag1~40	PLC flag output.
280-299	Reserved	

SmartGen



### 7.2.2 DEFINED PERIOD OUTPUT

Defined Period output is composed by 2 parts, **period output S1** and **condition output S2**.



While **S1** and **S2** are **TRUE** synchronously, **OUTPUT**;

While **S1** or **S2** is **FALSE**, **NOT OUTPUT**.

**Period output S1** can set generator's one or more period output freely, can set the delayed time and output time after enter into period.

**Conditional output S2** can set as any conditions in output ports.

**NOTE:** when delay time and output time both are 0 in period output S1, it is TRUE in this period.

Output period: start

Delay output time: 2s

Output time: 3s

Condition output contents: output port 1 is active

Close when condition output active/inactive: close when active (disconnect when inactive);

Output port 1 active, after enter "starts time" and delay 2s, this defined period output is outputting, after 3s, stop outputting;

Output port 1 inactive, defined output period is not outputting.

### 7.2.3 DEFINED COMBINATION OUTPUT

Defined combination output is composed by 3 parts, **or condition output S1**, **or condition output S2** and **and condition output S3**.

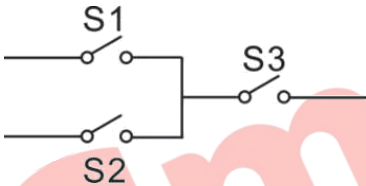

**S1** or **S2** is **TRUE**, while **S3** is **TRUE**, Defined combination output is outputting;

**S1** and **S2** are **FALSE**, or **S3** is **FALSE**, Defined combination output is not outputting.

**NOTE:** S1, S2, S3 can be set as any contents except for "defined combination output" in the output setting.

**NOTE:** 3 parts of defined combination output (S1, S2, S3) couldn't include or recursively include themselves.

For example:

Contents of or condition output S1: output port 1 is active;

Close when or condition output S1 is active /inactive: close when active (disconnect when inactive);

Contents of or condition output S2, output port 2 is active;

Close when or condition output S2 is active /inactive: close when active (disconnect when inactive);

Contents of or condition output S3: output port 3 is active;

Close when or condition output S3 is active /inactive: close when active (disconnect when inactive);

When input port 1 active or input port 2 active, if input port 3 is active, Defined combination output is outputting; If input port 3 inactive, Defined combination output is not outputting;

When input port 1 inactive and input port 2 inactive, whatever input port 3 is active or not, Defined combination output is not outputting.



**7.3 DEFINED CONTENTS OF PROGRAMMABLE INPUT PORTS**

**Table 18 Definition of Digital Input Ports**

No.	Type	Description
0	Users Configured	Users-defined alarm. Active range: Never: input inactive. Always: input is active all the time. From crank: detecting as soon as start. From safety on: detecting after safety on run delay.
1	Reserved	
2	Alarm Mute	Can prohibit 'Audible Alarm' output when input is active.
3	Reset Alarm	Can reset shutdown alarm and trip alarm when input is active.
4	60Hz Active	Use for CANBUS engine and it is 60Hz when input is active.
5	Lamp Test	All LED indicators are illuminating when input is active.
6	Panel Lock	All buttons in panel is inactive except navigation buttons and there is  in the left top corner in LCD when input is active.
7	Redundancy Active	Not available for HGM9510N.
8	Idle Control Mode	Under voltage/frequency/speed protection is inactive.
9	Inhibit Auto Stop	In <b>Auto</b> mode, during generator normal running, when input is active, prohibit generator shutdown automatically.
10	Inhibit Auto Start	In <b>Auto</b> mode, prohibit generator start automatically when input is active.
11	Inhibit Scheduled Start	In <b>Auto</b> mode, prohibit fixed timing start genset when input is active.
12	Gen Close Inhibit	When input is active and "Gen Close" needs to be output, "Gen Close" process will wait and will not close genset.
13	Gen Closed Input	Connect generator loading switch's auxiliary point.
14	Inhibit Gen Load	Prohibit genset switch on when input is active.
15	Reserved	
16	Reserved	
17	Auto Mode Lock	When input is active, controller enters into Auto mode.
18	Auto Mode Invalid	When input is active, controller won't work under Auto mode. Auto key and simulate auto key input do not work.
19	Static Parallel	
20	Black Start Input	
21	Inhibit Alarm Stop	All shutdown alarms are prohibited except emergence stop.(Means battle mode or override mode)
22	Instrument Mode	All outputs are prohibited in this mode.
23	Reserved	
24	Reset Maintenance	Controller will set maintenance time and date as default when input is active.
25	Reserved	
26	Aux. High Temp	



No.	Type	Description
		Connected sensor digital input.
27	Aux. Low OP	Connected sensor digital input.
28	Remote Start (On Load)	In <b>Auto</b> mode, when input active, genset can be started and with load after genset is OK; when input inactive, genset will stop automatically.
29	Remote Start (Off Load)	In <b>Auto</b> mode, when input is active, genset can be started and without load after genset is OK; when input is inactive, genset will stop automatically.
30	Aux. Manual Start	In <b>Auto</b> mode, when input active, genset will start automatically; when input inactive, genset will stop automatically
31	Remote Start (On Demand)	In <b>Auto</b> mode, when input active, all genset that need to be parallel will start according to the priority and calling other generator according to the load.
32	Reserved	
33	Simulate Stop key	An external button (Not Self-locking) can be connected and pressed as simulate panel.
34	Simulate Manual key	
35	Reserved	
36	Simulate Auto key	An external button (Not Self-locking) can be connected and pressed as simulate panel.
37	Simulate Start key	
38	Simulate G-Load key	This is simulate G-close key.
39	Simulate M-Load key	This is simulate M-open key.
40	NEL Manual Trip	An external button (Not Self-locking) can be connected. Details of function description please see the following.
41	NEL Manual Re-connection	
42	Power Manager Mode	Power management mode will be displayed on the LCD when the input is active. In this mode, the controller will control genset synchronize, power sharing, scheduled start, scheduled stop, generator closed, generator opened but genset start or stop. Details of function description please see the following.
43	Mains Parallel Mode	The genset will output constant power when the input is active. And meanwhile the mains split is active.
44	First Priority	It is the highest priority when the input is active. Used for main/standby genset selection.
45-46	Reserved	
47	Alternative Config 1	Users can set different parameters to make it easy to select current configuration via input port.
48	Alternative Config 2	
49	Alternative Config 3	
50	Balance Test	
51	Speed Raise	
52	Speed Drop	
53	Voltage Raise	
54	Voltage Drop	



No.	Type	Description
55	Reserved	
56	Low Coolant Level	Connect with water level sensor digital input port.
57	Detonation Shutdown	Connect with detection module alarm input port.
58	Gas Leak Shutdown	Connect with detection module alarm input port.
59	DL Manual Connect	An external button (Not Self-locking) can be connected. Details of function description please see the following.
60	DL Manual Trip	
61	HC1 Request	
62	HC1 Feedback	
63	HC2 Request	
64	HC2 Feedback	
65	Ground Relay Closed	
66	Reserved	
67	Reserved	
68	Reserved	
69	Reserved	
70	Reserved	





## 7.4 SELECTION OF SENSORS

**Table 19 Sensor Selection**

No.		Description	Remark
1	Temperature Sensor	0 Not used 1 Custom Res Curve 2 Custom (4-20)mA curve 3 Custom (0-5)V curve 4 VDO 5 CURTIS 6 DATCON 7 SGX 8 SGD 9 SGH 10 PT100 11 SUSUKI 12 PRO 13-15 Reserved	Defined resistance's range is (0~6)kΩ.
2	Pressure Sensor	0 Not used 1 Custom Res Curve 2 Custom (4-20)mA curve 3 Custom (0-5)V curve 4 VDO 10Bar 5 CURTIS 6 DATCON 10Bar 7 SGX 8 SGD 9 SGH 10 VDO 5Bar 11 DATCON 5Bar 12 DATCON 7Bar 13 SUSUKI 14 PRO 15 Reserved	Defined resistance's range is (0~6)kΩ.
3	Oil Level Sensor	0 Not used 1 Custom Res Curve 2 Custom (4-20)mA curve 3 Custom (0-5)V curve 4 SGD 5 SGH 6~15 Reserved	Defined resistance's range is (0~6)kΩ.

**NOTE:** User should make special declare when order controller if your engine temperature sensor, fuel level sensor or flexible sensor 2 uses non-resistance sensor.



## 7.5 CONDITIONS OF CRANK DISCONNECT SELECTION

**Table 20 Crank Disconnect Conditions**

No.	Setting Description
0	Gen frequency
1	Speed sensor
2	Speed sensor + Gen frequency
3	Oil pressure
4	Oil pressure + Gen frequency
5	Oil pressure + Speed sensor
6	Oil pressure + Speed sensor + Gen frequency

### NOTES:

- 1) There are 3 conditions to make starter disconnected with engine, that is, speed sensor, generator frequency and engine oil pressure. They all can be used separately. We recommend that engine oil pressure should be used with speed sensor and generator frequency together, in order to make the starter motor separated with engine as soon as possible.
- 2) Speed is the collected signal by magnetic sensor and magnetic sensor is the magnetic equipment installed in starter for detecting flywheel teeth.
- 3) When speed is selected, users must ensure that the number of flywheel teeth is the same with setting, otherwise, "over speed stop" or "under speed stop" may be caused.
- 4) If genset is without magnetic sensor, please don't select corresponding items, otherwise, "start fail" or "loss speed signal" may be caused.
- 5) If genset is without oil pressure sensor, please don't select corresponding items.
- 6) If speed is not selected in crank disconnect setting, the rotating speed displayed on controller is calculated by generating signals.

## 8 PARAMETERS SETTING

**CAUTION:** Please change the controller parameters when generator is in standby mode only (e. g. Start conditions selection, configurable input, configurable output, various delay etc.), otherwise, alarming to stop and other abnormal conditions may happen.

**NOTE:** Maximum set value must over minimum set value in case that the condition of too high as well as too low will happen.

**NOTE:** When the warning alarm is set, please set the correct return value; otherwise, maybe there is abnormal alarm. When the maximum value is set, the return value must be less than the set value; when the minimum value is set, the return value must be over the set value.

**NOTE:** Please set the generator frequency value as low as possible when the genset is cranking, in order to make the starter be separated quickly as soon as crank disconnection happens.

**NOTE:** Configurable input could not be set as the same items; otherwise, there are abnormal functions. However, the configurable output can be set as the same items.



## 9 SENSOR SETTING

- 1) When sensors are reselected, the sensor curves will be transferred into the standard value. For example, if temperature sensor is SGX (120°C resistor type), its sensor curve is SGD (120°C resistor type); if select the SGH (120°C resistor type), the temperature sensor curve is SGH curve.
- 2) When there is difference between standard sensor curves and used sensor curves, users can adjust it in the “sensor curve type”.
- 3) When the sensor curve is inputted, x value (resistor) must be inputted from small to large, otherwise, mistake occurs.
- 4) If sensor type is selected as “none”, sensor curve is not working.
- 5) If the corresponding sensor has alarm switch only, users must set this sensor as “none”, otherwise, shutdown or warning may occur.
- 6) The headmost or backmost values in the vertical coordinates can be set as the same as below.

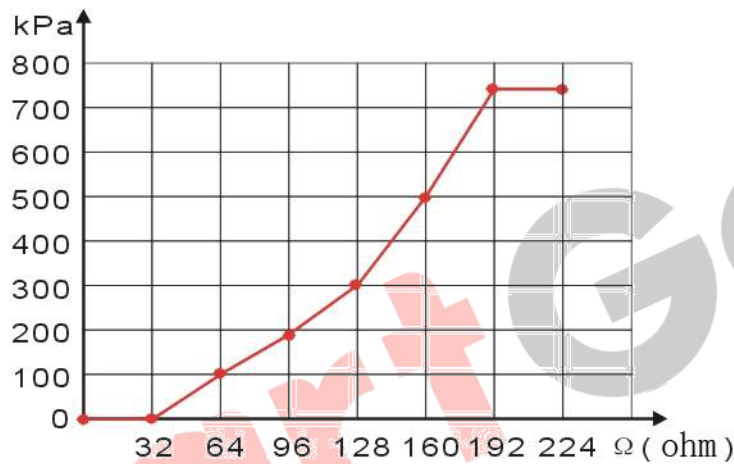

**Fig. 4 Sensor Curve Diagram**

**Table 21 Normal Pressure Unit Conversion Form**

	pa	kgf/cm <sup>2</sup>	bar	psi
1Pa	1	$1.02 \times 10^{-5}$	$1 \times 10^{-5}$	$1.45 \times 10^{-4}$
1kgf/cm <sup>2</sup>	$9.8 \times 10^4$	1	0.98	14.2
1bar	$1 \times 10^5$	1.02	1	14.5
1psi	$6.89 \times 10^3$	$7.03 \times 10^{-2}$	$6.89 \times 10^{-2}$	1

## 10 COMMISSIONING

### 10.1 STEP 1: SINGLE UNIT DEBUGGING

- 1) Check the parameter configurations of the controller;
- 2) Check the genset wiring connections and MSC CAN wiring connection between the units. (e.g. if 3 generators are correctly connected, SYNC screen will display Module Number: 3).
- 3) In manual mode, check whether engine and generator data is normal;
- 4) In manual mode check whether switch open and close is normal;
- 5) In manual mode, after closing the breaker check whether generator frequency can be adjusted to the rated frequency (e.g. set the rated frequency as 52Hz/48Hz);
- 6) In manual mode, after closing the breaker check whether generator voltage can be adjusted to the rated voltage (e.g. set the rated voltage as 240V/220V);
- 7) Activate manual start on-load, and check whether power factor, active power and reactive power are normal; if negative value occurs, check generator voltage and current phase sequences, the incoming line direction of current transformer, and secondary current dotted terminal of current transformer;
- 8) In manual mode do performance tests according to the national standards.

**▲NOTE:** Please refer to *HGM9500 SYNCHRONIZATION PLAN LIST* for more information on GOV and AVR settings.

### 10.2 STEP 2: MANUAL PARALLEL OPERATION OFF-LOAD

- 1) Manually close parallel sets, and check whether the parallel synchronization is steady and whether the close impulse current is too high or not;
- 2) After the genset is connected in parallel off-load, check whether the current display has very big loop current;
- 3) After the genset is connected in parallel off-load, observe whether the active power, reactive power outputs are "0"; if they are not 0, observe whether there is power oscillation; if they are 0, users can properly modify the gain and stability values, or adjust the engine GOV or generator AVR gain and stability potentiometer, in order to avoid active and reactive power oscillation and make output close to 0.

### 10.3 STEP 3: MANUAL PARALLEL OPERATION ON-LOAD

- 1) After the gensets are connected in parallel manually, perform on-load test and check whether active and reactive power is evenly distributed between all the gensets;
- 2) After the gensets are connected in parallel manually, perform ramp on-load test to see if there is high overshoot or power oscillation during this period; if there is, regulate load ramp;
- 3) After the gensets are connected in parallel manually on-load, perform ramp off-load test to see if genset breaker opens after reaching minimum set value (%);
- 4) After the gensets are connected in parallel manually, perform impact load test and damp load test to check if there is power oscillation.

### 10.4 STEP 4: AUTOMATIC PARALLEL OPERATION

When the controller is in auto status, if digital input 'remote start on-load (on demand)' is active, it will carry out automatic parallel, start and stop operation. There are 3 ways of automatic parallel operation:

- 1) Start on demand: the module with the highest priority starts firstly. When load exceeds the pre-set start maximum percentage, the second according to the priority module will start the genset. Synchronize the gensets and make them share load. When load falls lower than the preset minimum stop percentage, after stop delay the second module breaker will be open and the module will be cooled down and stopped.
- 2) Start all sets initially: all the modules start at the same time; the first module to reach load condition closes first; when other modules reach load condition, they synchronize one by one. After that the modules monitor the load. If load value falls below module pre-set shutdown minimum percentage, the module with lowest priority enters stop delay and then cools down and stops. If load exceeds the preset start maximum percentage, the generators that are at rest will all start again.
- 3) Balanced engine running time: Engine with the lowest total running time B starts first. When the running genset total running time exceeds the other genset balanced running time B, then the genset with the next lowest total running time starts (both “start on demand” or “start all sets initially” modes are possible); after other gensets are connected and synchronized in parallel, breaker open and unloading are performed automatically. All the gen-sets are repeatedly started and stopped according to their total running time.

## 11 TYPICAL APPLICATION

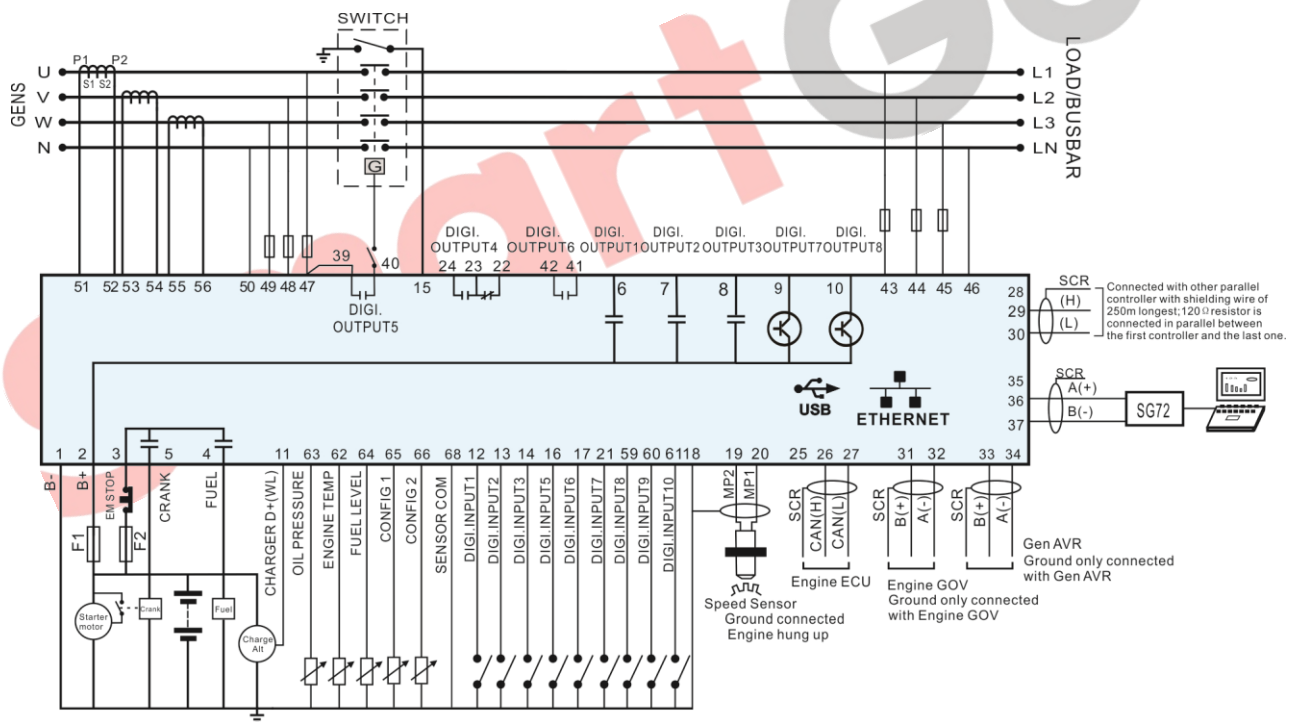

**Fig. 5 HGM9510N/9530N 3-Phase 4-Wire Typical Application Diagram**

**NOTE:** Fuse F1: min. 2A; max. 20A; Fuse F2: max. 32A; Users should select the suitable fuse depending on practical application.

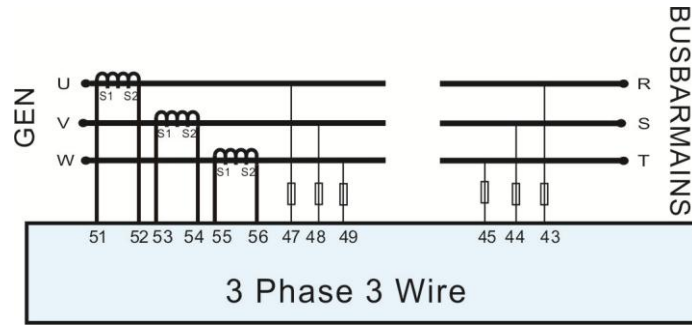

Fig. 6 3-Phase 3-Wire Typical Application Diagram

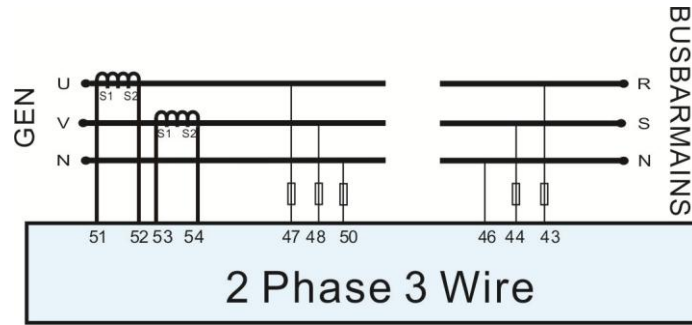

Fig. 7 2-Phase 3-Wire Typical Application Diagram

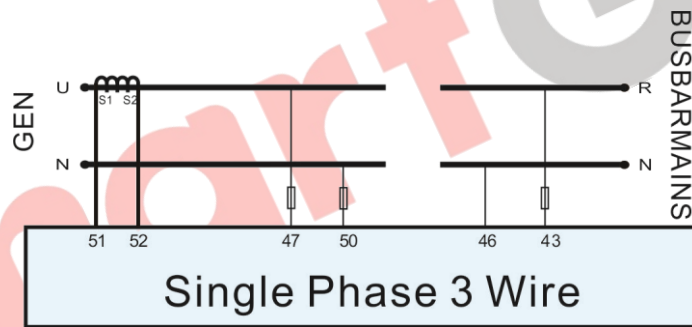
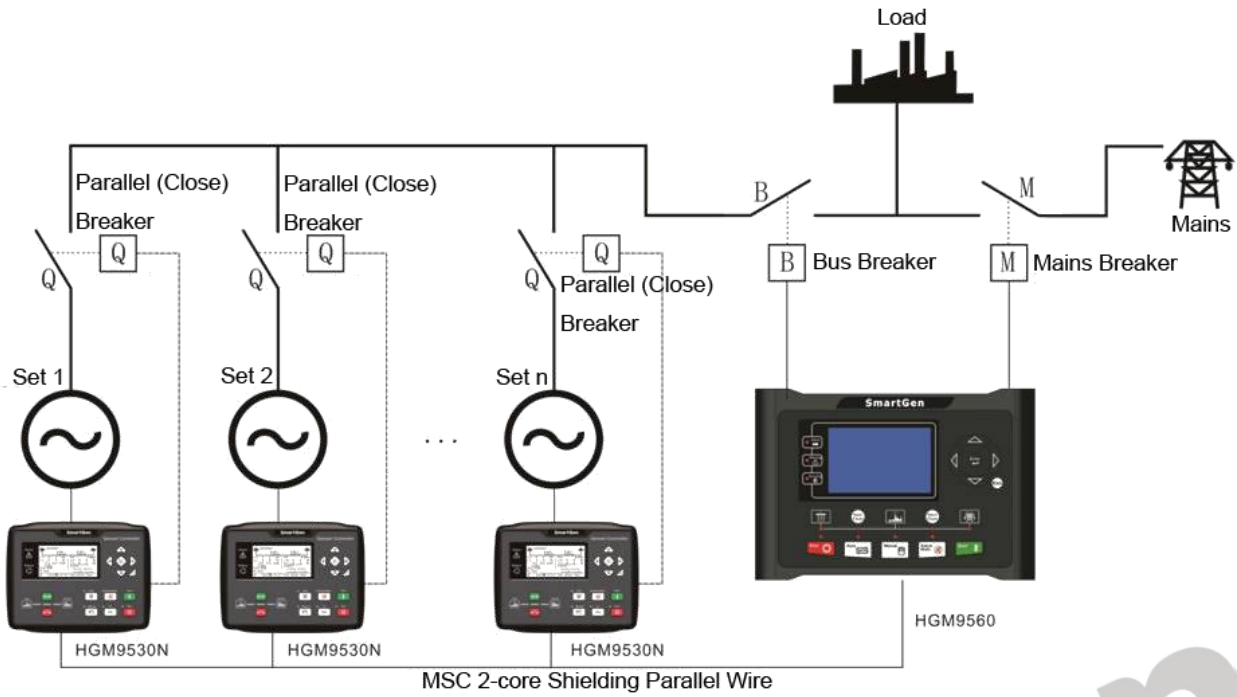

Fig. 8 Single Phase 3-Wire Typical Application Diagram



**Fig. 9 HGM9510N/9530N Multi-genset Parallel Application Graph**

**NOTE:** Mains parallel function for HGM9510N/9530N controller can be selected via configurable input port. In mains parallel mode, generator will run in parallel with mains and it will only be able to output a fixed amount of power. (Set load mode as Gen control mode).



## 12 POWER MANAGEMENT MODE

Power management mode is to be selected via a digital input port.

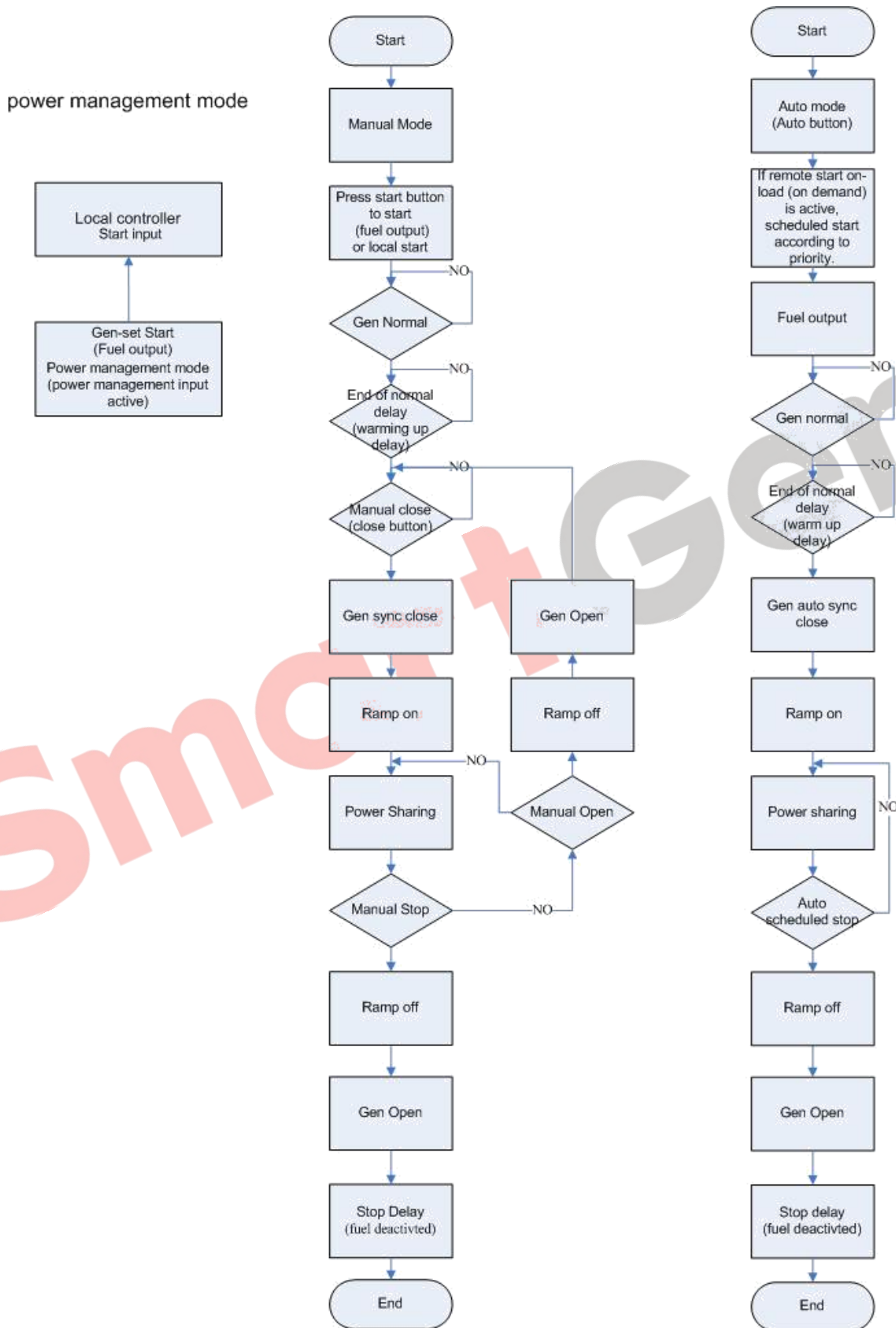

Fig.10 - Power Management Logic

### 13 NEL TRIP DESCRIPTION

Non-essential Load---NEL is the abbreviation.

The controller can control the NEL1, NEL2 and NEL3 to trip separately. The order of the essentiality is: NEL3 > NEL2 > NEL1

◆ **Auto Trip:**

When NEL auto trip is enabled:

If the genset power has exceed the NEL trip value, after the trip delay, NEL1 will trip the earliest, and then is NEL2, NEL3;

When NEL auto reconnection is enabled:

If the genset power has fallen below the auto reconnection set value, after the auto reconnection delay, NEL3 will reconnection the earliest, and then is NEL2, NEL1;

t1: NEL Trip Delay  
t2: Reconnection Delay

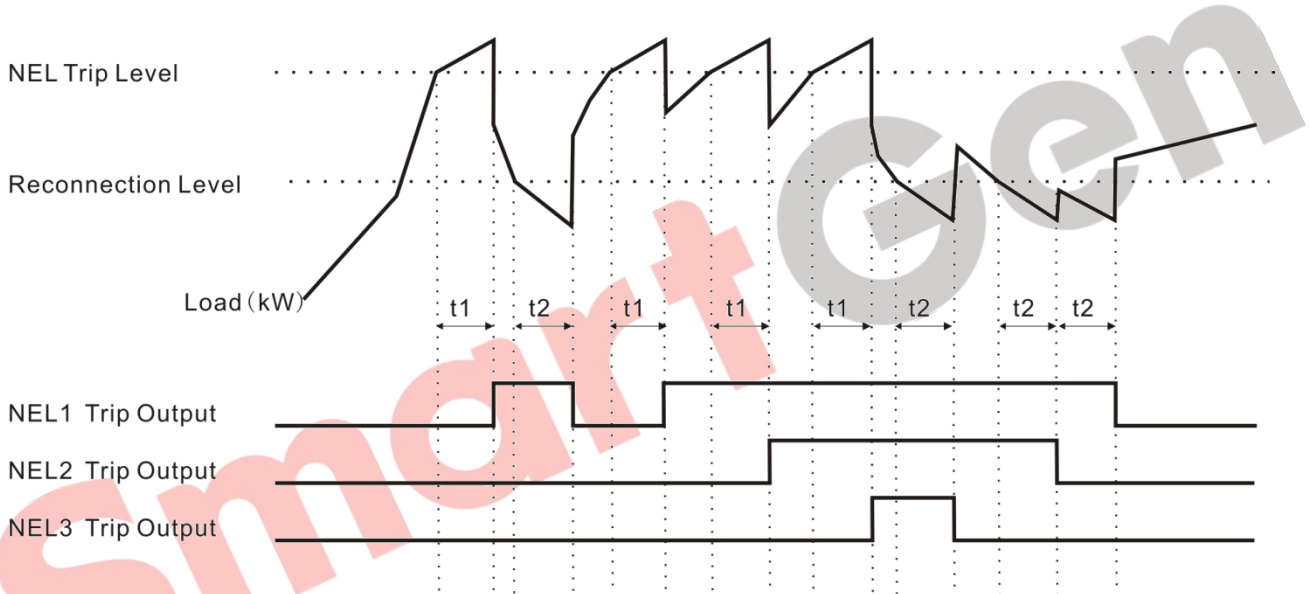

**Fig.11 - NEL Sequence**

◆ **Manual Trip**

If NEL manual trip input is active (earthed failing edge is active), NEL1 will trip without delay; If NEL manual trip input is active again, NEL2 will trip; If NEL manual trip input is active the third time, NEL3 will trip. During this process, the controller do not detect if the genset power has exceed the NEL trip value or not.

If NEL manual reconnection input is active (earthed failing edge is active), NEL3 will reconnect without delay; If NEL manual reconnection input is active again, NEL2 will reconnect; If NEL manual reconnection input is active the third time, NEL1 will reconnect. During this process, the controller detects the genset power: if the genset power has fallen below the NEL reconnection value, then the input is active; if it doesn't, the input is deactivated.

**▲NOTE:** When auto trip and auto reconnection are enabled, manual trip is still active.

## 14 DUMMY LOAD CONNECTION

Dummy Load ---- DL for short.

The controller can control the 3 ways of DL connect separately. The order of the essentiality is: DL1 > DL2 > DL3

◆ Auto operation:

When DL auto connect is enabled:

If the genset power has fallen below the DL connection value, after the connection delay, DL1 will connect the earliest, and then is DL2, DL3;

When DL auto disconnect is enabled:

If the genset power has exceed the DL disconnect value, after the disconnect delay, DL3 will disconnect the earliest, and then is DL2, DL1;

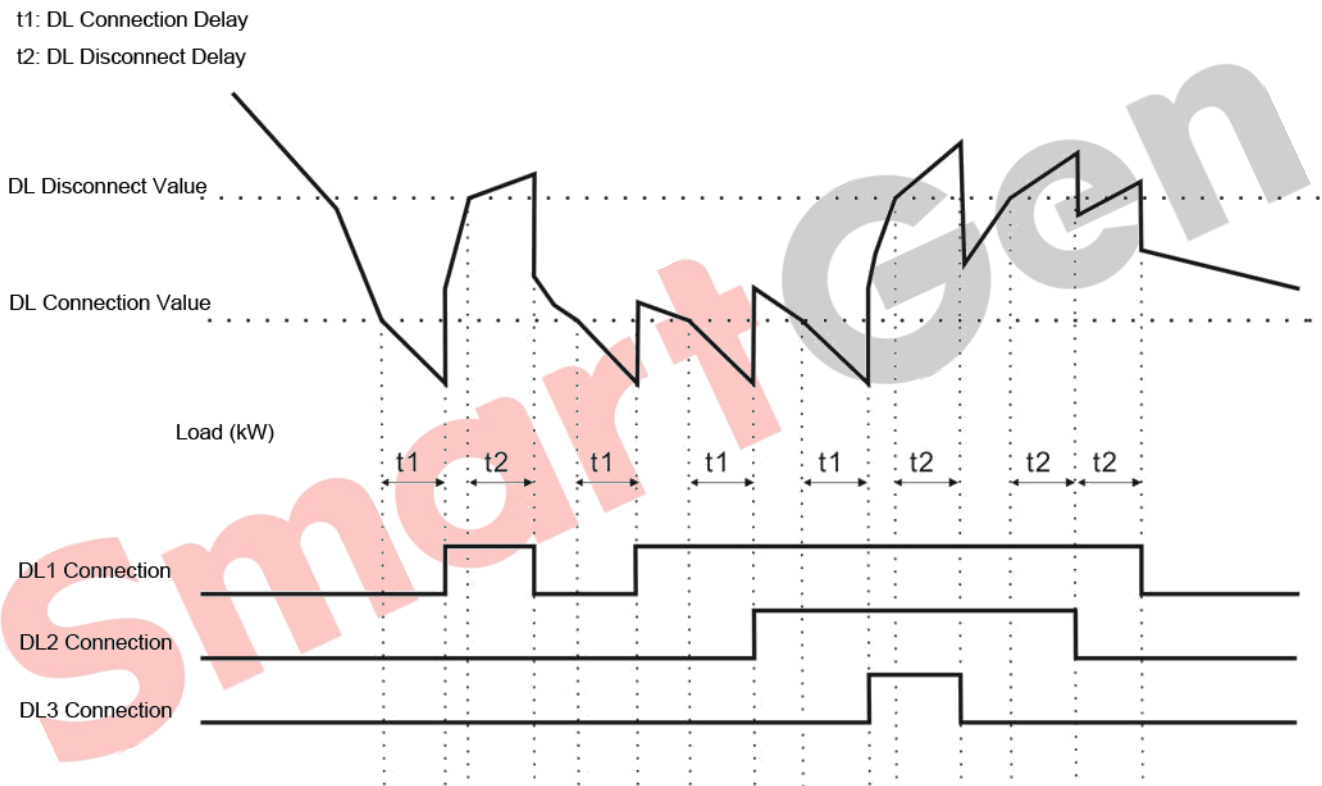

**Fig.12 - DL Sequence**

◆ Manual Operation

If manual DL connect input is active (earthed failing edge is active), DL1 will connect without delay; If manual DL connect input is active again, DL2 will connect; If manual DL connect input is active the third time, DL3 will connect. During this process, the controller will detect if the genset power has fallen the DL connection value or not. If genset power is below DL connection value, this input is active, otherwise, it will be ignored.

If manual DL disconnect input is active (earthed failing edge is active), DL3 will disconnect without delay; If manual DL disconnect input is active again, DL2 will disconnect; If manual DL disconnect input is active the third time, DL1 will disconnect.

**▲NOTE:** When auto connection and auto disconnection are enabled, manual operation is still active.





## 15 GROUND BREAKER CONTROL DESCRIPTION

This function can be realized via configuring ground breaker of controller output port.

Priority of closing ground breaker: in the closed gensets, the genset with the biggest rated power has the highest priority to close ground breaker. If genset rated power is the same, it is chosen based on the module priority. When the ground breaker of the highest priority genset fails to close, the second highest priority will be chosen. When there is a grounding breaker open fault in the closed gensets, the other units are prohibited from closing the grounding breaker.

Ground breaker action:

- a. Genset stop: ground breaker opened.
- b. Genset is normal running and gen opened: ground breaker closed.
- c. Genset is normal running and gen closed: ground breaker closed when this genset with the highest priority, otherwise, ground breaker opened.

SmartGen



## 16 PRIORITY RUNNING AND BALANCED RUNNING TIME DESCRIPTION

Different module IDs must be configured for the controller, but the module priority can be the same (the smaller number with the higher priority). Balanced Running Time function is enabled by the controller 'Balance Hours' function. All gensets that need to have balanced running time shall set the same module priority.

Running adjustment principles:

- a. Genset with the higher priority starts firstly and stop lastly.
- b. Gensets with the same priority:

If "Balance Hours" function is enabled, the unit with less running time has higher priority, otherwise, the unit with the smaller ID has higher priority. Running time is user accumulative running time B.

- c. When 'Call Sets Mode' is genset power percentage, if gen load (%) exceeds pre-set 'Call More Sets(%)' limit, the standby genset with higher priority will start up; if gen load (%) falls below pre-set "Call Less Sets(%)" limit after one genset stopped, the genset with lower priority will stop.

- d. When 'Call Sets Mode' is available power, if bus available power (difference value of rated power of closed gensets and current loading power) falls below 'Call More Sets(W)', the standby genset with higher priority will start up; if bus available power exceeds pre-set 'Call Less Sets(W)' limit, the genset with lower priority will stop.

- e. If 'Sets on Bus' is the minimum scheduled sets, the number of genset on the bus is prioritized.

- f. 'Economy Fuel' scheduling function cannot work together with "Balance Hours" scheduling function. If 'Economy Fuel' scheduling is enabled, 'Balance Hours' scheduling function will not work any longer.

**e.g.:** rated power of genset 1 is 100kW, module ID is 1 and priority is 1; rated power of genset 2 is 100kW, module ID is 2 and priority is 2; rated power of genset 3 is 100kW, module ID is 3 and priority is 2, and genset 2 has the same running time with genset 3. The three gensets settings are: 'Balance Hours' is enabled, and 'Balance Hours' is set as 1 hour, 'Call Sets Mode' is genset power percentage and set scheduling start genset percentage is 80% and scheduling stop genset percentage is 50%, 'Sets on Bus' number is 1.

Three gensets are in auto mode, and 'start on demand' is active, then genset 1 starts and takes load.

Current load is 85kW, genset 1 load percentage is 85%, which is above 'Call More Sets (80%)'. Since genset 2 has the same running time with genset 3, but genset 2 ID is smaller than genset 3, so genset 2 will start and take on load.

After running for 1 hour, current load is 90kW, genset 2 load percentage is 45%, running time of genset 2 is longer than genset 3, and then genset 3 will start and take on load. If it meets 'Call Less Sets(%)' condition, genset 2 will ramp-off load and stop.

Current load is 166kW, start genset percentage is 83%, which is above 'Call More Sets (80%)', other gensets will request to start, and then genset 2 will start and take on load.



## 17 ECONOMICAL FUEL CONSUMPTION DESCRIPTION

Economical fuel consumption function is enabled by 'Economy Fuel' setting of the controller. All sets shall be set as the same economical fuel consumption parameters, including 'Economy Fuel', 'Economy Fuel (%)', and 'Economy Swap (W)'.

Management and operation principles:

- a. First of all, use the fewest parallel sets if it is possible. If one set is enough to satisfy the running conditions, don't use two. The rest can be done in the same manner.
- b. Secondly, satisfy economical fuel consumption percentage. The load percentage of the chosen running plan shall not be bigger than and shall be closest to the economical fuel consumption percentage.
- c. It shall be satisfied that the total difference of the two plans' rated powers shall be bigger than the exchange power when the better running plan is employed.
- d. Start/stop management parameters shall still work when the economical fuel consumption enable is active.
- e. 'Economy Fuel' and 'Balance Hours' managements cannot be used at the same time. When 'Economy Fuel' is enabled, 'Balance Hours' shall not be active.

**e.g.** The rated power of Genset 1 is 100kW, Genset 2 300kW, Genset 3 500kW. Settings: "Economy Fuel" enabled, "Economy Swap (W)" 200kW, "Economy Fuel (%)" 50%, "Call MoreSets (%)" 85%, "Call LessSets (%)" 50%.

Current load is 0kW and all of them are power-off. Then Genset 1 starts and loads.

Current load is 60kW, and Genset 1 loading percentage is 60%, which is bigger than "Economy Fuel (%)" 50%. Choose the best running plan Genset 2. Previous plan's rated power is 100kW and the best plan's is 300kW, so the exchange power is not less than 200kW. Genset 2 starts and loads, and Genset 1 unloads and stops.

Current load is 160kW, and Genset 2 loading percentage is 53.3%, which is bigger than "Economy Fuel (%)" 50%.

Choose the best running plan Genset 3 and it satisfies the exchange power. Genset 3 starts and loads, and Genset 2 unloads and stops.

Current load is 310kW, and Genset 3 loading percentage is 62%, which is bigger than "Economy Fuel (%)" 50%. Then choose the best plan Genset 2 + Genset 3. Previous plan's rated power is 500kW and this one is 800kW, which conforms to the exchange power. Genset 2 starts and loads with Genset 3 together.



## 18 STATIC PARALLEL CONNECTION

Static parallel connection function can be chosen by a digital input port.

It applies to fast parallel connection occasions. All gensets disconnect generator excitation and close the switch to start at the same time. After all the generators' speed is up to the loading speed and meanwhile excitation signals are issued. At this time the generator voltage is formed and the genset parallel connection is completed. This procedure spares the time used in the normal parallel connection process when the genset is waiting for all synchronous conditions are satisfied and then close the switch to start. If the genset cannot realize the excitation output condition during the 'Static Para. Delay' period, it exits from "Static Parallel" mode and changes to normal parallel connection mode. The genset opens the switch and excitation outputs. It will wait and until all synchronous conditions are satisfied it closes and starts to work.

This function applies to soft-start loading occasion. For example: when the genset connects to the transformer.

SmartGen

## 19 HEAVY LOAD REQUEST

Each controller can deal with two heavy load requests: HC 1 and HC 2, and  $HC1 > HC2$ . The priority of the controller decides the priority of its heavy load request. That is heavy load request of high priority controllers is prior to response.

When a HC is asking the controller for starting request, the system shall remain the demanded capacity in the busbar until the system predicts that the capacity left in the busbar satisfies the demand after the HC starts.

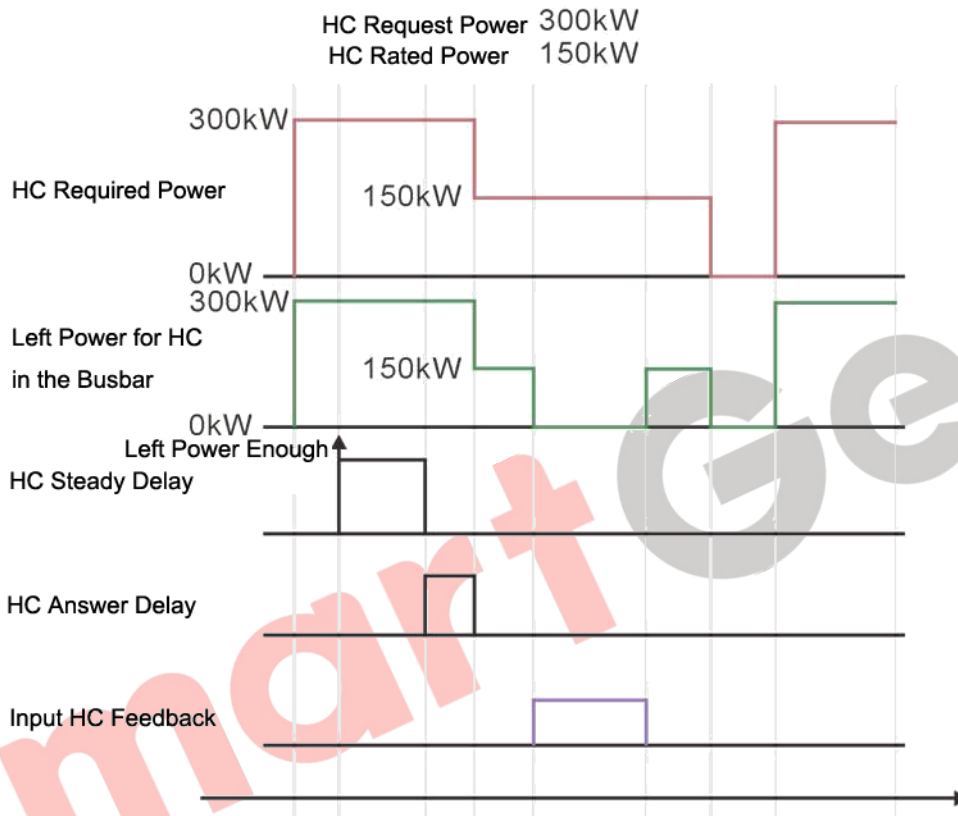

**Fig. 13 HC Sequence Graph**

HC Sequence Graph Description:

- a. HC 1 request power 300kW; HC 1 rated power 150kW;
- b. Left power 300kW for HC 1 in the busbar; if the current genset cannot provide, the spare genset starts.
- c. There is enough remanent power in the busbar and “HC Steady Delay” starts.
- d. After “HC Steady Delay”, the controller starts to output answer signal.
- e. During/after the “Answer Delay”, according to the different status of the feedback and request signal, the busbar has different resolution for HC 1.
- f. If the feedback is valid, the busbar shall not remain power for HC 1.
- g. If the feedback is invalid, the busbar only reserves HC 1 rated power when HC request is valid.
- h. If the feedback is invalid, the busbar will not reserve any power when HC request is invalid.

## 20 CONTROLLER REDUNDANCY

Controller redundancy system is consisted of two modules. They shall be set as the same MSC ID. It shall be set to Main module for main module and set to Redundant module for redundancy module. When the redundancy controllers detect the main module breakdown (redundancy modules do not receive data frames from the main controller in MSC communication, or the redundancy modules receive active redundancy output messages from the main controller.), they will take over the genset controlling, and output redundancy module active messages to the main controller and meanwhile change over controlling messages.

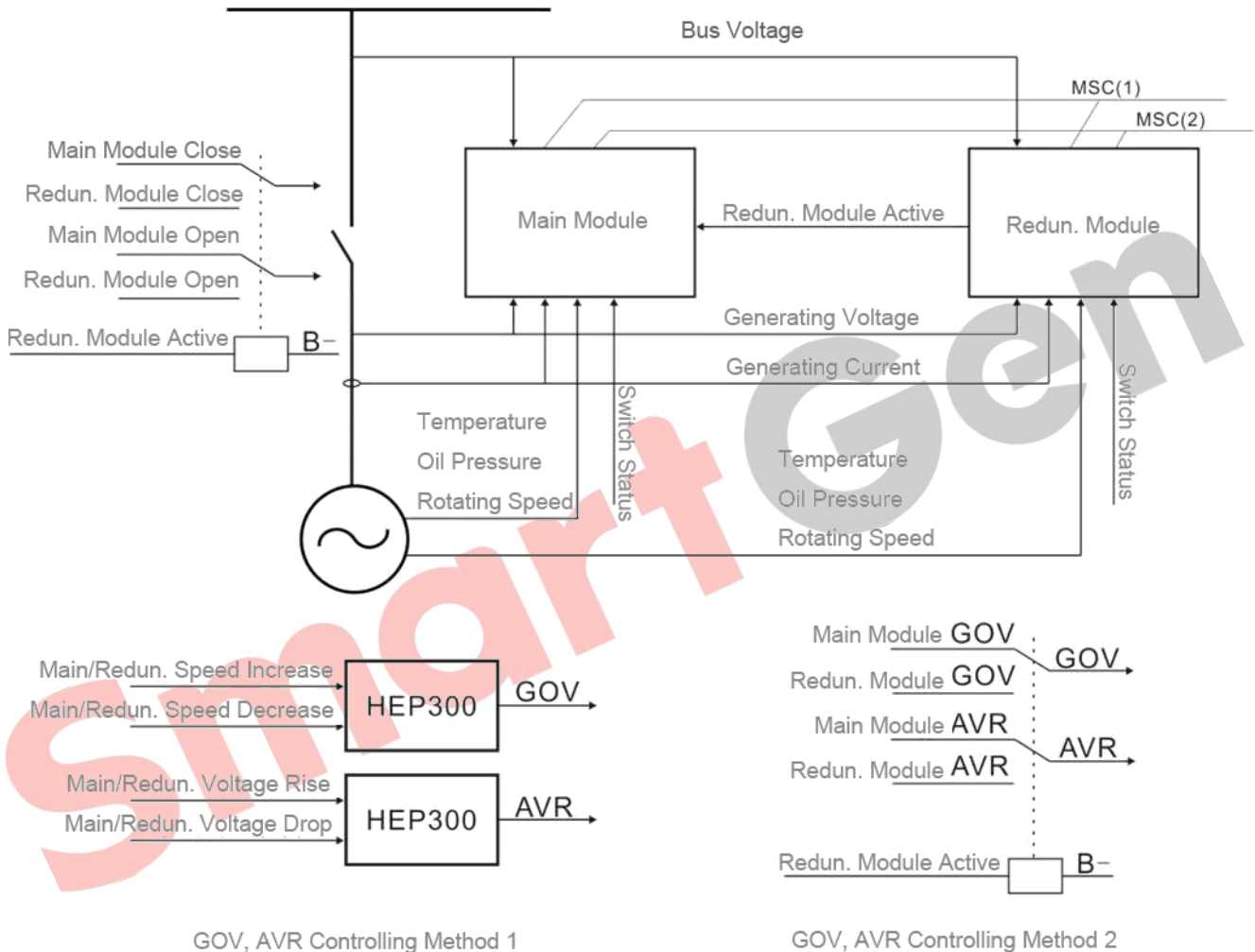

**Fig. 14 Redundancy Controller Connection**

Two methods of GOV, AVR controlling:

**Method 1:** Using electronic potentiometer HEP300. Main module and redundancy module are connected to the digital input ports of speed increase/decrease (voltage rise/drop) in the HEP300, and then analog signal outputs of HEP300 are connected to the speeder (voltage regulator). By using this method when the main module and the redundancy module are switching, the voltage signal outputs to the speeder (voltage regulator) shall not be intercepted and the genset will change over to be controlled by the redundancy controller smoothly.

**Method 2:** Using a relay to directly switch two controllers' GOV, AVR controlling outputs. Its circuit is simple, but when the main module and the redundancy module are switching, the voltage signal outputs to the speeder could be interrupted and it may arise fluctuation on parts of the genset.

## 21 INSTALLATION

The controller is panel built-in design; it is fixed by clips when installed.

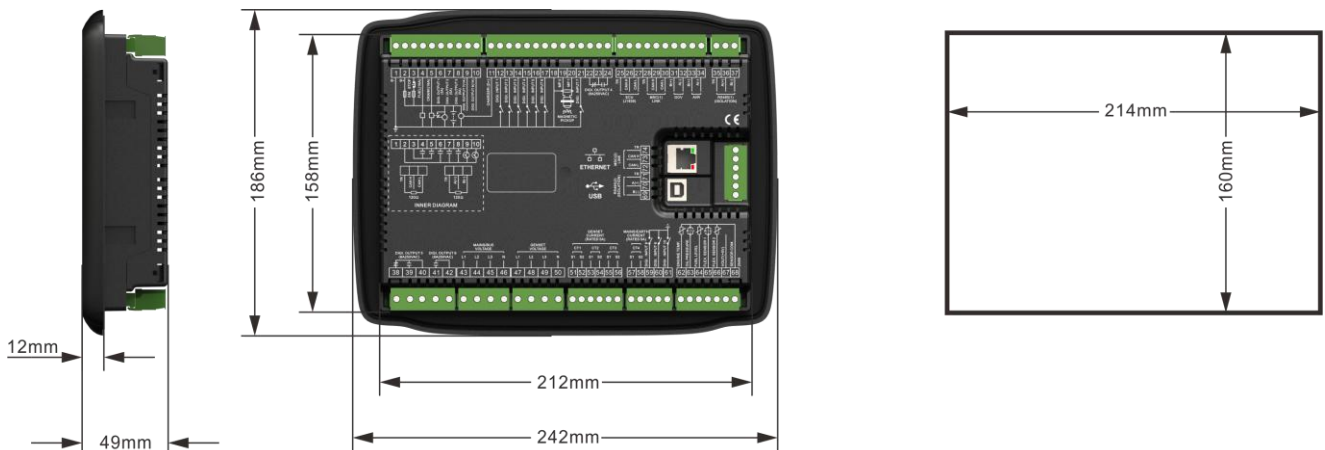

**Fig. 15 Dimension and Cutout Size**

### 1) Battery Voltage Input

**NOTE:** HGM9510N/9530N controller can suit for wide range of battery voltage (8~35) VDC. Battery negative electrode must be connected with the starter shell stably. The wire area connecting controller power B+/B- with negative and positive electrodes must be over  $2.5\text{mm}^2$ . If floating charge is configured, please firstly connect output wires of charger to battery's positive and negative directly, and then connect wires from battery's positive and negative to controller's positive and negative input ports separately in order to prevent the charge from disturbing the controller's normal working.

### 2) Speed Sensor Input

**NOTE:** Speed sensor is the magnetic equipment installed in the engine body to detect flywheel teeth number. The wires used to connect with the controller shall be 2-core shielding wires. The shielding layer shall be connected to No. 18 terminal on the controller, and meanwhile the other terminal shall be hanging in the air. Another two signal wires shall be connected to No.19 and No.20 terminals on the controller. The output voltage of the speed sensor shall be within (1~24) VAC (effective value) in the range of full speed and 12VAC is recommended (at rated speed). As to speed sensor installation, the sensor can firstly be spun to the connection flywheel, then invert 1/3 lap, and finally tighten up the screw on the sensor.

### 3) Output And Expand Relays

**CAUTION:** All controller outputs are relay contact outputs. If the expansion relay is needed, freewheel diode (relay coils is DC) and resistor and capacitor circuit (AC) shall be added to the two ends of the relay coils in order to prevent disturbing the controller or others equipments.

### 4) Alternate Current Input

Controller current input must be connected to outside current transformer. The secondary side current of the current transformer must be 5A and at the same time current transformer phase and input voltage phase must be correct, otherwise the collected current and active power are maybe not correct.

**NOTE:** ICOM port must be connected to negative pole of battery.



**WARNING!** When there is load current, transformer's secondary side is prohibited open circuit.

### 5) Withstand Voltage Test

**CAUTION!** When controller had been installed in control panel, if need the high voltage test, please disconnect controller's all terminal connections, in order to prevent high voltage into controller and damage it.



## 22 CONNECTIONS OF CONTROLLER AND J1939 ENGINE

### 22.1 CUMMINS ISB/ISBE

**Table 22 Connector B**

Terminals of controller	Connector B	Remark
Fuel relay output	39	
Start relay output	-	Connected with starter coil directly;
Auxiliary output port 1	Expansion 30A relay; providing battery voltage for terminal 01,07,12,13;	ECU power Set output 1 as "ECU power";

**Table 23 9-Pin Connector**

Terminals of controller	9 pins connector	Remark
CAN GND	SAE J1939 shield	CAN communication shielding line(connected with ECU terminal only);
CAN(H)	SAE J1939 signal	Impedance 120Ω connecting line is recommended.
CAN(L)	SAE J1939 return	Impedance 120Ω connecting line is recommended.

Engine type: Cummins ISB.

### 22.2 CUMMINS QSL9

Suitable for CM850 engine control module.

**Table 24 50-Pin Connector**

Terminals of controller	50 pins connector	Remark
Fuel relay output	39	
Start relay output	-	Connected to starter coil directly;

**Table 25 9-Pin Connector**

Terminals of controller	9 pins connector	Remark
CAN GND	SAE J1939 shield-E	CAN communication shielding line(connected with ECU terminal only);
CAN(H)	SAE J1939 signal-C	Using impedance 120Ω connecting line;
CAN(L)	SAE J1939 return-D	Using impedance 120Ω connecting line;

Engine type: Cummins-CM850.





### 22.3 CUMMINS QSM11 (IMPORT)

It is suitable for CM570 engine control module. Engine type is QSM11 G1, QSM11 G2.

**Table 26 C1 Connector**

Terminals of controller	C1 connector	Remark
Fuel relay output	5&8	External expansion relay; on fuel output, make port 5 and port 8 of C1 connector be connected;
Start relay output	-	Connected to starter coil directly;

**Table 27 3-Pin Data Link Connector**

Terminals of controller	3 pins data link connector	Remark
CAN GND	C	CAN communication shielding line(connected with ECU terminal only);
CAN(H)	A	Using impedance 120Ω connecting line;
CAN(L)	B	Using impedance 120Ω connecting line;

Engine type: Cummins ISB.

### 22.4 CUMMINS QSX15-CM570

It is suitable for CM570 engine control module. Engine type is QSX15 etc.

**Table 28 50-Pin Connector**

Terminals of controller	50 pins connector	Remark
Fuel relay output	38	Injection switch;
Start relay output	-	Connected to starter coil directly;

**Table 29 9-Pin Connector**

Terminals of controller	9 pins connector	Remark
CAN GND	SAE J1939 shield-E	CAN communication shielding line(connected with ECU terminal only);
CAN(H)	SAE J1939 signal-C	Using impedance 120Ω connecting line;
CAN(L)	SAE J1939 return-D	Using impedance 120Ω connecting line;

Engine type: Cummins QSX15-CM570.

### 22.5 CUMMINS GCS-MODBUS

It is suitable for GCS engine control module. Use RS485-MODBUS to read information of engine. Engine types are QSX15, QST30, QSK23/45/60/78 and so on.



**Table 30 D-SUB Connector 06**

Terminals of controller	D-SUB connector 06	Remark
Fuel relay output	5&8	Outside expansion relay; on fuel output, make port 05 and 08 of connector 06 be connected.
Start relay output	-	Connected to starter coil directly;
RS485 GND	20	CAN communication shielding line(connected with ECU terminal only);
RS485+	21	Using impedance 120Ω connecting line;
RS485-	18	Using impedance 120Ω connecting line;

Engine type: Cummins QSK-MODBUS, Cummins QST-MODBUS, Cummins QSX-MODBUS.

**22.6 CUMMINS QSM11**

**Table 31 Engine OEM Connector**

Terminals of controller	OEM connector of engine	Remark
Fuel relay output	38	
Start relay output	-	Connected with starter coil directly;
CAN GND	-	CAN communication shielding line(connected with controller's this terminal only);
CAN(H)	46	Using impedance 120Ω connecting line;
CAN(L)	37	Using impedance 120Ω connecting line;

Engine type: Common J1939.

**22.7 CUMMINS QSZ13**

**Table 32 Engine OEM Connector**

Terminals of controller	OEM connector of engine	Remark
Fuel relay output	45	
Start relay output	-	Connected to starter coil directly;
Programmable output 1	16&41	Set as idling speed control; (N/C) output; by expansion relay, make 16&41 close as the controller is running.
Programmable output 2	19&41	Set as pulse speed raising control; (N/O) output; by expansion relay, make 19&41 for 1s as the controller is entering warming-up time.
CAN GND	-	CAN communication shielding line(connected with controller's this terminal only);
CAN(H)	1	Using impedance 120Ω connecting line;
CAN(L)	21	Using impedance 120Ω connecting line;

Engine type: Common J1939.



**22.8 DETROIT DIESEL DDEC III/IV**

**Table 33 Engine CAN Port**

Terminals of controller	CAN port of engine	Remark
Fuel relay output	Expansion 30A relay, proving battery voltage for ECU;	
Start relay output	-	Connected to starter coil directly;
CAN GND	-	CAN communication shielding line (connected with controller terminal only);
CAN(H)	CAN(H)	Using impedance 120Ω connecting line;
CAN(L)	CAN(L)	Using impedance 120Ω connecting line;

Engine type: Common J1939.

**22.9 DEUTZ EMR2**

**Table 34 F Connector**

Terminals of controller	F connector	Remark
Fuel relay output	Expansion 30A relay, proving battery voltage for 14; Fuse is 16A.	
Start relay output	-	Connected to starter coil directly;
-	1	Connected to battery negative;
CAN GND	-	CAN communication shielding line (connected with controller terminal only);
CAN(H)	12	Impedance 120Ω connecting line is recommended.
CAN(L)	13	Impedance 120Ω connecting line is recommended.

Engine type: Volvo EDC4.

**22.10 JOHN DEERE**

**Table 35 21-Pin Connector**

Terminals of controller	21 pins connector	Remark
Fuel relay output	G, J	
Start relay output	D	
CAN GND	-	CAN communication shielding line (connected with controller's terminal only);
CAN(H)	V	Using impedance 120Ω connecting line;
CAN(L)	U	Using impedance 120Ω connecting line;

Engine type: John Deere.



### 22.11 MTU ADEC (SMART MODULE)

Suitable for MTU engines with ADEC (ECU8) and SMART module.

**Table 36 ADEC**

Terminals of controller	ADEC (X1 port)	Remark
Fuel relay output	X1 10	X1 9 shall connect battery negative.
Start relay output	X1 34	X1 33 shall connect battery negative.

**Table 37 SMART**

Terminals of controller	SMART (X4 port)	Remark
CAN GND	X4 3	CAN communication shielding line(connected with one terminal only);
CAN(H)	X4 1	Using impedance 120Ω connecting line;
CAN(L)	X4 2	Using impedance 120Ω connecting line;

Engine type: MTU-ADEC.

### 22.12 MTU ADEC(SAM MODULE)

It is suitable for MTU engine with ADEC (ECU7) and SAM module.

**Table 38 ADEC**

Terminals of controller	ADEC (X1port)	Remark
Fuel relay output	X1 43	X1 28 shall connect negative of battery.
Start relay output	X1 37	X1 22 shall connect negative of battery.

**Table 39 SAM**

Terminals of controller	SAM (X23 port)	Remark
CAN GND	X23 3	CAN communication shielding line(connected with controller's this terminal only);
CAN(H)	X23 2	Using impedance 120Ω connecting line;
CAN(L)	X23 1	Using impedance 120Ω connecting line;

Engine type: Common J1939.

### 22.13 PERKINS

It is suitable for ADEM3/ ADEM4 engine control module. Engine type is 2306, 2506, 1106, and 2806.

**Table 40 Connector**

Terminals of controller	Connector	Remark
Fuel relay output	1,10,15,33,34	
Start relay output	-	Connected to starter coil directly;
CAN GND	-	CAN communication shielding line (connected with controller terminal only);
CAN(H)	31	Using impedance 120Ω connecting line;
CAN(L)	32	Using impedance 120Ω connecting line;

Engine type: Perkins.



## 22.14 SCANIA

It is suitable for S6 engine control module. Engine type is DC9, DC12, and DC16.

**Table 41 B1 Connector**

Terminals of controller	B1 connector	Remark
Fuel relay output	3	
Start relay output	-	Connected to starter coil directly;
CAN GND	-	CAN communication shielding line (connected with controller's terminal only);
CAN(H)	9	Using impedance 120Ω connecting line;
CAN(L)	10	Using impedance 120Ω connecting line;

Engine type: Scania.

## 22.15 VOLVO EDC3

Suitable engine control mode is TAD1240, TAD1241, and TAD1242.

**Table 42 "Stand Alone" Connector**

Terminals of controller	"Stand alone" connector	Remark
Fuel relay output	H	
Start relay output	E	
programmable output 1	P	ECU power; Set output 1 as "ECU power";

**Table 43 "Data Bus" Connector**

Terminals of controller	"Data bus" connector	Remark
CAN GND	-	CAN communication shielding line (connected with controller's terminal only);
CAN(H)	1	Using impedance 120Ω connecting line;
CAN(L)	2	Using impedance 120Ω connecting line;

Engine type: Volvo.

**▲NOTE:** When this engine type is selected, preheating time should be set to at least 3 seconds.



## 22.16 VOLVO EDC4

Suitable engine types are TD520, TAD520 (optional), TD720, TAD720 (optional), TAD721, TAD722, and TAD732.

**Table 44 Connector**

Terminals of controller	Connector	Remark
Fuel relay output	Expansion 30A relay, providing battery voltage for terminal 14. Fuse is 16A.	
Start relay output	-	Connected to starter coil directly;
	1	Connected to negative of battery;
CAN GND	-	CAN communication shielding line (connected with controller's terminal only);
CAN(H)	12	Using impedance 120Ω connecting line;
CAN(L)	13	Using impedance 120Ω connecting line;

Engine type: Volvo EDC4.

## 22.17 VOLVO-EMS2

Volvo Engine types are TAD734, TAD940, TAD941, TAD1640, TAD1641, and TAD1642.

**Table 45 Engine CAN Port**

Terminals of controller	Engine's CAN port	Remark
programmable output 1	6	ECU stop; Set output 1 "ECU stop";
Programmable output 2	5	ECU power; Set output 2 "ECU power";
	3	Power negative;
	4	Power passive;
CAN GND	-	CAN communication shielding line (connected with controller's terminal only);
CAN(H)	1(Hi)	Using impedance 120Ω connecting line;
CAN(L)	2(Lo)	Using impedance 120Ω connecting line;

Engine type: Volvo-EMS2.

**NOTE:** When this engine type is selected, preheating time should be set to at least 3 seconds.



## 22.18 YUCHAI

It is suitable for BOSCH common rail pump engine.

**Table 46 Engine 42-Pin Port**

Terminals of controller	Engine 42 pins port	Remark
Fuel relay output	1.40	Connected to engine ignition lock;
Start relay output	-	Connected to starter coil directly;
CAN GND	-	CAN communication shielding line (connected with this terminal only);
CAN(H)	1.35	Using impedance 120Ω connecting line;
CAN(L)	1.34	Using impedance 120Ω connecting line;

**Table 47 Engine 2-Pin**

Battery	Engine 2 pins	Remark
Battery negative	1	Wire diameter 2.5mm <sup>2</sup> ;
Battery positive	2	Wire diameter 2.5mm <sup>2</sup> ;

Engine type: BOSCH.

## 22.19 WEICHAH

It is suitable for Weichai BOSCH common rail pump engine.

**Table 48 Engine Port**

Terminals of controller	Engine port	Remark
Fuel relay output	1.40	Connected to engine ignition lock;
Start relay output	1.61	
CAN GND	-	CAN communication shielding line (connected to the controller at this end only);
CAN(H)	1.35	Using impedance 120Ω connecting line;
CAN(L)	1.34	Using impedance 120Ω connecting line;

Engine type: GTSC1.

**NOTE:** If there is any question of connection between controller and ECU communication, please feel free to contact SmartGen's service.



**23 FAULT FINDING**

**Table 49 Fault Finding**

Symptoms	Possible Solutions
Power on but no response for the controller	Check starting batteries; Check controller connection wirings; Check DC fuse.
Genset shutdown	Check the water/cylinder temperature is too high or not; Check the genset AC voltage; Check DC fuse.
Controller emergency stop	Check emergence stop button is correct or not; Check whether the starting battery positive is connected with the emergency stop input; Check whether there is open circuit.
Low oil pressure alarm after crank disconnect	Check the oil pressure sensor and its connections.
High water temperature alarm after crank disconnect	Check the temperature sensor and its connections.
Shutdown alarm in running	Check related switch and its connections according to the information on LCD; Check programmable inputs.
Crank disconnect failure	Check fuel circuit and its connections; Check starting batteries; Check speed sensor and its connections; Refer to engine manual.
No response for starter	Check starter connections; Check starting batteries.
Genset is running but ATS does not transfer.	Check ATS; Check the connections between ATS and controllers.
RS485 communication is abnormal.	Check connections; Check settings of COM port is correct or not; Check RS485's A and B connections is reversely connected or not; Check RS485 transfer model is damaged or not; Check communication port of PC is damaged or not.
ECU communication failure	Check the polarity of CAN high and CAN low; Check 120Ω terminal resistor is correctly connected or not; Check engine type is correctly chosen or not; Check communication port of PC is damaged or not.
ECU alarm	Get information from LCD alarm page; If there is detailed alarm information, check the engine according to the description. If not, please refer to engine manual according to SPN alarm code.