



SmartGen
ideas for power

HMC4000

MARINE GENSET CONTROLLER

USER MANUAL



SMARTGEN (ZHENGZHOU) TECHNOLOGY CO., LTD.



Chinese trademark

SmartGen English trademark

SmartGen – make your generator *smart*

SmartGen Technology Co., Ltd.

No.28 Jinsuo Road, Zhengzhou, Henan Province, China

Tel: +86-371-67988888/67981888/67992951

+86-371-67981000(overseas)

Fax: +86-371-67992952

Email: sales@smartgen.cn

Web: www.smartgen.com.cn

www.smartgen.cn

All rights reserved. No part of this publication may be reproduced in any material form (including photocopying or storing in any medium by electronic means or other) without the written permission of the copyright holder.

Applications for the copyright holder's written permission to reproduce any part of this publication should be addressed to Smartgen Technology at the address above.

Any reference to trademarked product names used within this publication is owned by their respective companies.

SmartGen Technology reserves the right to change the contents of this document without prior notice.

Software Version

Date	Version	Note
2017-08-29	1.0	Original release.
2021-10-13	1.1	Modify the IP protection level.

CONTENTS

1 OVERVIEW.....	5
2 MODEL COMPARISON.....	5
3 PERFORMANCE AND CHARACTERISTICS.....	5
4 SPECIFICATION OPERATION.....	7
5 OPERATION.....	8
6 SCREENS DISPLAY.....	9
7 CONTROLLER PANEL AND OPERATION.....	10
7.1 CONTROLLER PANEL.....	10
7.2 REMOTE START/STOP OPERATION.....	11
7.2.1. ILLUSTRATION.....	11
7.2.2. REMOTE START SEQUENCE.....	11
7.2.3. REMOTE STOP SEQUENCE.....	11
7.3 AUTO START/STOP.....	12
7.3.1. ILLUSTRATION.....	12
7.3.2. AUTO START SEQUENCE.....	12
7.3.3. AUTO STOP SEQUENCE.....	12
7.4 LOCAL START/STOP SEQUENCE.....	13
7.4.1. ILLUSTRATION.....	13
7.4.2. LOCAL START SEQUENCE.....	13
7.4.3. LOCAL STOP SEQUENCE.....	13
8 PROTECTION.....	14
8.1 WARNINGS.....	14
8.2 SHUTDOWN ALARM.....	17
9 WIRINGS CONNECTION.....	19
10 SCOPES AND DEFINITIONS OF PROGRAMMABLE PARAMETERS.....	21
9.1 CONTENTS AND SCOPES OF PARAMETERS.....	21
9.2 ENABLE DEFINITION OF PROGRAMMABLE OUTPUT PORTS 1~5.....	28
9.2.1. DEFINITION OF OUTPUT PORTS SETTING CONTENT.....	28
9.2.2. DEFINITION OF OUTPUT PORTS 1-5 FUNCTION.....	28
9.3 DEFINED CONTENTS OF CONFIGURABLE INPUT PORTS 1-5.....	31
9.3.1. DEFINITION OF INPUT PORTS SETTING CONTENT.....	31
9.3.2. DEFINITION OF INPUT PORTS 1-5 FUNCTION.....	31
9.4 SELECTION OF SENSORS.....	33
9.4.1. SENSORS SELECTION.....	33
9.4.2. TEMPERATURE CURVE LIST.....	34
9.4.3. PRESSURE CURVE LIST.....	35
9.4.4. LIQUID LEVEL CURVE LIST.....	35
9.5 CRANK DISCONNECT CONDITIONS.....	36
11 PARAMETERS SETTING.....	37
10.1 CONTROLLER PARAMETER SETTING.....	37
10.2 CONTROLLER INFORMATION.....	37
10.3 EVENT LOG.....	37



12 SENSOR SETTING.....	38
13 COMMISSIONING	39
14 TYPICAL APPLICATION.....	40
15 INSTALLATION	42
14.1 FIXING CLIPS.....	42
14.2 OVERALL DIMENSION	42
14.3 WIRE CONNECTION INSTRUCTION	42
16 CONNECTIONS OF CONTROLLER WITH J1939 ENGINE.....	43
15.1 CUMMINS ISB/ISBE	43
15.2 CUMMINS QSL9	43
15.3 CUMMINS QSM11 (import)	44
15.4 CUMMINS QSX15-CM570.....	44
15.5 CUMMINS GCS-MODBUS	44
15.6 CUMMINS QSM11	45
15.7 CUMMINS QSZ13.....	45
15.8 DETROIT DIESEL DDEC III / IV	45
15.9 DEUTZ EMR2	46
15.10JOHN DEERE	46
15.11MTU ADEC (SAM module).....	46
15.12PERKINS	47
15.13SCANIA	47
15.14VOLVO EDC3	47
15.15VOLVO EDC4	48
15.16VOLVO-EMS2.....	48
15.17Yuchai	48
15.18Weichai	49
17 FAULT FINDING	49

SmartGen

1 OVERVIEW

HMC4000N marine genset controller integrate digitization, intelligentization and network technology which are used for genset automation and monitor control system of single unit to achieve remote start/stop, data measurement, alarm protection and etc. functions. It fit with LCD display, optional languages interface (Chinese and English), and it is reliable and easy to use.

HMC4000N marine genset controller adopt micro-processor technology with precision parameters measuring, fixed value adjustment, time setting and set value adjusting and etc. All parameters can be configured from front panel or through USB interface via PC. It can be widely used in all types of marine genset control automation system with compact structure, advanced circuits, simple connections and high reliability.

2 MODEL COMPARISON

MODEL	FUNCTION							
	INPUT	OUTPUT	SENSOR	GEN	RS485	HEAD	CANBUS	REMARK
HMC4000MPU	3	6	4	•	•	•		
HMC4000CAN	3	6	4	•	•		•	
HMC4000RM	0	0	0	-	•		•	

Note:
HMC4000MPU speed is collected by head sensor.
HMC4000CAN speed is collected by J1939 CANBUS.
HMC4000RM is remote monitoring control module, and it is can remotely control HMC4000MPU or HMC4000CAN

3 PERFORMANCE AND CHARACTERISTICS

Main features as follows:

- 132x64 LCD with backlight, selectable language interface (Chinese and English), push-button operation.
- Hard-screen acrylic material been used to protect screen with great wear-resisting and scratch-resisting functions.
- Silicone panel and pushbuttons can be used in extreme temperature environment.
- Equipped with CANBUS port and can communicate with J1939 gen-set.
- RS485 communication interface can connect with remote control modules. In remote control mode, it is easy and convenient to remote control engine start/stop (local start/stop keys are deactivated) .
- With override mode: in this mode, only over speed shutdown and emergency shutdown can stop the engine.
- Suitable for 3-phase 4-wire, 3-phase 3-wire, single phase 2-wire, and 2-phase 3-wire systems with voltage 120V/240V and frequency 50Hz/60Hz;
- Collects and shows 3-phase voltage, 3-phase current, power parameter and frequency of generator.

Generator

Line voltage (Uab, Ubc, and Uca)

Phase voltage (Ua, Ub, and Uc)

Frequency Hz

Load

Current	Ia, Ib, Ic	A (unit)	
Each phase and total active power	P	kW (unit)	
Each phase and reactive power	Q		kvar (unit)
Each phase and average power factor	PF		

- Precision measure and display parameters about Engine.
 - Temp. (WT) °C/°F both be displayed
 - Oil Pressure (OP) kPa/psi/bar all be displayed
 - Fuel Temp °C/°F
 - Speed (RPM) r/min (RPM)
 - Voltage of Battery V (unit)
 - Voltage of Charger V (unit)
 - Hour count accumulation
 - Start times accumulation
 - Electric energy accumulation
- Protection: real-time monitor and control diesel generator-set running status, and any faults occur it will shutdown in time and record alarms.
- Parameter setting: parameters can be modified and stored in internal FLASH memory and cannot be lost even in case of power outage; most of them can be adjusted using front panel of the controller and also can be modified using PC via USB port.
- With multiplex input port 4 and 5. Input port 4 can be configured as discrete input port or sensor input (default as oil temperature sensor); input port 5 can be set as discrete input port or programmable sensor. It can flexible used in different occasions.
- With two programmable sensors can be configured as temperature, pressure or liquid level sensor.
- Multiple crank disconnect conditions (speed sensor, oil pressure and generator frequency) are optional.
- Widely power supply range DC(8~35)V, suitable to different starting battery voltage environment.
- All parameters used digital adjustment, instead of conventional analog modulation with normal potentiometer, more reliability and stability.
- Event log and maximum 99 event logs can be memorized.
- Waterproof security level IP65 due to rubber seal installed between the controller enclosure and panel fascia.
- Metal fixing clips enable perfect in high temperature environment.
- Modular design, anti-flaming ABS plastic enclosure, pluggable connection terminals and embedded installation way; compact structure with easy mounting.









4 SPECIFICATION OPERATION

Technical Parameters

Items	Contents
Operating Voltage	DC8.0V to DC35.0V, Continuous Power Supply.
Power Consumption	<3W (standby \leq 2W)
Alternator Volt Input Range 3Phase 4Wire 3Phase 3Wire Single Phase 2Wire 2Phase 3Wire	AC15V-AC 360V (ph-N) AC30V - AC620V (ph-ph) AC15V - AC360V (ph-N) AC15V - AC360V (ph-N)
Alternator Frequency	50 Hz /60Hz
Speed sensor voltage	1.0V to 24.0V (RMS)
Speed sensor Frequency	10,000 Hz (max.)
Start Relay Output	5 A DC28V at supply output
Fuel Relay Output	5 A DC28V at supply output
Programmable Relay Output (1)	1 A DC28V at supply output
Programmable Relay Output (2)	1 A DC28V at supply output
Programmable Relay Output (3)	1A DC28V at supply output
Programmable Relay Output (4)	1A DC28V at supply output
Case Dimension	135mm x 110mm x 44mm
Panel Cutout	116mm x 90mm
CT Secondary Current	5A rated
Working Conditions	Temperature: (-25~+70)°C; Humidity: (20~93)%RH
Storage Condition	Temperature: (-25~+70)°C
Protection Level	Front panel IP65
Insulating Intensity	Apply AC2.2kV voltage between high voltage terminal and low voltage terminal; The leakage current is not more than 3mA within 1min.
Net Weight	0.32kg

5 OPERATION

Key Function Descriptions

Icons	Function	Description
	Stop	Stop running generator in local mode; During stopping process, press this button again to stop generator immediately. When generator-set is at rest, pressing and holding the button for 3 seconds will test indicator lights (lamp test);
	Start	In local mode, press this button will start generator-set.
	Remote Control	After power up, controller enters local mode as default, and press this key will set the module into remote control mode (indicator besides the key lights on). Re-press this key to back to local mode (indicator besides the key lights off).
	Self-Check	Pressing this key when generator-set is at rest, LCD will auto scroll the screen to display sensor data and alarm information, and test alarms on an occasion of no speed.
	Alarm Reset	Press this key to reset alarms.
	Set/Confirm	Pressing this key will enter into Main Menu; In setting parameter status, press this key will shift cursor or confirm setting value.
	Up/Increase	Scrolls the screen up; Shift the cursor up or increase the set value in parameter setting menu.
	Down/Decrease	Scrolls the screen down; Shift the cursor down or decrease the set value in parameter setting menu.

6 SCREENS DISPLAY

1 st Screen	Description
Generator is running screen display	
	Engine speed, generator-set UA/UAB voltage
	Oil pressure, Load power
	Engine status
Generator is at rest screen display	
	Engine speed, water temperature
	Oil pressure, power supply voltage
	Engine status
2 nd Screen	Description
Temp 35°C Power 24.5V	Engine water temperature, controller power supply
Oil Temp 20°C D+ 24.5V	Engine oil temperature, charger voltage
Total Running Time 10.2h	Engine total running time
Total Start Times 5 Local Mode	Engine start attempts, controller currently mode
3 rd Screen	Description
UL-L 400 400 400 V	Wire voltage: Uab, Ubc, Uca
UL-N 230 230 230 V	Phase voltage: Ua, Ub, Uc
I 500 500 500 A	Load current: IA, IB, IC
P 345 kW Q 0 kvar	Load active power, load reactive power
Pf 1.00 50.0 Hz	Power factor, frequency
4 th Screen	Description
P(kW) Q(kvar) S(kvA)	Active power, reactive power, apparent power display
A: 115 0 115	A-phase kW, A-phase kvar, A-phase kvA
B: 115 0 115	B-phase kW, B-phase kvar, B-phase kvA
C: 115 0 115	C-phase kW, C-phase kvar, C-phase kvA
PF 1.00 1.00 1.00	A-phase power factor, A-phase power factor, A-phase power factor
5 th Screen	Description
Total kWh: 0kWh	Accumulated active electric energy
Total kvarh 0kvarh	Accumulated reactive electric energy
6 th Screen	Description
I: 1 2 3 4 5	Input port name
	Input port status

	Output port name
	Output port status
	system present time
7 th Screen	Description
Warning Alarm Generator Under Volt.	Alarm type
	Alarm name
Remark: if there is no electric parameters display, the 3 rd , 4 th , and 5 th screen will be shielded automatically.	

7 CONTROLLER PANEL AND OPERATION

7.1 CONTROLLER PANEL



HMC4000 Front Panel Indication

NOTE: Part of indicator lights illustration:

Alarm Indicators: slowly flash when warning alarms occurred; fast flash when shutdown alarms occurred; light is off when there are no alarms.

Status Indicators: Light is off when gen-set is standby; flash once per second during start up or shut down; always on when normal running.

7.2 REMOTE START/STOP OPERATION

7.2.1. ILLUSTRATION

Press , its indicator lights, controller enters **Remote Control Mode**. After remote control mode is active, users can remotely start/stop engine by operating the controller HMC4000RM or via inputs (remote start input and remote stop input) to control engine start/stop.

7.2.2. REMOTE START SEQUENCE

- When remote start command is active or “Remote Start” input is active, “Start Delay” timer is initiated;
- “Start Delay” countdown will be displayed on LCD;
- When start delay is over, preheat relay energizes (if configured), “preheat delay XX s” information will be displayed on LCD;
- After the above delay, the Fuel Relay is energized, and then one second later, the Start Relay is engaged. Genset is cranked for a pre-set time. If genset fails to fire during this cranking attempt then the fuel relay and start relay are disengaged for the pre-set rest period; “crank rest time” begins and wait for the next crank attempt.
- Should this start sequence continue beyond the set number of attempts, the start sequence will be terminated, and Fail to Start fault alarm will be displayed on the alarm page of LCD.
- In case of successful crank attempt, the “Safety On” timer is activated. As soon as this delay is over, “start idle” delay is initiated (if configured).
- After the start idle, the controller will enter into hi-speed “Warming Up” delay (if configured).

7.2.3. REMOTE STOP SEQUENCE

- When the remote stop command is active or “Remote Stop” input signal is active, the Stop Delay is initiated.
- Once this “stop delay” has expired, controller hi-speed “Cooling” delay is energized.
- Once “Cooling” delay has expired, the “Stop Idle” is initiated (if configured). During “Stop Idle” Delay, idle relay is energized.
- Once this “Stop Idle” has expired, the “ETS Solenoid Hold” begins. ETS relay is energized while fuel relay is de-energized.
- Once this “ETS Solenoid Hold” has expired, the “Fail to Stop Delay” begins. Complete stop is detected automatically.
- Generator is placed into its standby mode after its complete stop. Otherwise, fail to stop alarm is initiated and the corresponding alarm information is displayed on LCD (If generator is stop successfully after “fail to stop” alarm has initiated, it will enter into engine standby status).

▲NOTE: there is no stop delay while stopping the remote monitoring controller.

7.3 AUTO START/STOP

7.3.1. ILLUSTRATION

Set any programmable input as “Auto Mode Input”, after it is active, controller will enter into auto mode.

7.3.2. AUTO START SEQUENCE

- When “Start/ Stop” input is active, “Start Delay” is initiated.
- “Start Delay” countdown information will be displayed on LCD.
- After the “Start Delay” has expired, preheat relay energizes (if configured), “preheat delay XX s” information will be displayed on LCD;
- After the above delay, the Fuel Relay is energized, and then one second later, the Start Relay is engaged. If the genset fails to fire during this cranking attempt then the fuel relay and start relay are disengaged for the pre-set rest period; “crank rest time” begins and wait for the next crank attempt.
- Should this start sequence continue beyond the set number of attempts, the start sequence will be terminated, and Fail to Start fault alarm will be displayed on the alarm page of LCD.
- In case of successful crank attempt, the “Safety On” timer is activated. As soon as this delay is over, “start idle” delay is initiated (if configured).
- When the “start idle” delay is over, “warming up” delay is initiated (if configured).
- When “warming up” delay is over, generator will enter into Normal Running status.

7.3.3. AUTO STOP SEQUENCE

- When “Start/Stop” input is deactivated, the “Stop Delay” is initiated.
- Once the “Stop Delay” has expired, the “Cooling Delay” is then initiated.
- Once the “Cooling Delay” has expired, the “Stop Idle” delay is initiated (if configured). During “Stop Idle” Delay, idle relay is energized.
- Once the “Stop Idle” delay has expired, “ETS Solenoid Hold” begins. ETS relay is energized while fuel relay is de-energized.
- Once this “ETS Solenoid Hold” has expired, the “Fail to Stop Delay” begins. Complete stop is detected automatically.
- Generator is placed into its standby mode after its complete stop. Otherwise, fail to stop alarm is initiated and the corresponding alarm information is displayed on LCD (If generator is stop successfully after “fail to stop” alarm has initiated, “After stop” delay will be initiated and the alarm will be removed).

7.4 LOCAL START/STOP SEQUENCE

7.4.1. ILLUSTRATION

If controller currently stays in remote control status, press  will enter into local mode, and after local mode is active, users can start/stop engine according to the buttons on the front panel of the controller.

7.4.2. LOCAL START SEQUENCE

- Pressing  to make preheat relay energized (if configured), “preheat delay XX s” information will be displayed on LCD;
- After the above delay, the Fuel Relay is energized, and then one second later, the Start Relay is engaged. If the genset fails to fire during this cranking attempt then the fuel relay and start relay are disengaged for the pre-set rest period; “crank rest time” begins and wait for the next crank attempt.
- Should this start sequence continue beyond the set number of attempts, the start sequence will be terminated, and Fail to Start fault alarm will be displayed on the alarm page of LCD.
- In case of successful crank attempt, the “Safety On” timer is activated. As soon as this delay is over, generator will enter into Normal Running status if speed, water temperature, and oil pressure are normal.

7.4.3. LOCAL STOP SEQUENCE

- 1) Pressing  to make “ETS Solenoid Hold” begins. ETS relay is energized while fuel relay is de-energized.
- 2) Once this “ETS Solenoid Hold” has expired, the “Wait for Stop” begins. Complete stop is detected automatically.
- 3) Generator is placed into its standby mode after its complete stop. Otherwise, fail to stop alarm is initiated and the corresponding alarm information is displayed on LCD (If generator is stop successfully after “fail to stop” alarm has initiated, it will enter into engine standby status).

HMC4000 Start/Stop illustration table is as follows,

System Mode	Input Start	Input Stop	Input Start/Stop	Remote Start	Remote Stop	Start Key	Stop Key
Local Mode	-	-	-	-	-	●	●
Remote Control Mode	●	●	-	●	●	-	-
Auto Mode	-	-	●	-	-	-	-

8 PROTECTION

8.1 WARNINGS

When controller detects the warning signals, alarm only and not stops the genset, the LCD displays the warning information.

No.	Type	Description
1	High Temperature	When the controller detects that engine temperature has exceeded the pre-set value, it will initiate a warning alarm and the corresponding alarm information will be displayed on LCD.
2	Low Oil Pressure	When the controller detects that the oil pressure has fallen below the pre-set value, it will initiate a warning alarm and the corresponding alarm information will be displayed on LCD.
3	Over Speed	When the speed collected by the speed sensor has exceeded the pre-set value, it will initiate a warning alarm and the corresponding alarm information will be displayed on LCD.
4	Under Speed	When the speed collected by the speed sensor has fallen below the pre-set value, it will initiate a warning alarm and the corresponding alarm information will be displayed on LCD.
5	Loss Of Speed Signal	When the controller detects that the engine speed is 0 and the delay is 0, it will initiate a warning alarm and the corresponding alarm information will be displayed on LCD.
6	Charge Alt Failure	When the controller detects that charger voltage has fallen below the battery voltage and the difference value exceed pre-set charging voltage difference value, it will initiate a warning alarm and the corresponding alarm information will be displayed on LCD.
7	Fail to Start	Engine failed to start if start attempts have been beyond pre-set start times, it will initiate a warning alarm and the corresponding alarm information will be displayed on LCD.
8	Fail to Stop	After "fail to stop" delay/ ETS delay has expired, if gen-set does not stop completely, it will initiate a warning alarm and the corresponding alarm information will be displayed on LCD.
9	Power Over Voltage	When the controller detects that battery voltage has exceeded the pre-set value, it will initiate a warning alarm and the corresponding alarm information will be displayed on LCD.
10	Power Under Voltage	When the controller detects that battery voltage has fallen below the pre-set value, it will initiate a warning alarm and the corresponding alarm information will be displayed on LCD.
11	HMC4000RM Communication Fail	When the controller detects that fail to communication with HMC4000RM, it will initiate a warning alarm and the corresponding alarm information will be displayed on LCD.



No.	Type	Description
12	ECU Warning	When controller gets the warning signals from engine via J1939, it will send warning signals and the corresponding alarm information will be displayed on LCD.
13	Low Water Pressure	When any one input set as Low Water Pressure Input and after this input is active, it will send warning signals and the corresponding alarm information will be displayed on LCD.
14	Low Water Level	When any one input set as Low Water Level Input and after this input is active, it will send warning signals and the corresponding alarm information will be displayed on LCD.
15	Low Lub Oil Level	When any one input set as Low Oil Level Input and after this input is active, it will send warning signals and the corresponding alarm information will be displayed on LCD.
16	Fuel Leakage	When any one input set as Fuel leakage Input and after this input is active, it will send warning signals and the corresponding alarm information will be displayed on LCD.
17	Temp. Sensor Open Circuit	After water temperature sensor is open circuit, it will send warning signals and the corresponding alarm information will be displayed on LCD.
18	Oil Pressure Sensor Open Circuit	After oil pressure sensor is open circuit, it will send warning signals and the corresponding alarm information will be displayed on LCD.
19	Sensor 1 Open Circuit	When sensor1 is open circuit, it will send warning signals and the corresponding alarm information will be displayed on LCD.(the name of "Senor 1" can be changed on PC software, default as "Oil Temperature")
20	Sensor 1 High	When the data collected by the sensor 1 has exceeded the pre-set sensor1 high warning alarm value, it will send warning signals and the corresponding alarm information will be displayed on LCD. (the name of "Senor 1" can be changed on PC software, default as "Oil Temperature")
21	Sensor 1 Low	When the data collected by the sensor 1 has fallen below the pre-set sensor1 low warning alarm value, it will send warning signals and the corresponding alarm information will be displayed on LCD. (the name of "Senor 1" can be changed on PC software, default as "Oil Temperature")
22	Sensor 2 Open Circuit	When sensor 2 is open circuit, it will send warning signals and the corresponding alarm information will be displayed on LCD.(the name of "Senor 2" can be changed on PC software)
23	Sensor 2 High	When the data collected by the sensor 2 has exceeded the pre-set sensor2 high warning alarm value, it will send warning signals and the corresponding alarm information will be displayed on LCD. (the name of "Senor 2" can be changed on PC software)
24	Sensor 2 Low	When the data collected by the sensor 2 has fallen below the pre-set sensor 2 low warning alarm value, it will send warning signals and the corresponding alarm information will be displayed on LCD. (the name of "Senor 2" can be changed on PC software)



No.	Type	Description
25	Input 1 Warning	When input 1 configured as warning input and input is active, it will send warning signals and the corresponding alarm information will be displayed on LCD. (the name of "Input 1" can be changed on PC software)
26	Input 2 Warning	When input 2 configured as warning input and input is active, it will send warning signals and the corresponding alarm information will be displayed on LCD. (the name of "Input 2" can be changed on PC software)
27	Input 3 Warning	When input 3 configured as warning input and input is active, it will send warning signals and the corresponding alarm information will be displayed on LCD. (the name of "Input 3" can be changed on PC software)
28	Input 4 Warning	When input 4 configured as warning input and input is active, it will send warning signals and the corresponding alarm information will be displayed on LCD. (the name of "Input 4" can be changed on PC software)
29	Input 5 Warning	When input 5 configured as warning input and input is active, it will send warning signals and the corresponding alarm information will be displayed on LCD. (the name of "Input 5" can be changed on PC software)
30	Generator Over Voltage	When the controller detects that the genset voltage has exceeded the pre-set value, it will initiate a warning alarm and the corresponding alarm information will be displayed on LCD.
31	Generator Under Voltage	When the controller detects that the genset voltage has fallen below the pre-set value, it will initiate a warning alarm and the corresponding alarm information will be displayed on LCD.
32	Generator Over Frequency	When the controller detects that the genset frequency has exceeded the pre-set value, it will initiate a warning alarm and the corresponding alarm information will be displayed on LCD.
33	Generator Under Frequency	When the controller detects that the genset frequency has fallen below the pre-set value, it will initiate a warning alarm and the corresponding alarm information will be displayed on LCD.
34	Generator Over Current	When the controller detects that the genset current has exceeded the pre-set value, it will initiate a warning alarm and the corresponding alarm information will be displayed on LCD.
35	Over Power	When the controller detects that the power (power is positive) has exceeded the pre-set value and action selected "Warning", it will initiate a warning alarm and the corresponding alarm information will be displayed on LCD.



8.2 SHUTDOWN ALARM

When controller detects shutdown alarm, it will send signals to stop the generator and the corresponding alarm information will be displayed on LCD.

No.	Type	Description
1	Emergency Stop	When controller detects emergency stop signals, it will send stop signals and the corresponding alarm information will be displayed on LCD.
2	Over Speed	When controller detects the speed value is higher than the set value, it will send stop signals and the corresponding alarm information will be displayed on LCD.
3	Under Speed	When controller detects the speed value is lower than the set value, it will send stop signals and the corresponding alarm information will be displayed on LCD.
4	Loss Of Speed Signal	When controller detects speed value equals to 0, and delay value isn't 0 (action select "Shutdown"), it will send stop signals and the corresponding alarm information will be displayed on LCD.
5	Over Frequency	When controller detects the frequency value is higher than the set value, it will send stop signals and the corresponding alarm information will be displayed on LCD.
6	Under Frequency	When controller detects the frequency value is lower than the set value, it will send stop signals and the corresponding alarm information will be displayed on LCD.
7	Over Voltage	When controller detects the voltage value is higher than the set value, it will send stop signals and the corresponding alarm information will be displayed on LCD.
8	Under Voltage	When controller detects the voltage value is lower than the set value, it will send stop signals and the corresponding alarm information will be displayed on LCD.
9	Over Current	When controller detects the current value of genset is higher than the set value and the delay value is not 0, it will send stop signals and the corresponding alarm information will be displayed on LCD.
10	High Temp. Shutdown Input	When any one input set as high water temperature shutdown and the input is active, it will send stop signals and the corresponding alarm information will be displayed on LCD.
11	Low Oil Pressure Input	When any one input set as low oil pressure shutdown and the input is active, it will send stop signals and the corresponding alarm information will be displayed on LCD.
12	High Temp. Shutdown	When temperature value collected by the temperature sensor is higher than the set value, it will send stop signals and the corresponding alarm information will be displayed on LCD.
13	Low Oil Pressure	When oil pressure value collected by the oil pressure sensor is lower than the set value, it will send stop signals and the corresponding alarm information will be displayed on LCD.
14	Sensor 1 High	When the data collected by the sensor 1 has exceeded the pre-set value, it will send stop signals and the corresponding alarm information will be displayed on LCD. (the name of "Sensor 1" can be changed on PC software,



No.	Type	Description
		default as "Water Temperature)
15	Sensor 1 Low	When the data collected by the sensor 1 has fallen below the pre-set value, it will send stop signals and the corresponding alarm information will be displayed on LCD. (the name of "Senor 1" can be changed on PC software, default as "Water Temperature)
16	Sensor 2 High	When the data collected by the sensor 2 has exceeded the pre-set value, it will send stop signals and the corresponding alarm information will be displayed on LCD. (the name of "Senor 2" can be changed on PC software)
17	Sensor 2 Low	When the data collected by the sensor 2 has fallen below the pre-set value, it will send stop signals and the corresponding alarm information will be displayed on LCD. (the name of "Senor 2" can be changed on PC software)
18	Input 1 Shutdown	When input 1 configured as shutdown input and input is active, it will send stop signals and the corresponding alarm information will be displayed on LCD. (the name of "Input 1" can be changed on PC software)
19	Input 2 Shutdown	When input 2 configured as shutdown input and input is active, it will send stop signals and the corresponding alarm information will be displayed on LCD. (the name of "Input 2" can be changed on PC software)
20	Input 3 Shutdown	When input 3 configured as shutdown input and input is active, it will send stop signals and the corresponding alarm information will be displayed on LCD. (the name of "Input 3" can be changed on PC software)
21	Input 4 Shutdown	When input 4 configured as shutdown input and input is active, it will send stop signals and the corresponding alarm information will be displayed on LCD. (the name of "Input 4" can be changed on PC software)
22	Input 5 Shutdown	When input 5 configured as shutdown input and input is active, it will send stop signals and the corresponding alarm information will be displayed on LCD. (the name of "Input 5" can be changed on PC software)
23	Over Power	When the controller detects that the power (power is positive) has exceeded the pre-set value and action selected "Shutdown", it will initiate a stop alarm and the corresponding alarm information will be displayed on LCD.
24	ECU Shutdown	When controller gets the shutdown signals from engine via J1939, it will send stop signals and the corresponding alarm information will be displayed on LCD.
25	ECU Communication Fail	After controller engine started up, it doesn't receive any data via J1939, and then it will send stop signals and the corresponding alarm information will be displayed on LCD.

 **NOTE:** ECU warning and shutdown alarms illustration, if there are detailed alarms display, controller will check engine based on the content. Otherwise, please look up engine Manual to get the information based on the SPN code.

9 WIRINGS CONNECTION

HMC4000 controller back panel is as follows:

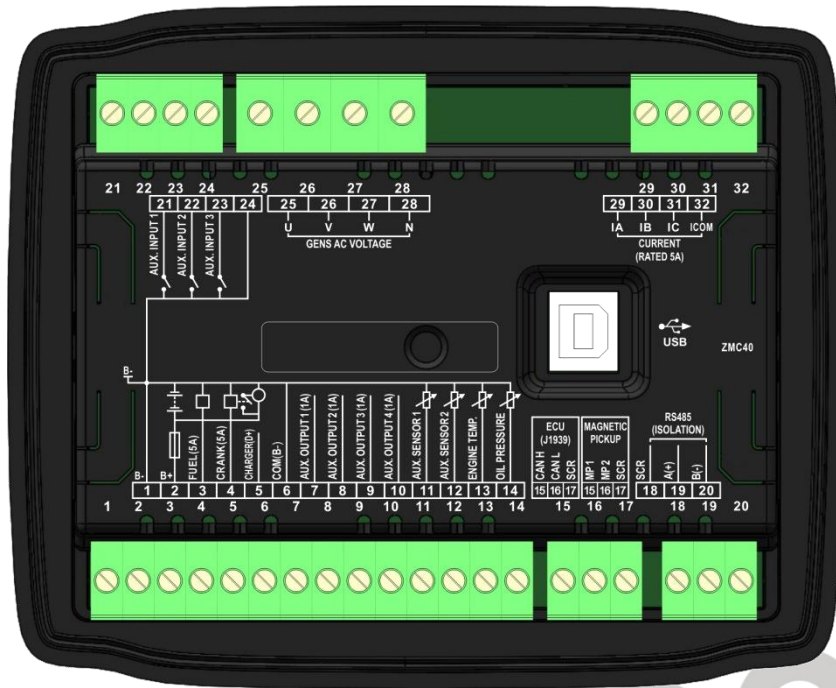

HMC4000 Back Panel

Terminal Wiring Connection

No.	Function	Cable Size	Remarks
1	B-	2.5mm ²	Connected with negative of starter battery
2	B+	2.5mm ²	Connected with positive of starter battery. If wire length is over 30m, better to double wires in parallel. Max. 20A fuse is recommended.
3	Fuel relay output	1.5mm ²	B+ is supplied by 2 terminal, rated 5A Parameter set as "programmable relay output 5".
4	Start relay output	1.5mm ²	B+ is supplied by 2 terminal, rated 5A
5	Charger(D+)	1.0mm ²	Connected with charger starter's D+ (WL) terminals. Being hang up If there is no this terminal.
6	Common ground	1.5 mm ²	Inside connect to B-.
7	Aux. Output 1	1.0mm ²	B+ is supplied by No.2 terminal, rated 1A
8	Aux. Output 2	1.0mm ²	B+ is supplied by No.2 terminal, rated 1A
9	Aux. Output 3	1.0mm ²	B+ is supplied by No.2 terminal, rated 1A
10	Aux. Output 4	1.0 mm ²	B+ is supplied by No.2 terminal, rated 1A
11	Aux. Input 1	1.0mm ²	Used as liquid level sensor or digital input port 4

Details see **10.2.2**



No.	Function	Cable Size	Remarks
12	Aux. Input 2	1.0mm ²	Used as programmable sensor or digital input port 5
13	Temperature sensor	1.0mm ²	Connected with water temperature or cylinder temperature resistor type sensor. Details see 10.4.2
14	Oil pressure sensor	1.0mm ²	Connected with oil pressure resistor type sensor. Details see 10.4.3
15	CAN H	0.5mm ²	Controller connected with CAN BUS(if with CAN BUS function); Controller connected with speed sensor(if with no CAN BUS function); Shielding line is recommended.
16	CAN L	0.5mm ²	
17	CAN Common ground	0.5mm ²	
18	RS485 Common ground	/	Impedance-120Ω shielding wire is recommended, its single-end earthed. These ports are used for connecting with HMC4000RM remote monitoring controller.
19	RS485+	0.5mm ²	
20	RS485-	0.5mm ²	
21	Aux. input 1	1.0mm ²	Ground connected is active (B-)
22	Aux. input 2	1.0mm ²	Ground connected is active (B-)
23	Aux. input 3	1.0mm ²	Ground connected is active (B-)
24	Input common port	1.0mm ²	Inside connected to B-
25	Genset U-phase voltage monitoring input	1.0mm ²	Connected to U-phase output of genset (2A fuse recommended).
26	Genset V-phase voltage monitoring input	1.0mm ²	Connected to V-phase output of genset (2A fuse recommended).
27	Genset W-phase voltage monitoring input	1.0mm ²	Connected to W-phase output of genset (2A fuse recommended).
28	Genset line N input	1.0mm ²	Connected to N-wire output of genset.
29	CT A-phase monitoring input	1.5mm ²	Outside connected to secondary coil of CT (5A rated).
30	CT B-phase monitoring input	1.5mm ²	Outside connected to secondary coil of CT (5A rated).
31	CT C-phase monitoring input	1.5mm ²	Outside connected to secondary coil of CT (5A rated).
32	CT common port	1.5mm ²	Reference to <u>Installation Instruction</u>

NOTE: USB ports in controller rear panel are programmable parameter ports, user can directly configure controller via PC.

10 SCOPES AND DEFINITIONS OF PROGRAMMABLE PARAMETERS

10.1 CONTENTS AND SCOPES OF PARAMETERS

Parameters Settings and Scope

No	Items	Range	Default	Description
Timers				
1	Start Delay	(0-3600)s	1	Time from remote start signal is active to genset start.
2	Stop Delay	(0-3600)s	1	Time from remote stop signal is active to genset stop.
3	Pre-heating Delay	(0-300)s	0	Power-on time of heater plug before starter is powered up.
4	Crank Time	(3-60)s	8	Power-on time of starter
5	Crank Rest Time	(3-60)s	10	The waiting time before second power up when engine start fail.
6	Safe Time	(1-3600)s	10	Alarms for low oil pressure, high temperature, under speed, under frequency/voltage, charge alt failure are inactive.
7	Start Idle Time	(0-3600)s	0	Idle running time of genset when starting.
8	Warm Up Time	(0-3600)s	10	Warming time between genset switch on and high speed running.
9	Cool Time	(0-3600)s	10	Radiating time before genset stop, after it unloads.
10	Stop Idle Time	(0-3600)s	0	Idle running time when genset stop.
11	ETS Hold Time	(0-3600)s	20	Stop electromagnet's power on time when genset is stopping.
12	Wait Stop Time	(0-3600)s	0	Time between ending of genset idle delay and stopped when "ETS Hold Time" is set as 0; Time between ending of ETS hold delay and stopped when "ETS time" is not 0.
13	Start Key Confirm	(0.2-5.0) s	0.2	Time duration from press start button to engine execute start process.
14	Stop Key Confirm	(0.2-5.0) s	0.2	Time duration from press stop button to engine execute stop process.
Engine				
1	Engine Options	(0-39)	0	Conventional Generator-set
2	Flywheel Teeth	(1-300)	118	Flywheel tooth number of the engine is used for judging of starter crank disconnect conditions and inspecting of engine speed. See the installation instructions.
3	Rated Speed	(1-5999)rpm	1500	Provide standard for judging over speed, under speed and speed on load.
4	Start Times	(1-30)	3	The maximum start attempts if engine fail to start. When the set number of starts is reached, the controller will send the start failure signal.



No	Items	Range	Default	Description
5	Crank Disconnect Condition	(0-6) 0: Speed 1: Oil pressure 2: Speed+OP 3: Speed+Freq. 4: Freq.+OP 5:Speed+Freq.+OP 6: Frequency	0: Speed	There are 3 conditions of disconnecting starter with engine, which can be used separately or together. Aiming at to separating the start motor and engine as soon as possible.
6	Oil Pressure of Crank Disconnect	(10-1000)kPa	80	When oil pressure is higher than the set value, starter will be disconnected.
7	Speed of Starting Motor Disconnect	(0-200)%	25%	When engine speed is higher than the set value, starter will be disconnected.
8	Under Speed Shutdown Enabled	(0-1) 0: Disabled 1: Enabled	0: Disabled	Under speed shutdown settings
9	Under Speed Set Value	(0-200)%	85%	
10	Under Speed Warning Delay	(0-3600) s	1	
11	Under Speed Warning Enabled	(0-1) 0: Disabled 1: Enabled	1: Enabled	Under speed warning settings
12	Under Speed Set Value	(0-200)%	90%	
13	Under Speed Warning Delay	(0-3600) s	1	
14	Over Speed Shutdown Enabled	(0-1) 0: Disabled 1: Enabled	1: Enabled	Over speed shutdown settings
15	Over Speed Set Value	(0-200)%	115%	
16	Over Speed Warning Delay	(0-3600) s	1	
17	Over Speed Warning Enabled	(0-1) 0: Disabled 1: Enabled	1: Enabled	Over speed warning settings
18	Over Speed Set Value	(0-200)%	110%	
19	Over Speed Warning Delay	(0-3600) s	1	
20	Loss of Speed Delay	(0-3600) s	3	Time duration from speed was detected as 0 to action was confirmed.
21	Loss of Speed Action	(0-2) 0: Warning 1: Shutdown 2: Indication	1:Shutdown	Action that controller executed after detecting speed signal is lost.
22	Charge Fail Voltage	(0-60.0)V	16.0	When the voltage difference of B+ and



No	Items	Range	Default	Description
				charger D+ (WL) is exceed the setting value, it will initiate "Fail to Charge" alarm.
23	Battery Rated Voltage	(1-60.0)V	24.0	Provide standard for judging battery over/under voltage.
24	Battery Over Voltage Warning	(0-200)%	125%	Setting values are percentage of rated voltage.
25	Battery Under Voltage Warning	(0-200)%	75%	
26	Upper Limit Temp of Water Heating	(0-100)°C	42°C	Open when water temperature sensor' temp is higher than the setting value.
27	Lower Limit Temp of Water Heating	(0-100)°C	37°C	Close when water temperature sensor's temp is lower than the setting value.
28	Generator Poles	(2-64)	4	The poles number of generator, which can be used in generator that without speed sensor to calculate engine speed.
29	Frequency of Crank Disconnect	(10.0-30.0)Hz	14.0	If generator frequency exceeds this setting value during start process, generator-set crank successfully and starter will disconnect.
30	Fuel Pump On	(10.0-30.0)Hz	20	Fuel pump will open when the value of fuel level sensor falls below the setting point.
31	Fuel Pump Off	(0-100)%	30	Fuel pump will close when the value of fuel level sensor exceeds the setting point.
Module Configuration				
1	Language	(0-1) 0: Chinese 1: English	0: Chinese	Language selection displayed on the LCD of controller.
2	Password	(0-65535)	00318	Password to enter into parameter settings page.
3	HMC4000RM Module Enabled	(0-1)	0: Disabled	Choose "Enabled" if HMC4000RM module is need to be extended.
4	Power On Mode	(0-1) 0: Local Mode 1: Remote Mode	0: Local Mode	Operation mode after controller power-on
5	Date & Time			Controller time settings
6	Baud Rate	0-1) 0:250kbps 1:125kbps	0:250kbps	CANBUS baud rate settings
7	Module Address	(0-254)	1	Communication address of controller
Sensor				
1	Temperature Sensor (resistance input)	Details to see 10.4.		Water temperature sensor setting
2	Oil Pressure Sensor (current input)	Details to see 10.4.		Oil pressure sensor setting
3	Oil Temp. Sensor (resistance input)	Details to see 10.4.		Flexible sensor 1 setting
4	Config Sensor 1	Details to see 10.4.		Flexible sensor 2 setting



No	Items	Range	Default	Description
	(resistance input)			
Inputs Setting				
1	Input 1 Function	(0-31)	0: Not used	Details to see 10.3
2	Input 1 Active Type	(0-1)	0: Close to activate	Configure input port is close to activate or open to activate.
3	Input 2 Function	(0-31)	0: Not used	Details to see 10.3
4	Input 2 Active Type	(0-1)	0: Close to activate	Configure input port is close to activate or open to activate.
5	Input 3 Function	(0-31)	0: Not used	Details to see 10.3
6	Input 3 Active Type	(0-1)	0: Close to activate	Configure input port is close to activate or open to activate.
7	Input 4 Function	(0-31)	0: Not used	Details to see 10.3 Remark: this input only can be used when flexible sensor 1 is disabled.
8	Input 4 Active Type	(0-1)	0: Close to activate	Configure input port is close to activate or open to activate.
9	Input 5 Function	(0-31)	0: Not used	Details to see 10.3 Remark: this input only can be used when flexible sensor 2 is disabled.
10	Input 5 Active Type	(0-1)	0: Close to activate	Configure input port is close to activate or open to activate.
Outputs Setting				
1	Output 1 Function	(0-100)	0: Not used	Details to see 10.2
2	Output Type	(0-1)	0: Open	Configure output port is normally open output or normally close output.
3	Output 2 Function	(0-100)	0: Not used	Details to see 10.2
4	Output Type	(0-1)	0: Open	Configure output port is normally open output or normally close output.
5	Output 3 Function	(0-100)	0: Not used	Details to see 10.2
6	Output Type	(0-1)	0:Open	Configure output port is normally open output or normally close output.
7	Output 4 Function	(0-100)	0: Not used	Details to see 10.2
8	Output Type	(0-1)	0:Open	Configure output port is normally open output or normally close output.
9	Output 5 Function	(0-100)	15: Fuel output	Details to see 10.2 Note: this output port is fuel output
10	Output Type	(0-1)	0:Open	Configure output port is normally open output or normally close output.
Generator				
11	AC System	(0-3)	0	0: 3P4W 1: 3P3W 2: 2P3W 3: 1P2W
12	Rated Voltage	(30-30000)V	230	Provide standard for generator over/under voltage, and voltage on load (this value is transformer primary voltage). When AC supply mode is selected 3P3W, this value is line voltage; and for other



No	Items	Range	Default	Description
				selections, this value is phase voltage.
13	Voltage Transformer Enabled	(0-1) 0: Disabled 1: Enabled	0: Disabled	After PT enabled, voltage calculation based on the ratio of primary voltage and secondary voltage.
14	PT Primary Voltage	(30-30000)V	100	PT primary input voltage
15	PT Secondary Voltage	(30-1000)V	100	PT secondary output voltage
16	Over Volt Warning Enabled	(0-1) 0: Disabled 1: Enabled	Enabled	When enabled, the module begins to detect overvoltage warnings.
17	Over Volt Warning Set Value	(0-200)%	110%	When generator voltage exceeds pre-set value and warning delay is expired, generator over voltage warning alarm will be sent.
18	Over Volt Warning Delay	(0-3600)s	3s	Time duration from alarms been detected to initiate alarms.
19	Over Volt Shutdown Enabled	(0-1) 0: Disabled 1: Enabled	Enabled	When enabled, the module begins to detect overvoltage shutdown alarms.
20	Over Volt Shutdown Set Value	(0-200)%	120%	When generator voltage exceeds pre-set value and over voltage shutdown delay is expired, generator over voltage shutdown alarms will be sent.
21	Over Volt Shutdown Delay	(0-3600)s	2s	Time duration from alarms been detected to initiate alarms.
22	Under Volt Warning Enabled	(0-1) 0: Disabled 1: Enabled	Enabled	When enabled, the module begins to detect under voltage warnings.
23	Under Volt Warning Set Value	(0-200)%	84%	When generator voltage falls bellow pre-set value and warning delay is expired, generator under voltage warning alarm will be sent.
24	Under Volt Warning Delay	(0-3600)s	3s	Time duration from alarms been detected to initiate alarms.
25	Under Volt Shutdown Enabled	(0-1) 0: Disabled 1: Enabled	Enabled	When enabled, the module begins to detect under voltage shutdown alarms.
26	Under Volt Shutdown Set Value	(0-200)%	80%	When generator voltage falls bellow pre-set value and shutdown delay is expired, generator under voltage shutdown alarms will be sent.
27	Under Volt Shutdown Delay	(0-3600)s	2s	Time duration from alarms been detected to initiate alarms.
28	Loss of Phase Detection Enabled	(0-1)	1	0: Disabled 1: Enabled
29	Action	(0-1) 0: Warning 1: Shutdown	Warning	Alarm actions after phase loss
30	Delay	(0-3600)s	2	When controller detects phase loss, it will



No	Items	Range	Default	Description
				initiate corresponding alarms after alarm delay is expired.
31	Phase Sequence Wrong Detection Enabled	(0-1) 0: Disabled 1: Enabled	Disabled	Negative phase sequence detection starts after it is enabled.
32	Action	(0-1) 0: Warning 1: Shutdown	Warning	Alarm actions after negative phase sequence alarm initiated.
33	Delay	(0-3600)s	2	When negative phase sequence been detected and alarm delay is expired, corresponding alarms will be sent.
34	Rated Frequency	(10.0-75.0) Hz	50.0	Provided standard for over/under frequency and frequency on load.
35	Over Frequency Warning Enabled	(0-1) 0: Disabled 1: Enabled	Enabled	When enabled, the module begins to detect over frequency warnings.
36	Over Frequency Warning Set Value	(0-200)%	110%	When generator frequency exceeds pre-set value and warning delay is expired, generator over frequency warning alarms will be sent.
37	Over Frequency Warning Delay	(0-3600)s	3s	Time duration from alarms been detected to initiate alarms.
38	Over Frequency Shutdown Enabled	(0-1) 0: Disabled 1: Enabled	Enabled	When enabled, the module begins to detect over frequency shutdown alarms.
39	Over Frequency Shutdown Set Value	(0-200)%	114%	When generator frequency exceeds pre-set value and shutdown delay is expired, generator over frequency shutdown alarms will be sent.
40	Over Frequency Shutdown Delay	(0-3600)s	2s	Time duration from alarms been detected to initiate alarms.
41	Under Frequency Warning Enabled	(0-1) 0: Disabled 1: Enabled	Enabled	When enabled, the module begins to detect under frequency warnings.
42	Under Frequency Warning Set Value	(0-200)%	84%	When generator frequency falls bellow pre-set value and warning delay is expired, generator under frequency warning alarms will be sent.
43	Under Frequency Warning Delay	(0-3600)s	3s	Time duration from alarms been detected to initiate alarms.
44	Under Frequency Shutdown Enabled	(0-1) 0: Disabled 1: Enabled	Enabled	When enabled, the module begins to detect under frequency shutdown alarms.
45	Under Frequency Shutdown Set Value	(0-200)%	80%	When generator frequency falls bellow pre-set value and trip delay is expired, generator under frequency trip alarms will be sent.
46	Under Frequency	(0-3600)s	2s	Time duration from alarms been detected



No	Items	Range	Default	Description
	Shutdown Delay			to initiate alarms.
47	Rated Current	(5-6000)A	500	It is rated current of generator, which used as the standard for current with load.
48	Transform	(5-6000)/5	500	External connected current transformer ratio.
49	Rated Power	(0-6000)kW	276	It is rated power of generator, which used as the standard for power inspection.
50	Over Current Warning Enabled	(0-1) 0: Disabled 1: Enabled	Enabled	When enabled, the module begins to detect over current warning alarms.
51	Over Current Warning Set Value	(0-200)%	110%	When generator current exceeds pre-set value and warning delay is expired, generator over current warning alarms will be sent.
52	Over Current Warning Delay	(0-3600)s	10s	Time duration from alarms been detected to initiate alarms.
53	Over Current Shutdown Enabled	(0-1) 0: Disabled 1: Enabled	Enabled	When enabled, the module begins to detect over current shutdown alarms.
54	Over Current Shutdown Set Value	(0-200)%	114%	When generator current exceeds pre-set value and trip delay is expired, generator over current trip alarms will be sent.
55	Over Current Shutdown Delay	(0-3600)s	3s	Time duration from alarms been detected to initiate alarms.
56	Over Power Warning Enabled	(0-1) 0: Disabled 1: Enabled	Enabled	When enabled, the module begins to detect over power warning alarms.
57	Over Power Warning Set Value	(0-200)%	110%	When generator current exceeds pre-set value and warning delay is expired, generator over power warning alarms will be sent.
58	Over Power Warning Delay	(0-3600)s	3s	Time duration from alarms been detected to initiate alarms.
59	Over Power Shutdown Enabled	(0-1) 0: Disabled 1: Enabled	Enabled	When enabled, the module begins to detect over power shutdown alarms.
60	Over Power Shutdown Set Value	(0-200)%	114%	When generator current exceeds pre-set value and warning delay is expired, generator over power trip alarms will be sent.
61	Over Power Shutdown Delay	(0-3600)s	2s	Time duration from alarms been detected to initiate alarms.

10.2 ENABLE DEFINITION OF PROGRAMMABLE OUTPUT PORTS 1~5

10.2.1. DEFINITION OF OUTPUT PORTS SETTING CONTENT

Outputs settings definition

No.	Item	Setting Content	Remark
1	Outputs Function Settings	(0-100)	
2	Active Selection	0: Normally Open 1: Normally Close	
3	Active Period	Bit0: Not used Bit1: Standby Bit2: Pre-heat Bit3: Fuel Output Bit4: Crank Bit5: Crank Rest Bit6: Safety On Delay Bit7: Start Idle Bit8: Warming Up Bit9: Waiting For Loading Bit10: Normal Running Bit11: Cooling Bit12: Stop Idle Bit13: ETS Bit14: Wait for Stop Bit15: Fail to Stop	
5	Delay Output Time	(0-100.0)S	
6	Output Time	(0-3600)S	

10.2.2. DEFINITION OF OUTPUT PORTS 1-5 FUNCTION

Programmable outputs 1-5

No.	Items	Description
0	Not Used	Output port is deactivated when "Not Used" is selected.
1	Custom	Details to see 10.2.1
2	Common Alarm	Output when alarms occurred.
3	ETS Hold	Output when energize to stop.
4	Idle Control	Output when controller idle running and open in high speed running.
5	Preheat Control	Close before starting and open before power up.
6	Override Output	Output when controller in override mode.
7	Ready Go	Output when controller in standby mode and without sensor break wire alarms.
8	Reserved	Reserved
9	Raise Speed	Output when raise speed input is active.
10	Drop Speed	Output when drop speed input is active.
11	Crank Success	Output after controller crank disconnected.



No.	Items	Description
12	Fuel Pump Control	Reserved
13	Reserved	Reserved
14	Local Mode Output	Output when controller in local mode.
15	Fuel Output	Close when generator starts up and open when in stop process.
16	Excite Generator	Output while generator is cranking, and output for 2s if there is no frequency during safety on period.
17	Fuel Leak Output	Output when controller fuel leakage warning.
18	Reserved	Reserved
19	Common Shutdown	Output when controller shutdown alarms occurred.
20	Audible Alarm	Output when controller alarms occurred and press any key to mute alarms. Then disconnect after alarms mute.
21	Heater Control	Controller controls heater working based on "Heating Temperature Upper Limit" and "Heating Temperature Lower Limit"
22	Reserved	Reserved
23	Crank Output	Close when generator is cranking and open when crank disconnect.
24	ECU Stop	Used for ECU engine and control its shutdown.
25	ECU Power	Used for ECU engine and control its power.
26	ECU Warning	Indicate ECU sends a warning alarm signal.
27	ECU Shutdown	Indicate ECU sends a shutdown alarm signal.
28	ECU Communication Fail	Indicate controller not communicates with ECU.
29	Normal Running	Output after engine normally running.
30	Remote Mode Output	Output when controller in remote control mode.
31	Reserved	Reserved
32	Reserved	Reserved
33	Water Temp Sensor Open Circuit Warning	Output when controller open circuit alarms of temperature sensor occurred.
34	Water Temp High Warning	Output when water temperature is high (action select warning).
35	Water Temp High Shutdown	Output when water temperature is high (action select shutdown).
36	Oil Pressure Sensor Open Circuit Warning	Output when controller open circuit alarms of oil pressure sensor occurred.
37	Oil Pressure Low Warning	Output when oil pressure is low (action select warning).
38	Oil Pressure Low Shutdown	Output when oil pressure is low (action select shutdown).
39	Config Sensor 1 Open Circuit Warning	Output when controller open circuit alarms of flexible sensor 1 occurred.
40	Config Sensor 1 Warning	Output when flexible sensor 1 is warning.



No.	Items	Description
41	Config Sensor 1 Shutdown	Output when flexible sensor 1 is shutdown.
42	Config Sensor 2 Open Circuit Warning	Output when controller open circuit alarms of flexible sensor 2 occurred.
43	Config Sensor 2 Warning	Output when flexible sensor 2 is warning.
44	Config Sensor 2 Shutdown	Output when flexible sensor 2 is shutdown.
45	Over Volt Warning	Output when controller is over voltage warning.
46	Over Volt Shutdown	Output when controller is over voltage shutdown.
47	Under Volt Warning	Output when controller is under voltage warning.
48	Under Volt Shutdown	Output when controller is under voltage shutdown.
49	Over Frequency Warning	Output when controller is over frequency warning.
50	Over Frequency Shutdown	Output when controller is over frequency shutdown.
51	Over Current Warning	Output when controller is over current warning.
52	Over Current Shutdown	Output when controller is over current shutdown.
53	Over Power Warning	Output when controller is over power warning.
54	Over Power Shutdown	Output when controller is over power shutdown.
55	Over Speed Warning	Output when controller is over speed warning.
56	Over Speed Shutdown	Output when controller is over speed shutdown.
57	Battery Under Volt	Output when controller power supply voltage is low warning.
58	Failed to Start	Output when controller fails to start warning.
59	Failed to Stop	Output when controller fails to stop warning.
60	Emergency Stop Alarm	Output when controller is emergency stop alarm occurred.
61	Under Frequency Warning	Output when controller is under frequency warning.
62	Under Frequency Shutdown	Output when controller is under frequency shutdown.
63	Input 1 Active	Output when controller input 1 is active.
64	Input 2 Active	Output when controller input 2 is active.
65	Input 3 Active	Output when controller input 3 is active.
66	Input 4 Active	Output when controller input 4 is active.
67	Input 5 Active	Output when controller input 5 is active.
68~100	Reserved	

10.3 DEFINED CONTENTS OF CONFIGURABLE INPUT PORTS 1-5



10.3.1. DEFINITION OF INPUT PORTS SETTING CONTENT

Inputs settings definition

No.	Item	Setting Content	Remark
1	Inputs Function Settings	(0- 31)	Detail to see 10.3.2
2	Active Selection	(0-1)	0: Close to Active 1: Open to Active
3	Active Period	(0-3)	0: After Safety On Delay 1: From Start 2: Always 3: Inactive
4	Active Action	(0-2)	0: Warning 1: Alarm Shutdown 2: Indication
5	Input Delay	(0-20.0)s	
6	String Display	Name of input port can be user-defined	20 English characters or 10 Chinese characters

10.3.2. DEFINITION OF INPUT PORTS 1-5 FUNCTION

Enable Programmable Inputs 1~5 (all inputs are grounded(B-))

No	Items	Description
0	Not Used	Input port is inactive when select "Not Used"
1	Custom	
2	Water Temperature High	If input is active, shutdown alarm will be immediately initiated.
3	Oil Pressure Low	If input is active, shutdown alarm will be immediately initiated.
4	Reserved	Reserved
5	Emergency Stop	Emergency stop alarm will be initiated if this input is active.
6	Remote Mode	Controller enters remote control mode after this input is active.
7	Local Mode	Controller enters local mode after this input is active.
8	Override Mode	If input is active, all shutdown alarms except over speed shutdown alarm and emergency shutdown alarm are all unavailable.
9	Auto Mode	Controller enters auto mode after this input is active.
10	Remote Start/Stop	When this input is active in auto mode, generator-set start automatically and on load after running. Otherwise, generator-set will stop automatically if it is disconnect.
11	Reserved	Reserved
12	Water Pressure Low	Controller displayed "Low Water Pressure" after this input is active.
13	Water Level Low	Controller displayed "Low Water Level" after this input is active.
14	Lub Oil Level Low	Controller displayed "Low Oil Level" after this input is active.
15	Reserved	Reserved
16	Reserved	Reserved
17	Reserved	Reserved
18	Panel Lock	When input is active, all keys except the   buttons are



No	Items	Description
		deactivated and right of last line of home page on LCD displayed
19	Fuel Leak Warning	Controller displayed "Fuel Leakage Warning" after this input is active.
20	Alarm Mute	When input is active, "Audible Alarm" output is disconnecting.
21	Speed Up	Rise speed output port of controller outputs when this input is active.
22	Speed Down	Drop speed output port of controller outputs when this input is active.
23	Reserved	Reserved
24	Reserved	Reserved
25	60Hz Select	Used for EFI engine with CANBUS interface. When it is active, frequency is 60Hz.
26	Reserved	Reserved
27	Remote Start Input	When controller in remote control mode, generator-set starts up when this input is active.
28	Stop Input	When controller in remote control mode, generator-set stops when this input is active.
29	Reserved	
30	Turning Chain	Engine start is inhibiting after "Turning Chain" input is active.
31	Reserved	Reserved

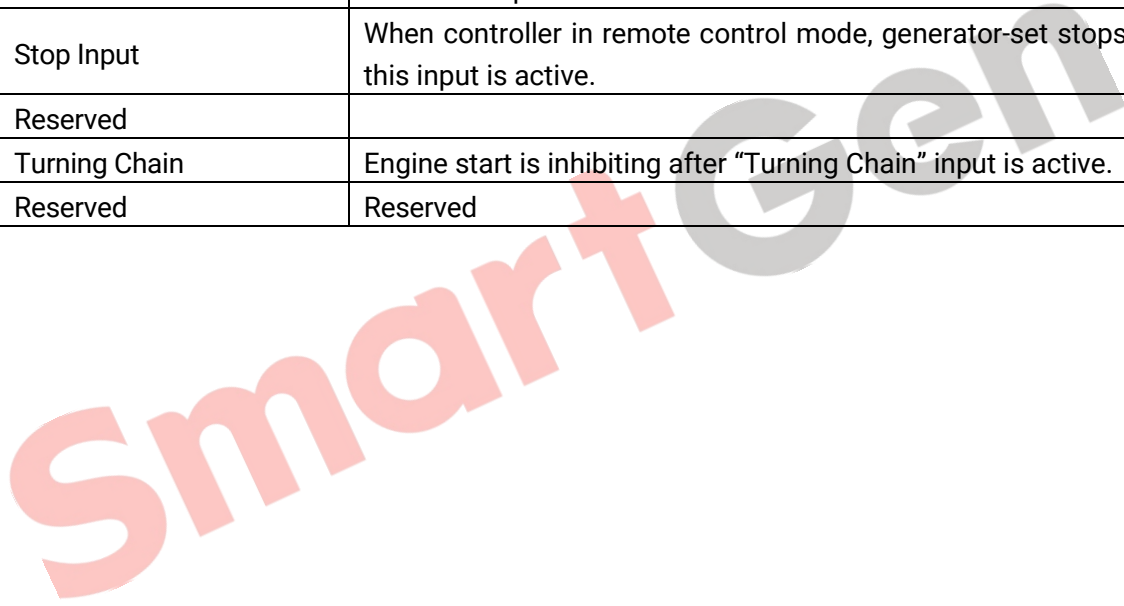

10.4 SELECTION OF SENSORS

10.4.1. SENSORS SELECTION

Sensor Selection Description

No.	Items	Description	Remark
1	Sensor Types	(0-3) 0: Not used 1: Pressure sensor 2: Temperature sensor 3: Fuel Level sensor	
2	Sensor Curve Types	Details to see the following curve type lists.	Details to see 10.4.2/10.4.3/10.4.4.
3	Speed Warning	(0-200)%	Alarm detection start when this speed is exceeded.
4	Range	(0-6000)	4~20mA sensor is active Pressure sensor unit is kPa and liquid level sensor unit is %.
5	Display Unit	Temp 0: °C 1: °F Pressure 0: kPa 1: Psi 2: bar	Unit displayed on the LCD of controller. Data will be automatically converted according to the unit.
6	Sensor Upper Limit Shutdown Enabled	(0-1) 0: Enabled 1: Disenabled	
7	Upper Limit Shutdown Value	(0-6000)	
8	Shutdown Delay	(0-3600)s	
9	Sensor lower Limit Shutdown Enabled	(0-1) 0: Enabled 1: Disenabled	
10	Lower Limit Shutdown Value	(0-4000)	
11	Shutdown Delay	(0-3600)s	
12	Sensor Upper Limit Warning Enabled	(0-1) 0: Enabled 1: Disabled	
13	Upper Limit Warning Value	(0-6000)	
14	Upper Limit Warning Return Value	(0-6000)	
15	Upper Limit Warning Delay	(0-3600)s	
16	Sensor Lower Limit Warning Enabled	(0-1) 0: Enabled 1: Disabled	
17	Lower Limit Warning Value	(0-4000)	
18	Lower Limit Warning Return Value	(0-4000)	
19	Lower Limit Warning Delay	(0-3600)s	



No.	Items	Description	Remark
20	1 st Point of X (resistor)	Resistor type (Non-PT100)	User can define sensor curves. (X-axial and Y-axial are both contain 8 points)
21	2 nd Point of X (resistor)	Resistor type (Non-PT100)	
22	3 rd Point of X (resistor)	Resistor type (Non-PT100)	
23	4 th Point of X (resistor)	Resistor type (Non-PT100)	
24	5 th Point of X (resistor)	Resistor type (Non-PT100)	
25	6 th Point of X (resistor)	Resistor type (Non-PT100)	
26	7 th Point of X (resistor)	Resistor type (Non-PT100)	
27	8 th Point of X (resistor)	Resistor type (Non-PT100)	
28	1 st Point of Y (value)	Resistor type (Non-PT100)	
29	2 nd Point of Y (value)	Resistor type (Non-PT100)	
30	3 rd Point of Y (value)	Resistor type (Non-PT100)	
31	4 th Point of Y (value)	Resistor type (Non-PT100)	
32	5 th Point of Y (value)	Resistor type (Non-PT100)	
33	6 th Point of Y (value)	Resistor type (Non-PT100)	
34	7 th Point of Y (value)	Resistor type (Non-PT100)	
35	8 th Point of Y (value)	Resistor type (Non-PT100)	
36	User-defined Strings	User can define name of sensors	Set only by PC software.

10.4.2. TEMPERATURE CURVE LIST

Temperature Curves Description

No.	Name	Remark
0	Not Used	Defined resistance's range is 0~6KΩ, default is SGX sensor (water temperature sensor and oil temperature are all PT100 sensors).
1	PT100	
2	Custom Resistance Curve	
3	VDO	
4	CURTIS	
5	VOLVO-EC	
6	DATCON	
7	SGX	
8	SGD	
9	SGH	
10	Reserved	
11	Cu50	
12	Reserved	
13	Reserved	
14	Reserved	
15	Reserved	

Note: PT100 division value of resistor type temperature sensor is fixed as 0.385 (0.385Ω correspond to 1°C)

10.4.3. PRESSURE CURVE LIST

Pressure Curves Description

No.	Name	Remark
0	Not Used	Defined resistance's range is 0~6KΩ, default oil pressure sensor is VDO-10bar.
1	4~20mA	
2	Custom Curve	
3	VDO 10bar	
4	CURTIS	
5	Reserved	
6	DATCON 10Bar	
7	SGX	
8	SGD	
9	SGH	
10	Reserved	
11	Reserved	
12	Reserved	
13	Reserved	
14	Reserved	
15	Reserved	

▲Note: if pressure signal is current-type, there is no need to set the curve and only need to set range.

10.4.4. LIQUID LEVEL CURVE LIST

Liquid Level Curves Description

No.	Name	Remark
0	Not Used	There is no liquid level sensor in HMC4000 default sensor types. If this type is need to be used, please choose one between flexible sensor 1 and flexible sensor 2.
1	4~20mA	
2	Custom Resistance Curve	
3	SGD	
4	SGH	
5	Reserved	
6	Reserved	
7	Reserved	
8	Reserved	
9	Reserved	
10	Reserved	
11	Reserved	
12	Reserved	
13	Reserved	
14	Reserved	
15	Reserved	

▲Note: if pressure signal is current-type, there is no need to set the curve and only need to set range.

10.5 CRANK DISCONNECT CONDITIONS

No.	Setting description
0	Speed
1	Oil pressure
2	Speed + Oil pressure
3	Speed +Generator frequency
4	Gen frequency + Oil pressure
5	Speed + Gen frequency + Oil pressure
6	Generator frequency

▲NOTE:

- 1) There are 3 conditions to make starter separate with engine; speed, generator frequency and oil pressure can be used separately while oil pressure suggest be used together with speed and generator frequency. The aim is to disconnect the starter motor as soon as possible.
- 2) Speed stands for the real rotation speed detected by the speed sensor. Speed sensor is the magnetic equipment which be installed in starter for detecting flywheel teeth.
- 3) When set as speed, must ensure that the number of flywheel teeth is as same as setting, otherwise, "over speed shutdown" or "under speed shutdown" may be caused.
- 4) If generator-set without speed sensor please don't select corresponding items, otherwise, "start fail" or "loss speed signal" maybe caused.
- 5) If generator-set without oil pressure sensor, please don't select corresponding items.
- 6) If not select generator frequency in crank disconnect setting, controller will not collect and display the relative power quantity (can be used in water pump set); if not select speed in crank disconnect setting, the engine speed displayed in controller is calculated by generator signal.

SmartGen

11 PARAMETERS SETTING

11.1 CONTROLLER PARAMETER SETTING

Start the controller, then press  to enter into the parameters setting menu, menu items as follows:

- 1 Return
- 2 Set Parameters
- 3 Information
- 4 Eventlog

When entered password interface, inputting correct password (default password is "0318") can set parameters. If the password is changed, only input the password same as controllers', can the parameter be set via PC software. If there is need to set more parameters (e.g. voltage calibration; current calibration), please contact the factory.

NOTES:

- a) Please change the controller parameters when generator is in standby mode only (e. g. Crank disconnect conditions selection, auxiliary input, auxiliary output, various delay), otherwise, shutdown and other abnormal conditions may occurs.
- b) Over voltage set value must be higher than under voltage set value, otherwise over voltage and under voltage condition may occur simultaneously.
- c) Over speed set value must be higher than under speed set value, otherwise over speed and under speed condition may occur simultaneously.
- d) Please set the generator frequency value as low as possible when cranking, in order to make the starter be separated quickly as soon as possible.
- e) Auxiliary input 1~5 could not be set as same items; otherwise, there are abnormal functions. However, the auxiliary output 1~5 can be set as same items.
- f) Programmable sensor 1 input port can be set as temperature sensor, pressure sensor, coolant level sensor or discrete input port 4; programmable sensor 2 input port can be set as temperature sensor, pressure sensor, coolant level sensor or discrete input port 5. Choose either sensor or discrete input port, if discrete input port be selected, corresponding set parameters be functional and sensor parameters are deactivated and reserved; otherwise, if sensor be selected, corresponding sensor parameters be functional and discrete input port parameters are deactivated and reserved.
- g) If need to shut down after cooling, please set any auxiliary input as "High Temperature Stop Input", then connect this input port to GND or set "High Temperature Stop Input" action as "Cooling Stop"

11.2 CONTROLLER INFORMATION

LCD will display develop information like software version, issue date and present date of the controller.

11.3 EVENT LOG

View event log from this interface, including start/stop information and shutdown alarm information log. It can record and display up to 99 pieces.

Event Log	Title
Shutdown Alarm	Record Type
Over Speed Shutdown	Name of Alarm
2017-08-08 15:30:25	Alarm Occurred Time

12 SENSOR SETTING

- 1) When reselect sensors, the sensor curve will be transferred into the standard value. For example, if temperature sensor is SGH (120°C resistor type), its sensor curve is SGH (120°C resistor type); if select the SGD (120°C resistor type), the temperature sensor curve is SGD curve.
- 2) When there is difference between standard sensor curves and using sensor, user can entry into "Custom Sensors" page to define sensor curve.
- 3) When input the sensor curve, X value (resistor) must be input from small to large, otherwise, mistake occurs.
- 4) The headmost or backmost values in the vertical coordinates can be set as same as below,

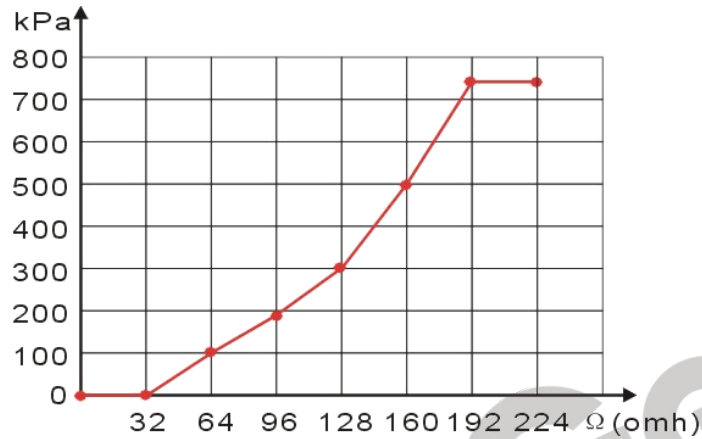

Common unit conversion table

Items	N/m ² (pa)	kgf/cm ²	bar	(p/in ² .psi)
1Pa	1	1.02x10 ⁻⁵	1x10 ⁻⁵	1.45x10 ⁻⁴
1kgf/cm ²	9.8x10 ⁴	1	0.98	14.2
1bar	1x10 ⁵	1.02	1	14.5
1psi	6.89x10 ³	7.03x10 ⁻²	6.89x10 ⁻²	1

13 COMMISSIONING

Please make sure the following checks are made before commissioning,

- 1) Ensure all the connections are correct and wires diameter is suitable.
- 2) Ensure that the controller DC power has fuse, controller's positive and negative connected to start battery are correct.
- 3) Take proper action to prevent engine to crank success (e. g. Remove the connection wire of fuel valve). If checking is OK, make the start battery power on; choose manual mode and controller will executive routine.
- 4) Set controller under local mode, press "start" button, genset will start. After the cranking times as setting, controller will send signal of Start Failure; then press "stop" to reset controller.
- 5) Recover the action to prevent engine to crank success (e. g. Connect wire of fuel valve), press start button again, genset will start. If everything goes well, genset will normal running after idle running (if idle run be set). During this time, please watch for engine's running situations and AC generator's voltage and frequency. If abnormal, stop genset and check all wires connection according to this manual.
- 6) If there is any other question, please contact SmartGen's service.

SmartGen

14 TYPICAL APPLICATION

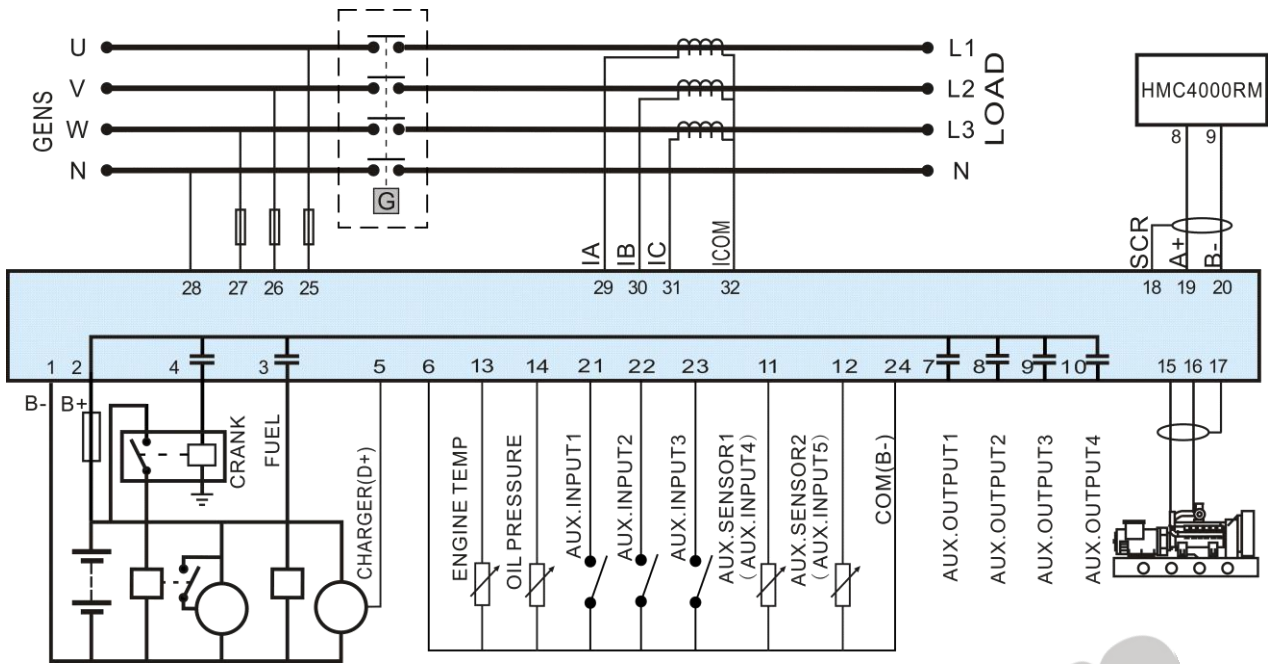

HMC4000 with Generator Typical Application (J1939 Interface)

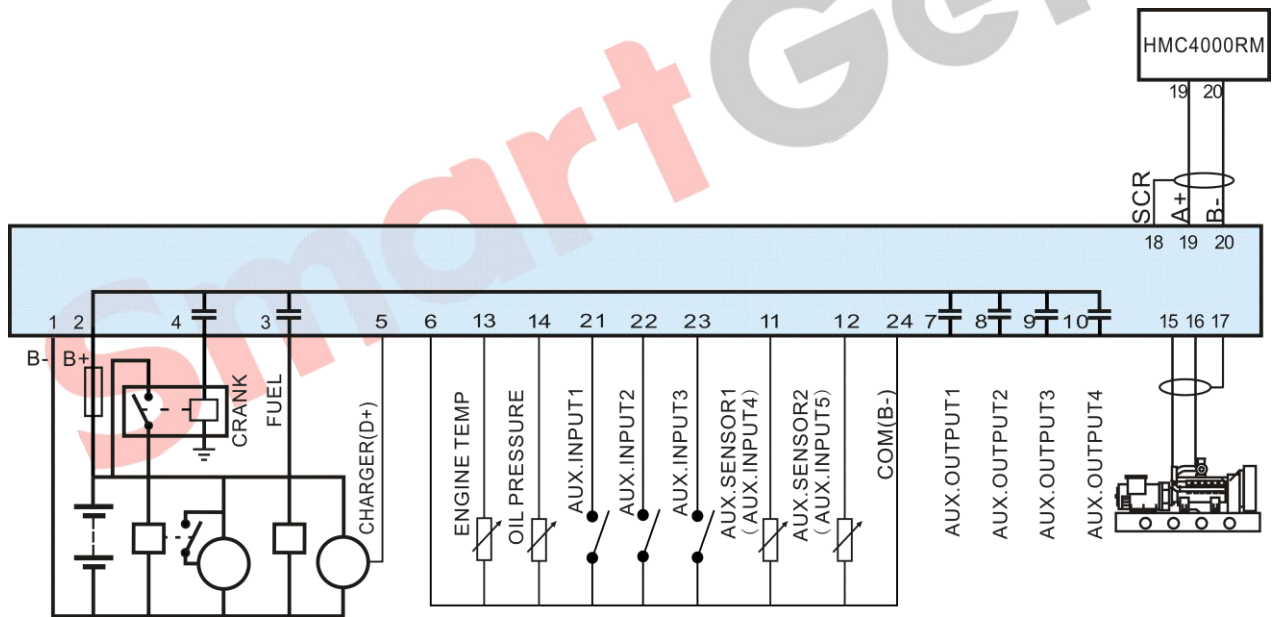

HMC4000 Monitor Typical Application (J1939 Interface)

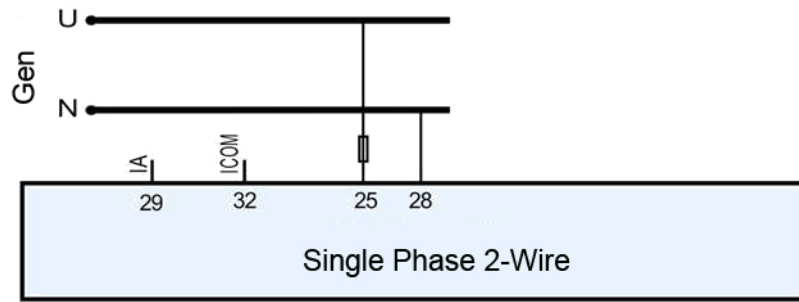

Single Phase 2-Wire Wiring Connection Diagram

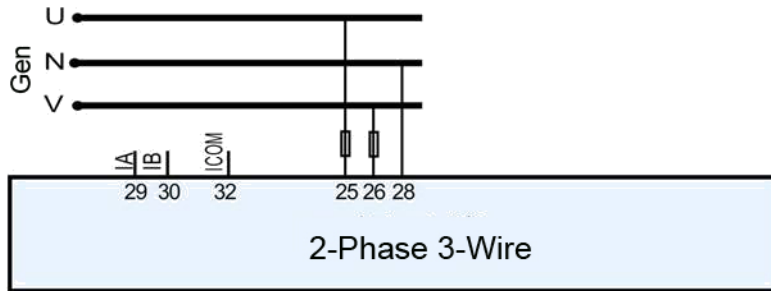

2-Phase 3-Wire Connection Diagram

▲ **Note:** Expand relay with high capacity in start and fuel output is recommend.

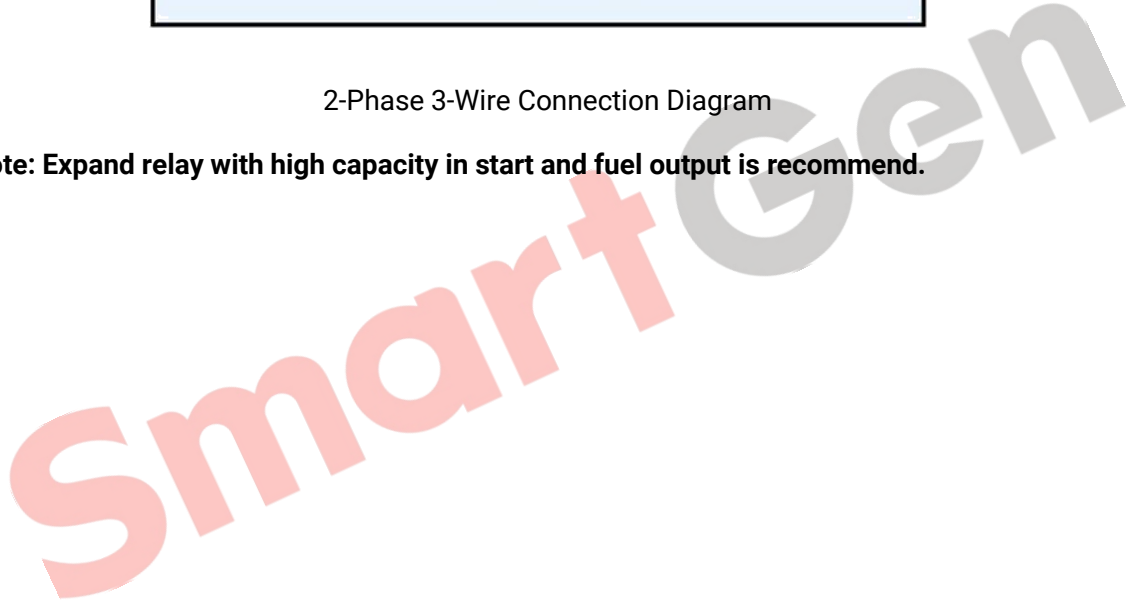

15 INSTALLATION

15.1 FIXING CLIPS

- 1) Controller is panel built-in design; it is fixed by clips when installed.
- 2) Withdraw the fixing clip screw (turn anticlockwise) until it reaches proper position.
- 3) Pull the fixing clip backwards (towards the back of the module) ensuring two clips are inside their allotted slots.
- 4) Turn the fixing clip screws clockwise until they are fixed on the panel.

▲ Note: Care should be taken not to over tighten the screws of fixing clips.

15.2 OVERALL DIMENSION

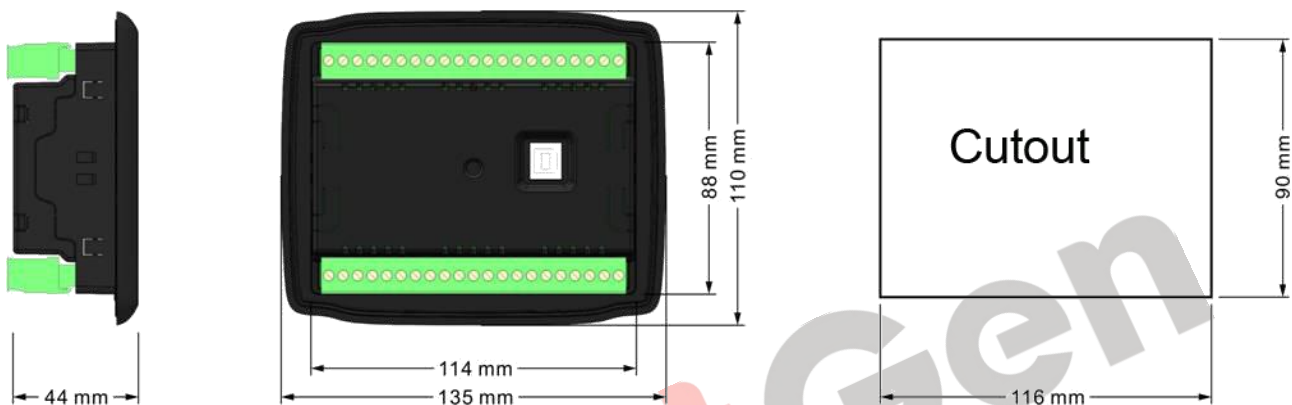

HMC4000 series controller can suit for widely range of battery voltage DC (8~35) V. Negative of battery must be connected with the engine shell. Diameter of wire that connects from power supply to battery must be over 2.5mm². If floating charge configured, please firstly connect output wires of charger to battery's positive and negative directly, then, connect wires from battery's positive and negative to controller's positive and negative input ports in order to prevent charge disturbing the controller's normal working.

15.3 WIRE CONNECTION INSTRUCTION

⚠ SPEED SENSOR INPUT

Speed sensor is the magnetic equipment which be installed in starter and for detecting flywheel teeth. Its connection wires to controller should apply for 2 cores shielding line. The shielding layer should connect to No. 17 terminal in controller while another side is hanging in air. The else two signal wires are connected to No.1 and No.17 terminals in controller. The output voltage of speed sensor should be within AC (1~24) V (effective value) during the full speed. AC12V is recommended (in rated speed). When install the speed sensor, let the sensor is spun to contacting flywheel first, then, port out 1/3 lap, and lock the nuts of sensor at last.

⚠ OUTPUT AND EXPAND RELAYS

All outputs of controller are relay contact output type. If need to expand the relays, please add freewheel diode to both ends of expand relay's coils (when coils of relay has DC current) or, increase resistance-capacitance return circuit (when coils of relay has AC current), in order to prevent disturbance to controller or others equipment.

⚠ AC INPUT

Current input of controller must be connected to outside current transformer. And the current transformer's secondary side current must be 5A. At the same time, the phases of current transformer and input voltage must correct. Otherwise, the current of collecting and active power maybe not correct.

▲NOTE:

- 1) ICOM port must be connected to negative pole of battery.
- 2) When there is load current, transformer's secondary side prohibit open circuit.

16 CONNECTIONS OF CONTROLLER WITH J1939 ENGINE

16.1 CUMMINS ISB/ISBE

Terminals of controller	Connector B	Remark
Auxiliary output port 1	39	Set configurable output 1 as "Fuel Output"
Start relay output	-	Connect with starter coil directly
Auxiliary output port 2	Expand 30A relay, battery voltage of 01,07,12,13 is supplied by relay.	ECU power Set configurable output 2 as "ECU power"

Terminals of controller	9 pins connector	Remark
CAN_SCR	SAE J1939 shield	CAN communication shielding line(connect to ECU terminal only)
CAN(H)	SAE J1939 signal	Using impedance 120Ω connecting line.
CAN(L)	SAE J1939 return	Using impedance 120Ω connecting line.

Engine type: Cummins ISB

16.2 CUMMINS QSL9

Suitable for CM850 engine control mode

Terminals of controller	50 pins connector	Remark
Auxiliary output port 1	39	Set configurable output 1 as "Fuel Output"
Start relay output	-	Connect to 34 starter coil directly

Terminals of controller	9 pins connector	Remark
CAN_SCR	SAE J1939 shield-E	CAN communication shielding line(connect to ECU terminal only)
CAN(H)	SAE J1939 signal-C	Using impedance 120Ω connecting line
CAN(L)	SAE J1939 return-D	Using impedance 120Ω connecting line

Engine type: Cummins-CM850

16.3 CUMMINS QSM11 (import)

It is suitable for CM570 engine control mode. Engine type is QSM11 G1, QSM11 G2.

Terminals of controller	C1 connector	Remark
Auxiliary output port 1	5&8	Set configurable output 1 as "Fuel Output". Outside expand relay, when fuel output, making make port 5 and port 8 of C1 be connected
Start relay output	-	Connect to starter coil directly

Terminals of controller	3 pins data link connector	Remark
CAN_SCR	C	CAN communication shielding line(connect to ECU terminal only)
CAN(H)	A	Using impedance 120Ω connecting line
CAN(L)	B	Using impedance 120Ω connecting line

Engine type: Cummins ISB

16.4 CUMMINS QSX15-CM570

It is suitable for CM570 engine control module. Engine type is QSX15.

Terminals of controller	50 pins connector	Remark
Auxiliary output port 1	38	Oil spout switch; Set configurable output 1 as "Fuel Output".
Start relay output	-	Connect to starter coil directly

Terminals of controller	9 pins connector	Remark
CAN_SCR	SAE J1939 shield-E	CAN communication shielding line(connect to ECU terminal only)
CAN(H)	SAE J1939 signal-C	Using impedance 120Ω connecting line
CAN(L)	SAE J1939 return-D	Using impedance 120Ω connecting line

Engine type: Cummins QSX15-CM570

16.5 CUMMINS GCS-MODBUS

It is suitable for GCS engine control module. Use RS485-MODBUS to read information of engine.

Engine types are QSX15, QST30, QSK23 / 45/60/78 and so on.

Terminals of controller	D-SUB connector 06	Remark
Auxiliary output port 1	5&8	Set configurable output 1 as "Fuel Output". Outside expand relay, when fuel output, connect port 5 and 8 of the 06 connector
Start relay output	-	Connect to starter coil directly

Terminals of controller	D-SUB connector 06	Remark
RS485 GND	20	CAN communication shielding line(connect to ECU terminal only)
RS485+	21	Using impedance 120Ω connecting line
RS485-	18	Using impedance 120Ω connecting line

Engine type: Cummins QSK-MOVBUS, Cummins QST-MOVBUS, Cummins QSX-MOVBUS

16.6 CUMMINS QSM11

Terminals of controller	OEM connector of engine	Remark
Auxiliary output port 1	38	Set configurable output 1 as "Fuel Output".
Start relay output	-	Connect with starter coil directly
CAN_SCR	-	CAN communication shielding line
CAN(H)	46	Using impedance 120Ω connecting line
CAN(L)	37	Using impedance 120Ω connecting line

Engine type: common J1939

16.7 CUMMINS QSZ13

Terminals of controller	OEM connector of engine	Remark
Auxiliary output port 1	45	
Start relay output	-	Connect to starter coil directly
Auxiliary output port 2	16&41	Setting to idle speed control, normally open output. Making 16 connect to 41 during high-speed running of controller via external expansion relay.
Auxiliary output port 3	19&41	Setting to pulse raise speed control, normally open output. Making 19 connect with 41 for 0.1s during high-speed warming of controller via external expansion relay.
CAN_SCR	-	CAN communication shielding line
CAN(H)	1	Using impedance 120Ω connecting line
CAN(L)	21	Using impedance 120Ω connecting line

Engine type: Common J1939

16.8 DETROIT DIESEL DDEC III / IV

Terminals of controller	CAN port of engine	Remark
Auxiliary output port 1	Expand 30A relay, battery voltage of ECU supplied by relay	Set configurable output 1 as "Fuel Output".
Start relay output	-	Connect to starter coil directly
CAN_SCR	-	CAN communication shielding line
CAN(H)	CAN(H)	Using impedance 120Ω connecting line
CAN(L)	CAN(L)	Using impedance 120Ω connecting line

Engine type: J1939 common used

16.9 DEUTZ EMR2

Terminals of controller	F connector	Remark
Auxiliary output port 1	Expand 30A relay, battery voltage of terminal 14 is supplied by relay. Fuse is 16A	Set configurable output 1 as "Fuel Output".
Start relay output	-	Connect to starter coil directly
-	1	Connect to battery negative pole
CAN GND	-	CAN communication shielding line
CAN(H)	12	Using impedance 120Ω connecting line
CAN(L)	13	Using impedance 120Ω connecting line

Engine type: VolvoEDC4

16.10 JOHN DEERE

Terminals of controller	21 pins connector	Remark
Auxiliary output port 1	G,J	Set configurable output 1 as "Fuel Output".
Start relay output	D	
CAN_SCR	-	CAN communication shielding line
CAN(H)	V	Using impedance 120Ω connecting line
CAN(L)	U	Using impedance 120Ω connecting line

Engine type: John Deere

16.11 MTU ADEC (SAM module)

It is suitable for DEC (ECU7) and MTU engine of SAM module.

Terminals of controller	ADEC (X1port)	Remark
Auxiliary output port 1	X1 43	Set configurable output 1 as "Fuel Output". X1 Terminal 28 Connected to negative of battery
Start relay output	X1 37	X1 Terminal 22 Connected to negative of battery

Terminals of controller	SAM(X23 port)	Remark
CAN_SCR	X23 3	CAN communication shielding line
CAN(H)	X23 2	Using impedance 120Ω connecting line
CAN(L)	X23 1	Using impedance 120Ω connecting line

Engine type: Common J1939

16.12 PERKINS

It is suitable for ADEM3/ ADEM4 engine control module. Engine type is 2306, 2506, 1106, and 2806.

Terminals of controller	Connector	Remark
Auxiliary output port 1	1,10,15,33,34	Set configurable output 1 as "Fuel Output".
Start relay output	-	Connect to starter coil directly
CAN_SCR	-	CAN communication shielding line
CAN(H)	31	Using impedance 120Ω connecting line
CAN(L)	32	Using impedance 120Ω connecting line

Engine type: Perkins

16.13 SCANIA

It is suitable for S6 engine control mode. Engine type is DC9, DC12, and DC16.

Terminals of controller	B1 connector	Remark
Auxiliary output port 1	3	Set configurable output 1 as "Fuel Output".
Start relay output	-	Connect to starter coil directly
CAN GND	-	CAN communication shielding line
CAN(H)	9	Using impedance 120Ω connecting line
CAN(L)	10	Using impedance 120Ω connecting line

Engine type: Scania

16.14 VOLVO EDC3

Suitable engine control mode is TAD1240, TAD1241, and TAD1242.

Terminals of controller	"Stand alone" connector	Remark
Auxiliary output port 1	H	Set configurable output 1 as "Fuel Output".
Start relay output	E	
Auxiliary output port 2	P	ECU power Configurable output 2,"ECU power"

Terminals of controller	"Data bus" connector	Remark
CAN_SCR	-	CAN communication shielding line
CAN(H)	1	Using impedance 120Ω connecting line
CAN(L)	2	Using impedance 120Ω connecting line

Engine type: Volvo

 **NOTE:** When this engine type is selected, preheating time should be set to at least 3 seconds.

16.15 VOLVO EDC4

Suitable engine types are TD520, TAD520 (optional), TD720, TAD720 (optional), TAD721, TAD722, and TAD732.

Terminals of controller	Connector	Remark
Auxiliary output port 1	Expanded 30A relay, and relay offers battery voltage to terminal 14. Fuse is 16A	Set configurable output 1 as "Fuel Output".
Start relay output	-	Connect to starter coil directly
	1	Connected to negative of battery
CAN_SCR	-	CAN communication shielding line
CAN(H)	12	Using impedance 120Ω connecting line
CAN(L)	13	Using impedance 120Ω connecting line

Engine type: VolvoEDC4

16.16 VOLVO-EMS2

Volvo Engine types are TAD734, TAD940, TAD941, TAD1640, TAD1641, and TAD1642.

Terminals of controller	Engine's CAN port	Remark
Auxiliary output port 1	6	ECU stop Configurable output 1 "ECU stop"
Auxiliary output port 2	5	ECU power Configurable output 2 "ECU power"
	3	Negative power
	4	Positive power
CAN_SCR	-	CAN communication shielding line
CAN(H)	1(Hi)	Using impedance 120Ω connecting line
CAN(L)	2(Lo)	Using impedance 120Ω connecting line

Engine type: Volvo-EMS2

▲ NOTE: When this engine type is selected, preheating time should be set to at least 3 seconds.

16.17 Yuchai

It is suitable for BOSCH common rail pump engine.

Terminals of controller	Engine 42 pins port	Remark
Auxiliary output port 1	1.40	Set configurable output 1 as "Fuel Output". Connect to engine ignition lock
Start relay output	-	Connect to starter coil directly
CAN_SCR	-	CAN communication shielding line
CAN(H)	1.35	Using impedance 120Ω connecting line
CAN(L)	1.34	Using impedance 120Ω connecting line

Battery	Engine 2 pins	Remark
Battery negative	1	Wire diameter 2.5mm ²
Battery positive	2	Wire diameter 2.5mm ²

Engine type: BOSCH

16.18 Weichai

It is suitable for Weichai BOSCH common rail pump engine.

Terminals of controller	Engine port	Remark
Auxiliary output port 1	1.40	Set configurable output 1 as "Fuel Output". Connect to engine ignition lock
Start relay output	1.61	
CAN_SCR	-	CAN communication shielding line
CAN(H)	1.35	Using impedance 120Ω connecting line
CAN(L)	1.34	Using impedance 120Ω connecting line

Engine type: GTSC1

▲ NOTE: If there is any question of connection between controller and ECU communication, please feel free to contact SmartGen service.

17 FAULT FINDING

Symptoms	Possible Solutions
Controller no response with power.	Check starting batteries; Check controller connection wirings; Check DC fuse.
Genset shutdown	Check the water/cylinder temperature is too high or not; Check the genset AC voltage; Check DC fuse.
Low oil pressure alarm after crank disconnect	Check the oil pressure sensor and its connections.
High water temp. alarm after crank disconnect	Check the temperature sensor and its connections.
Shutdown Alarm in running	Check related switch and its connections according to the information on LCD; Check programmable inputs.
Start fail	Check fuel oil circuit and its connections; Check starting batteries; Check speed sensor and its connections; Refer to engine manual.
Starter no response	Check starter connections; Check starting batteries.