

# SmartGen

MAKING CONTROL SMARTER

## HGM6100LT SERIES (HGM6110LT/6120LT) GENSET CONTROLLER USER MANUAL



郑州众智科技股份有限公司  
SMARTGEN(ZHENGZHOU) TECHNOLOGY CO.,LTD.

**SmartGen**众智 Chinese trademark

**SmartGen** English trademark

**SmartGen** – make your generator *smart*

**SmartGen Technology Co., Ltd.**

**No.28 Jinsuo Road**

**Zhengzhou**

**Henan Province**

**P. R. China**

**Tel:** +86-371-67988888/67981888/67992951

+86-371-67981000(overseas)

**Fax:** +86-371-67992952

**Web:** [www.smartgen.com.cn/](http://www.smartgen.com.cn/)

[www.smartgen.cn/](http://www.smartgen.cn/)

**Email:** [sales@smartgen.cn](mailto:sales@smartgen.cn)

All rights reserved. No part of this publication may be reproduced in any material form (including photocopying or storing in any medium by electronic means or other) without the written permission of the copyright holder.

Applications for the copyright holder's written permission to reproduce any part of this publication should be addressed to SmartGen Technology at the address above.

Any reference to trademarked product names used within this publication is owned by their respective companies.

SmartGen Technology reserves the right to change the contents of this document without prior notice.

**Table 1 – Software Version**

Date	Version	Note
2018-10-26	1.0	Original Release.
2021-04-15	1.1	Modify the error in technical parameter and other problems.
2022-01-22	1.2	1. Modify trademark and logo; 2. Modify output port 2 normally open and COM terminal error problems in typical application diagram.
2022-04-26	1.3	Add warning, shutdown alarms and parameter setting.

# CONTENTS

1	OVERVIEW.....	5
2	PERFORMANCE AND CHARACTERISTICS .....	5
3	SPECIFICATION .....	7
4	OPERATION.....	9
4.1	KEYS DESCRIPTION.....	9
4.2	CONTROLLER PANEL .....	10
4.3	AUTOMATIC START/STOP OPERATION.....	11
4.4	MANUAL START/STOP OPERATION.....	12
4.5	EMERGENCY START.....	12
5	PROTECTION .....	13
5.1	WARNING .....	13
5.2	SHUTDOWN ALARM.....	15
6	CONNECTIONS .....	18
7	PARAMETER RANGE AND DEFINITION .....	21
7.1	PARAMETER CONTENT AND RANGE.....	21
7.2	DEFINED CONTENTS OF AUXILIARY OUTPUTS 1-4.....	29
7.3	DEFINED CONTENTS OF AUXILIARY INPUTS 1-5 .....	30
7.4	SENSOR SELECTION.....	32
7.5	CONDITIONS OF CRANK DISCONNECT SELECTION .....	33
8	PARAMETER SETTING.....	34
9	SENSOR SETTING.....	35
10	COMMISSIONING .....	36
11	TYPICAL APPLICATION .....	37
12	INSTALLATION .....	39
12.1	FIXING CLIPS.....	39
12.2	OVERALL DIMENSION AND PANEL CUTOUT .....	39
13	CONNECTIONS OF CONTROLLER WITH J1939 ENGINE.....	41
13.1	CUMMINS ISB/ISBE.....	41
13.2	CUMMINS QSL9.....	41
13.3	CUMMINS QSM11 (IMPORT).....	42
13.4	CUMMINS QSX15-CM570 .....	42
13.5	CUMMINS GCS-MOVBUS.....	43
13.6	CUMMINS QSM11.....	43

---

13.7 CUMMINS QSZ13.....	44
13.8 DETROIT DIESEL DDEC III / IV.....	44
13.9 DEUTZ EMR2.....	45
13.10 JOHN DEERE.....	45
13.11 MTU MDEC.....	45
13.12 MTU ADEC (SMART MODULE).....	46
13.13 MTU ADEC (SAM MODULE).....	46
13.14 PERKINS.....	47
13.15 SCANIA.....	47
13.16 VOLVO EDC3.....	47
13.17 VOLVO EDC4.....	48
13.18 VOLVO-EMS2.....	48
13.19 YUCHAI.....	49
13.20 WEICHAI.....	49
14 FAULT FINDING.....	50

SmartGen

## 1 OVERVIEW

**HGM6100LT** series automatic controller is specially designed for applying to extremely high/low temperature (-40°C~+70°C) environment. It is an automatic control and monitoring system for genset, which integrates digital, intelligent and network techniques. It can reliably work in extreme temperature environment due to its heated LCD and special electronic components. Moreover, it carries out functions of automatic start/stop, data measurement, alarm protection and “three remote” (remote control, remote measuring and remote communication). The controller uses LCD display, optional display interface including Chinese, English, Spanish, Russian, Portuguese, Turkish, Polish and French with easy and reliable operation.

**HGM6100LT** series automatic controller uses micro-processing technique which can achieve precision measurement, value adjustment, timing and threshold setting etc. All the parameters can be configured from front panel or use USB interface (or RS485 interface and ENETHERNET) to adjust via PC. It can be widely used in all types of automatic control system for its compact structure, simple connections and high reliability.

## 2 PERFORMANCE AND CHARACTERISTICS

**HGM6100LT** controller has two types:

**HGM6110LT:** It is used for single unit automation, controlling generator to start/stop by remote start signal;

**HGM6120LT:** Based on **HGM6110LT**, it adds mains electric quantity monitoring and mains/generator automatic switching control (AMF), especially suitable for the automation system composed by mains and genset.

Main characteristics are as below,

- 132\*64 LCD display with backlight, heated LCD in low temperature, and optional language interface (Chinese, English, Spanish, Russian, Portuguese, Turkish, Polish and French), push-button operation;
- Acrylic screen, improved wearable and scratch resistance property. Front panel includes silica-gel panel and keys;
- Widely working temperature (-40°C~+70°C) enables the module working in a place of harsh environmental conditions;
- With RS485 communication port, can achieve “three remote” functions via MODBUS protocol;
- ETHERNET communication port works together with cloud monitoring platform and mobile phone APP can realize monitor function for genset at any time in any place;
- With CANBUS port which can be connected to electronic injection with J1939, it not only can monitor frequently-used data (such as water temperature, oil pressure, speed and fuel consumption, etc.) but also can control start, stop, high speed and low speed (controller with CANBUS port is needed) via CANBUS port.
- Adapt to 3P4W, 3P3W, 1P2W and 2P3W (120V/240V), 50Hz/60Hz power system;
- Can measure and display 3 phase voltage, 3 phase current, frequency, power parameter of

mains/gens;

**Mains**

Line voltage (Uab, Ubc, and Uca)

Phase voltage (Ua, Ub, and Uc)

Frequency Hz

Phase sequence

**Generator**

Line voltage (Uab, Ubc, and Uca)

Phase voltage (Ua, Ub, and Uc)

Frequency Hz

Phase sequence

**Load**

Current IA, IB, IC

Split-phase and total active power kW

Reactive power kvar

Apparent power KVA

Power factor PF

Generator accumulated energy kWh

Output percentage with load %

- For mains, it has detection functions of over/under voltage and lack of phase; For gen, it has detection functions of over/under voltage, over/under frequency, over current and over power, and short –circuit protection function;
- Precisely measure and display of parameters about engine,
 

Temp. (WT),	°C/°F		
Oil pressure (OP)	kPa/psi/bar		
Fuel level (FL)	%	Fuel remains	L
Speed (SPD),	r/min		
Battery voltage (VB)	V		
Charger voltage (VD)	V		
Accumulative running hours			
Accumulative start times			
- Control protection: Automatic start/stop of genset, breaker close/open (ATS control) and perfect fault display and protection;
- With ETS, idle control, pre-heat control, speed raise/drop control, all of them are relay outputs;
- Parameter setting: Allow user to modify setting and store them in internal FLASH memory. The parameters cannot be lost even when power off. All of parameters can be set not only from the front panel, but also use USB interface (or RS485 interface, ETHERNET) to adjust them via PC.;
- Multiple sensors of temperature, pressure and fuel level can be used directly, parameters can be defined by user;
- Multiple conditions of crank disconnect (speed sensor, oil pressure, generator frequency) can be selected;
- With emergency start function;
- With flywheel teeth numbers automatic identification function;
- Widely power supply range: (8~35)VDC, accommodating to different starting battery voltage environment;

- All parameters use digital modulation, instead of analog modulation using conventional potentiometer, having improved reliability and stability;
- With maintenance function. Types (date or running time) can be selected and actions (warning or alarm shutdown) can be set when maintenance time out;
- Event log (max.99 pieces), real-time clock, scheduled start & stop (can be set as start unit once a day/week/month whether with load or not);
- Add rubber gasket between shell and controller screen, the waterproof can reach IP65;
- Controller is fixed by metal fixing clips;
- Modular design, flame-retardant ABS shell, embedded mounting, compact structure and easy installation.

### 3 SPECIFICATION

**Table 2 – Technical Parameters**

Item	Content
Working Voltage	DC8.0V to DC35.0V, continuous power supply
Power Consumption	LCD without heating: <6W (standby: ≤2W) LCD with heating: <10W (standby: ≤6W)
AC System	
3P4W	15V AC - 360 V AC (ph-N)
3P3W	30V AC - 620 V AC (ph-ph)
1P2W	15V AC - 360 V AC (ph-N)
2P3W	15V AC - 360 V AC (ph-N)
AC Alternator Frequency	50Hz/60Hz
Speed Sensor Voltage	1.0V to 24V (RMS)
Speed Sensor Frequency	10,000 Hz (max.)
Start Relay Output	16A DC28V at supply voltage
Fuel Relay Output	16A DC28V at supply voltage
Auxiliary Relay Output 1	7A DC28V at supply voltage
Auxiliary Relay Output 2	7A AC250V volt-free output
Auxiliary Relay Output 3	16A AC250V volt-free output
Auxiliary Relay Output 4	16A AC250V volt-free output
USB Device	Type-B USB female port
RS485	Isolated RS485 port, Modbus-RTU protocol
ETHERNET	RJ45 10/100Mbps self-adapt network interface Cloud monitoring protocol and TCP/IP Modbus protocol
LCD Display	Under the condition of -40°C, the controller can display normally within 20s after power-on; after 2 minutes after power-on, the dynamic display response speed is normal.
Overall Dimensions	209mm x 166mm x 45mm
Panel Cutout	186mm x 141mm
C.T. Secondary Current	5A (rated)
Working Temperature	(-40~70)°C

Item	Content
Working Humidity	(20~93)%RH
Storage Temperature	(-40~70)°C
Protection Level	IP65: when water-proof gasket installed between control panel and enclosure.
Insulation Strength	Apply AC2.2kV voltage between high voltage terminal and low voltage terminal. The leakage current is not more than 3mA within 1min.
Weight	0.65kg











SmartGen



## 4 OPERATION

### 4.1 KEYS DESCRIPTION

**Table 3 – Keys Description**

Icon	Function	Description
	Stop/Reset	Can stop generator under Manual/Auto mode; Can reset shutdown alarm; Press this key at least 3 seconds to test panel indicators are OK or not (lamp test); During stopping process, press this key again can stop generator immediately.
	Start	Press it will start standby genset under Manual mode; genset will jump to next status if press this key in starting process.
	Manual	Pressing this key will set the module as Manual mode.
	Auto	Pressing this key will set the module as Auto mode.
	Close/Open	Can control gens to switch on or off in Manual mode. Note: the key is fit for HGM6120LT controller.
	Close	Can control gens to switch on in Manual mode. Note: the key is fit for HGM6110LT controller.
	Open	Can control gens to switch off in Manual mode. Note: the key is fit for HGM6110LT controller.
	Set/Confirm	Press this key to enter menu interface; Shift cursor to confirm in parameters setting menu.
	Up/Increase	Screen scroll; Up cursor and increase value in setting menu.
	Down/Decrease	Scroll screen; Down cursor and decrease value in setting menu.
	Home/Return	Return to homepage when in main interface; Exit when in parameters setting interface.

**4.2 CONTROLLER PANEL**



**Fig.1 – HGM6110LT Front Panel Indication**

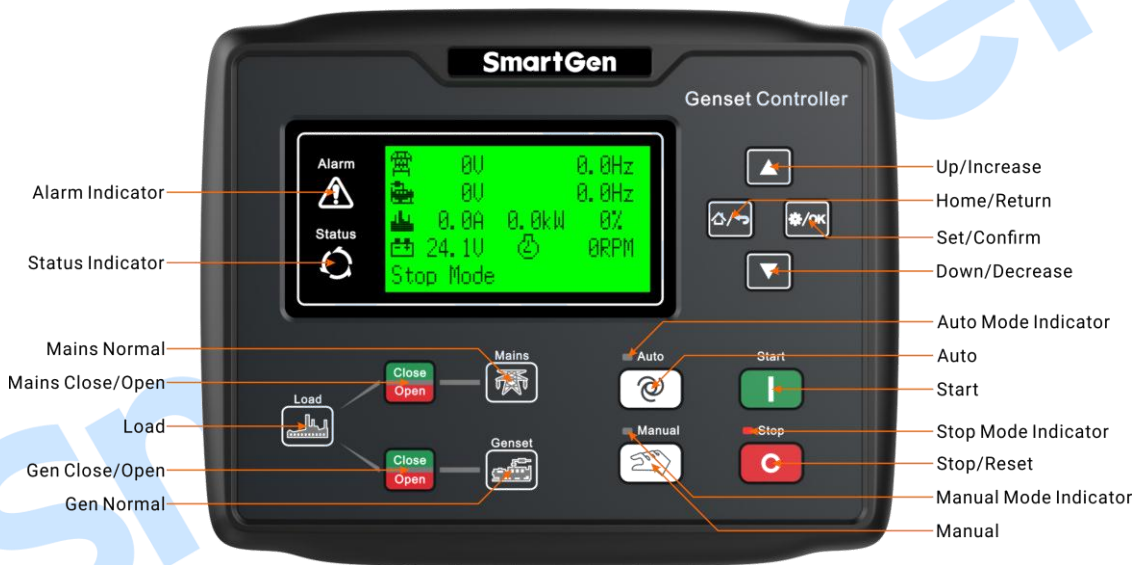

**Fig.2 – HGM6120LT Front Panel Indication**

**NOTE:** Partial indicator states

**Alarm Indicator:** slowly blink when warning alarms; fast blink when shutdown alarms; won't illuminate when there is no alarm.

**Status Indicator:** won't illuminate when genset stand by; blink 1 time per second in start or stop process and always illuminate when runs normally; for J1939 gensets, press start key in auto mode or stop mode, ECU power outputs and status indicator always illuminates.

**Auto Mode Indicator:** only illuminate in auto mode; blink in auto mode and start delay count down.

### 4.3 AUTOMATIC START/STOP OPERATION

Auto mode is activated by pressing the  , LED indicator beside it is illuminating which confirms this action.









#### Starting Sequence,

- 1) **HGM6120LT:** When mains is abnormal (over/under voltage, lack of phase), it enters into "Mains Abnormal Delay" and LCD displays count-down time. When delay is over, "Start Delay" begins.
- 2) **HGM6110LT:** When "Remote Start" input is active, it enters into "Start Delay";
- 3) "Start Delay" countdown is displayed in LCD;
- 4) When start delay is over, preheat relay is outputting (if configured), "Preheat Delay XX s" is displayed in LCD;
- 5) When preheat delay is over, fuel relay is outputting for 1s and then start relay outputs; if genset failed to start during "Crank Time", the fuel and start relay stop outputting and it enters into "Crank Rest Time" and wait for next cranking;
- 6) If genset failed to start within set start times, the fifth line of LCD will turn black and "Fail to Start" alarm will be displayed;
- 7) Any time to start genset successfully, it will enter into "Safe Running". During this period, alarms of low oil pressure, high temperature, under speed, failed to charge and Aux. input (be configured) are disabled. As soon as this delay is over, genset will enter into "Start Idle Delay" (if configured);
- 8) During start idle delay, alarms of under speed, under frequency, under voltage are disabled. As soon as this delay is over, genset will enter into "Warming Up Delay" (if configured);
- 9) When "Warming Up Delay" is over, the indicator is illuminating if gens normal. If voltage and frequency reach the load requirement, close relay outputs, genset will take load and indicator illuminates; if voltage or frequency is abnormal, controller will alarm and shutdown (LCD displays the alarm information).



#### Stopping Sequence,

- 1) **HGM6120LT:** During normal running, if mains normal, genset will enter into "Mains Normal Delay", when mains indicator illuminates, "Stop Delay" begins;
- 2) **HGM6110LT:** Genset enters into "Stop Delay" as soon as "Remote Start" is inactive;
- 3) When "Stop Delay" is over, genset enters into "Cooling Delay". Closing relay is disconnected. After switch "Transfer Rest Delay", closing relay is outputting, mains will take load, generator indicator extinguishes while mains indicator illuminates;
- 4) When entering "Stop Idle Delay", idle relay is energized to output. (If configured);
- 5) When entering "ETS Delay", ETS relay is energized to output, fuel relay output is disconnected;
- 6) When entering "Genset at Rest", genset will automatically judge if it has stopped;
- 7) When genset stops, it will enter into standby mode; if genset failed to stop, controller will issue alarm ("Fail to Stop" alarm will be displayed in LCD).

#### 4.4 MANUAL START/STOP OPERATION

- 1) **HGM6120LT:** Manual Mode is active when press  and its indicator illuminates. Under this mode, press  to start genset, it can automatically detect crank disconnect and accelerate to high speed running. If there is high temperature, low oil pressure, over speed and abnormal voltage during genset running, controller can protect genset to stop (detail procedures please refer to No.4~9 of Auto start sequence). Under Manual Mode, switch won't transfer automatically, it is necessary to manually press   to transfer load.
- 2) **HGM6110LT:** Manual Mode is active when pressing , and its indicator is illuminating. Then press  to start genset, it can automatically detect crank disconnect and accelerate to high speed running. If there is high temperature, low oil pressure, over speed and abnormal voltage during running, controller can protect genset to stop quickly (detail procedures please refer to No.4~9 of Auto start sequence). After genset runs well in high speed, press  and gen takes load.
- 3) Manual stop, pressing  can shut down the running genset (detail procedures please refer to No.3~7 of Auto stop sequence).

#### 4.5 EMERGENCY START

In manual mode, pressing  and  simultaneously can compel genset to start. The controller won't judge whether the controller has started successfully according to disconnect conditions and the disconnection of starter is controlled by operators. When operators observed the genset has started successfully, loose the keys and the controller enters safety delay with start stops to output.

## 5 PROTECTION

### 5.1 WARNING

When controller detects the warning signal, genset only sends alarm and not stop. The alarms are displayed in LCD.

**Table 4 – Warning Alarms**

No.	Warning	Description
1	Loss of Speed Signal	When the speed of genset is 0 and speed loss delay is 0, controller will send warning alarm signal and it will be displayed in LCD.
2	Gen Over Current	When the current of genset is higher than threshold (definite time) and setting over current delay is 0, controller will send warning alarm signal and it will be displayed in LCD.
3	Failed to Stop	When genset cannot stop after the “ETS delay/fail to stop delay” is over, controller will send warning alarm signal and it will be displayed in LCD.
4	Low Fuel Level	When the fuel level of genset is lower than threshold or low fuel level warning is active, controller will send warning alarm signal and it will be displayed in LCD.
5	Failed to Charge	When the voltage of genset charger is lower than threshold, controller will send warning alarm signal and it will be displayed in LCD.
6	Battery Under Voltage	When the battery voltage of genset is lower than threshold, controller will send warning alarm signal and it will be displayed in LCD.
7	Battery Over Voltage	When the battery voltage of genset is higher than threshold, controller will send warning alarm signal and it will be displayed in LCD.
8	Low Coolant Level	When low coolant level input is active, controller will send warning alarm signal and it will be displayed in LCD.
9	Temp. Sensor Open	When sensor hasn't connected to corresponding port, controller will send warning alarm signal and it will be displayed in LCD.
10	OP Sensor Open	When sensor hasn't connected to corresponding port, controller will send warning alarm signal and it will be displayed in LCD.
11	Maintenance Due	Maintenance type is running time. When genset running time is longer than maintenance time of user setting or the maintenance type is date, the current date is over the set value, and the maintenance action is set as warn, controller send warning alarm signal and it will be displayed in LCD.
12	High Temp.	When the water/cylinder temperature of genset is higher than threshold and Enabled High Temp. Stop Inhibited or Input High Temp. Stop Inhibited is active, controller will send warning alarm signal and it will be displayed in LCD.
13	Low Oil Pressure	When the oil pressure of genset is less than threshold and Enabled Low Oil Pressure Stop Inhibited or Input Low Oil Pressure Stop Inhibited is active, controller will send warning alarm signal and it will be displayed in LCD.

No.	Warning	Description
14	Input Warn	When external input is active, controller will send warning alarm signal and it will be displayed in LCD.
15	Failed to Charge IN	When Failed To Charge input is active, controller will send warning alarm signal and it will be displayed in LCD.
16	Over Power	If over power detection is enabled, when the controller detects that the over power value (power is positive) has exceeded the pre-set value and the action selects "Warn", it will initiate a warning alarm.
17	ECU Warn	If an error message is received from ECU via J1939, it will initiate a warning alarm.
18	Short-circuit Alarm	When short-circuit signal is enabled, and the short-circuit action selects "Warn", controller will initiate a warning alarm after meeting the short-circuit requirements.
19	User Configured Warn 1	When controller detects that the input port 1 selects 33 "User Configured", close/open is active and the action selects "Warn", when the controller meets the selection of active range ( not inactive ), the controller will initiate shutdown alarm signal, and the LCD will display the "User Configured 1" warning.
20	User Configured Warn 2	When controller detects that the input port 2 selects 33 "User Configured", close/open is active and the action selects "Warn", when the controller meets the selection of active range ( not inactive ), the controller will initiate shutdown alarm signal, and the LCD will display the "User Configured 2" warning.
21	User Configured Warn 3	When controller detects that the input port 3 selects 33 "User Configured", close/open is active and the action selects "Warn", when the controller meets the selection of active range ( not inactive ), the controller will initiate shutdown alarm signal, and the LCD will display the "User Configured 3" warning.
22	User Configured Warn 4	When controller detects that the input port 4 selects 33 "User Configured", close/open is active and the action selects "Warn", when the controller meets the selection of active range ( not inactive ), the controller will initiate shutdown alarm signal, and the LCD will display the "User Configured 4" warning.
23	User Configured Warn 5	When controller detects that the input port 5 selects 33 "User Configured", close/open is active and the action selects "Warn", when the controller meets the selection of active range ( not inactive ), the controller will initiate shutdown alarm signal, and the LCD will display the "User Configured 5" warning.

## 5.2 SHUTDOWN ALARM

When controller detects shutdown alarm, it will send signal to open switch and stop genset. The alarms are displayed in LCD.

**Table 5 – Shutdown Alarms**

No.	Items	Description
1	Emergency Stop	When controller detects emergency stop signal, it will send a shutdown alarm signal and it will be displayed in LCD.
2	High Temp.	When the temperature of water/cylinder is higher than set threshold, controller will send a shutdown alarm signal and it will be displayed in LCD.
3	Low Oil Pressure	When oil pressure is lower than threshold, controller will send a shutdown alarm signal and it will be displayed in LCD.
4	Over Speed	When genset speed is higher than set threshold, controller will send a shutdown alarm signal and it will be displayed in LCD.
5	Under Speed	When genset speed is lower than set threshold, controller will send a shutdown alarm signal and it will be displayed in LCD.
6	Loss of Speed Signal	When speed is 0 and delay is not 0, controller will send a shutdown alarm signal and it will be displayed in LCD.
7	Gen Over Voltage	When genset voltage is higher than threshold, controller will send a shutdown alarm signal and it will be displayed in LCD.
8	Gen Under Voltage	When genset voltage is under set threshold, controller will send a shutdown alarm signal and it will be displayed in LCD.
9	Gen Over Current	When genset current is higher than set threshold and delay is not 0, it will send a shutdown alarm signal and it will be displayed in LCD.
10	Failed to Start	Within set start times, if failed to start, controller will send a shutdown alarm signal and it will be displayed in LCD.
11	Gen Over Freq.	When genset frequency is higher than set threshold, controller will send a shutdown alarm signal and it will be displayed in LCD.
12	Gen Under Freq.	When genset frequency is lower than set threshold, controller will send a shutdown alarm signal and it will be displayed in LCD.
13	No Gens	When genset frequency is 0, controller will send a shutdown alarm signal and it will be displayed in LCD.
14	Low Fuel Level	When low fuel level input is active, controller will send a shutdown alarm signal and it will be displayed in LCD.
15	Low Coolant Level	When genset coolant level low input is active, controller will send a shutdown alarm signal and it will be displayed in LCD.
16	Temp. Sensor Open	When sensor hasn't connected to corresponding port, controller will send shutdown alarm signal and it will be displayed in LCD.
17	OP Sensor Open	When sensor hasn't connected to corresponding port, controller will send shutdown alarm signal and it will be displayed in LCD.
18	Maintenance Due	Maintenance type is running time. When genset running time is longer



No.	Items	Description
		than maintenance time of user setting or the maintenance type is date, the current date is over the set value, and maintenance action is set as shutdown, controller send shutdown alarm signal and it will be displayed in LCD. Maintenance alarm can be reset by setting maintenance parameters with password.
19	Input Shutdown	When external input is active, controller will send shutdown alarm signal and it will be displayed in LCD.
20	Over Power	If over power detection is enabled, when the controller detects that the over power value (power is positive) has exceeded the pre-set value and the action selects "Shutdown", it will initiate a shutdown alarm.
21	ECU Shutdown	If an error message is received from ECU via J1939, it will initiate a shutdown alarm.
22	ECU Comm. Failure	If the module does not detect the ECU data, it will initiate a shutdown alarm.
23	Short-circuit Shutdown	When short-circuit signal is enabled, and the short-circuit action selects "Shutdown Alarm", controller will initiate a shutdown alarm signal after meeting the short-circuit requirements.
24	User Configured 1 Shutdown	When controller detects that the input port 1 selects 33 "User Configured", close/open is active and the action selects "Shutdown Alarm", when the controller meets the selection of active range ( not inactive ) , the controller will initiate a shutdown alarm signal, and the LCD will display the "User Configured 1 Shutdown".
25	User Configured 2 Shutdown	When controller detects that the input port 2 selects 33 "User Configured", close/open is active and the action selects "Shutdown Alarm", when the controller meets the selection of active range ( not inactive ) , the controller will initiate a shutdown alarm signal, and the LCD will display the "User Configured 2 Shutdown".
26	User Configured 3 Shutdown	When controller detects that the input port 3 selects 33 "User Configured", close/open is active and the action selects "Shutdown Alarm", when the controller meets the selection of active range ( not inactive ) , the controller will initiate a shutdown alarm signal, and the LCD will display the "User Configured 3 Shutdown".
27	User Configured 4 Shutdown	When controller detects that the input port 4 selects 33 "User Configured", close/open is active and the action selects "Shutdown Alarm", when the controller meets the selection of active range ( not



No.	Items	Description
		inactive ) , the controller will initiate a shutdown alarm signal, and the LCD will display the "User Configured 4 Shutdown".
28	User Configured 5 Shutdown	When controller detects that the input port 5 selects 33 "User Configured", close/open is active and the action selects "Shutdown Alarm", when the controller meets the selection of active range ( not inactive ) , the controller will initiate a shutdown alarm signal, and the LCD will display the "User Configured 1 Shutdown".

**▲NOTE:** ECU warning and shutdown alarm explains that check engine according to displayed alarm contents; otherwise check engine user manual according to SPN alarm code for gaining information.



## 6 CONNECTIONS

Compared with HGM6120LT, HGM6110LT doesn't have 3-phase input terminal of mains voltage. The back panel of HGM6120LT is as below.

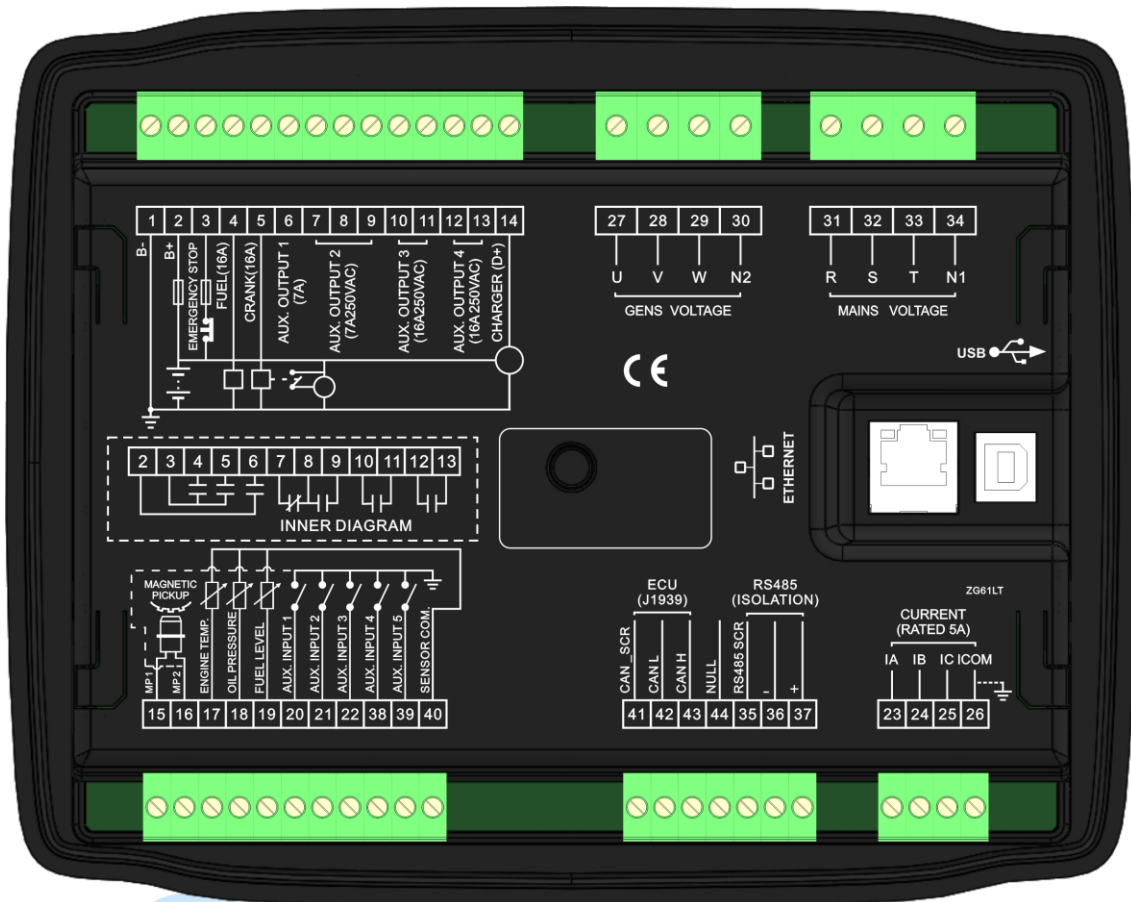

**Fig.3 – Controller Back Panel Drawing**

**Table 6 – Terminal Connection Description**

No.	Function	Cable Size	Description
1	B-	2.5mm <sup>2</sup>	Connected to negative of starting battery.
2	B+	2.5mm <sup>2</sup>	Connected to positive of starting battery. If wire length is over 30m, better to double wires in parallel. Max. 20A fuse is recommended.
3	Emergency Stop	2.5mm <sup>2</sup>	Connected to B+ via emergency stop button.
4	Fuel Relay Output	1.5mm <sup>2</sup>	B+ is supplied by 3 points, rated 16A.
5	Start Relay Output	1.5mm <sup>2</sup>	B+ is supplied by 3 points, rated 16A. Connect to starter coil.
6	Aux. Relay Output 1	1.5mm <sup>2</sup>	B+ is supplied by 2 points, rated 7A.
7			Normally close output, 7A rated.
8	Aux. Relay Output 2	1.5mm <sup>2</sup>	Relay common port.
9			Normally open output, 7A rated.
10	Aux. Relay Output 3	2.5mm <sup>2</sup>	Relay normally open volt-free contact output. 16A rated.
11			
12	Aux. Relay Output 4	2.5mm <sup>2</sup>	
13			
14	ChargerD+ Input	1.0mm <sup>2</sup>	Connect to D+ (WL) terminal. If without, the terminal is not connected.
15	Speed Sensor Input		Connected to speed sensor, shielding line is recommended.
16	Speed sensor input, B- is connected.	0.5mm <sup>2</sup>	
17	Temp. Sensor Input	1.0mm <sup>2</sup>	Connect to water/cylinder temp. resistance type sensor.
18	Oil Pressure Sensor Input	1.0mm <sup>2</sup>	Connect to oil pressure resistance type sensor.
19	Level Sensor Input	1.0mm <sup>2</sup>	Connect to level resistance type sensor.
20	Aux. Input 1	1.0mm <sup>2</sup>	Ground connected is active (B-).
21	Aux. Input 2	1.0mm <sup>2</sup>	Ground connected is active (B-).
22	Aux. Input 3	1.0mm <sup>2</sup>	Ground connected is active (B-).
23	CT A Phase Sensing Input	1.5mm <sup>2</sup>	External connect CT secondary coil (rated 5A).
24	CT B Phase Sensing Input	1.5mm <sup>2</sup>	External connect CT secondary coil (rated 5A).
25	CT C Phase Sensing Input	1.5mm <sup>2</sup>	External connect CT secondary coil (rated 5A).
26	CT Common Port	1.5mm <sup>2</sup>	Refer to INSTALLATION description.
27	Generator U phase Voltage Sensing Input	1.0mm <sup>2</sup>	Connect to U phase output (2A fuse is recommended).
28	Generator V phase Voltage sensing Input	1.0mm <sup>2</sup>	Connect to V phase output (2A fuse is recommended).
29	Generator W phase Voltage Sensing Input	1.0mm <sup>2</sup>	Connect to W phase output (2A fuse is recommended).

No.	Function	Cable Size	Description	
30	Generator N2 Input	1.0mm <sup>2</sup>	Connect to generator N-wire.	
31	Mains R phase Voltage Sensing Input	1.0mm <sup>2</sup>	Connect to mains R phase (2A fuse is recommended) <b>(HGM6110LT without.)</b>	
32	Mains S phase Voltage Sensing Input	1.0mm <sup>2</sup>	Connect to mains S phase (2A fuse is recommended) <b>(HGM6110LT without.)</b>	
33	Mains T phase Voltage Sensing Input	1.0mm <sup>2</sup>	Connect to mains T phase, (2A fuse is recommended) <b>(HGM6110LT without.)</b>	
34	Mains N1 Input	1.0mm <sup>2</sup>	Connect to mains N-wire. <b>(HGM6110LT without.)</b>	
35	RS485 Common Ground	/	Impedance-120Ω shielding wire is recommended, its single-end connect with ground.	
36	RS485-	0.5mm <sup>2</sup>		
37	RS485+	0.5mm <sup>2</sup>		
38	Aux. Input 4	1.0mm <sup>2</sup>	Ground connected is active (B-).	Reference Table 9.
39	Aux. Input 5	1.0mm <sup>2</sup>	Ground connected is active (B-).	
40	Sensor COM	1.0mm <sup>2</sup>	Sensor common port.	
41	CAN COM	0.5mm <sup>2</sup>	Impedance-120Ω shielding wire is recommended, its single-end connects with ground (connect this port to engine ECU if engine type is not “conventional engine”).	
42	CAN L	0.5mm <sup>2</sup>		
43	CAN H	0.5mm <sup>2</sup>		
44	NULL			

**▲NOTE 1:** USB port in controller rear panel is configurable parameter port; user can directly program via PC.

**▲NOTE 2:** ETHERNET port in controller rear panel is network monitoring port; user can directly program via PC.

## 7 PARAMETER RANGE AND DEFINITION

### 7.1 PARAMETER CONTENT AND RANGE

**Table 7 – Parameter Content and Range**

No.	Items	Range	Default	Description
1	Mains Normal Delay	(0-3600)s	10	The delay from abnormal to normal or from normal to abnormal. It used for ATS (automatic transfer switch) control.
2	Mains Abnormal Delay	(0-3600)s	5	
3	Mains Under Voltage	(30-60000)V	184	When mains voltage is under the point, mains under voltage active. When the value is 30V, mains under voltage disabled. Return difference is 10V.
4	Mains Over Voltage	(30-60000)V	276	When mains voltage is greater than the point, mains over voltage active. When the point is 60000V, mains over voltage disabled. Return difference is 10V.
5	Transfer Delay	(0-99.9)s	1.0	It's the delay from mains open to generator closed or from generator open to mains closed.
6(1)	Start Delay	(0-3600)s	1	Time from mains abnormal or remote start signal is active to start genset.
7(2)	Stop Delay	(0-3600)s	1	Time from mains normal or remote start signal is inactive to stop genset.
8(3)	Start Attempts	(1-10)times	3	When engine start failure, it's the maximum cranking times. When setting crank times out, controller send start fail signal.
9(4)	Preheat Time	(0-300)s	0	Time of pre-powering heat plug before starter is powered up.
10(5)	Cranking Time	(3-60)s	8	Time of starter power up each time.
11(6)	Crank Rest Time	(3-60)s	10	The second waiting time before power up when engine start fail.
12(7)	Safety On Time	(1-60)s	10	Alarm for low oil pressure, high temp, under speed, under frequency/voltage, failed to charge are all inactive.
13(8)	Start Idle Time	(0-3600)s	0	Idle running time of genset when starting.
14(9)	Warming Up Time	(0-3600)s	10	Warming up time between genset switch on and high speed running.
15(10)	Cooling Time	(3-3600)s	10	Time for cooling before stopping.
16(11)	Stop Idle Time	(0-3600)s	0	Idle running time when genset stop.
17(12)	ETS Solenoid Hold	(0-120)s	20	Stop electromagnet's power on time when genset is stopping.
18(13)	Fail to Stop Delay	(0-120)s	0	If "ETS output time" set as 0, it is the time from end of idle delay to genset at rest; if not

No.	Items	Range	Default	Description
				0, it is from end of ETS solenoid delay to genset at rest.
19(14)	Switch Close Time	(0.0-10.0)s	5.0	Mains' or generator's switch closing pulse width, when it is 0, output is continuous.
20(15)	Flywheel Teeth	(10.0-300.0)	118	Number of flywheel teeth, it can detect disconnection conditions and engine speed.
21(16)	Gen Abnormal Delay	(0-20.0)s	10.0	Over or under voltage alarm delay.
22(17)	Gen Over Voltage Shutdown	(30-60000)V	264	When genset voltage is over the point, generator over voltage is active. When the point is 60000V, generator over voltage is disabled.
23(18)	Gen Under Voltage Shutdown	(30-60000)V	196	When generator voltage is under the point, generator under voltage is active. When the point is 30V, generator under voltage is disabled.
24(19)	Gen Under Speed Shutdown	(0-6000)r/min	1200	When the engine speed is under the point for 10s, shutdown alarm signal is sent out.
25(20)	Gen Over Speed Shutdown	(0-6000)r/min	1710	When the engine speed is over the point for 2s, shutdown alarm signal is sent.
26(21)	Gen Under Frequency Shutdown	(0-75.0)Hz	45.0	When generator frequency is lower than the point (not equal to 0) for 10s, shutdown alarm signal is sent.
27(22)	Gen Over Frequency Shutdown	(0-75.0)Hz	57.0	When generator's frequency is over the point and continues for 2s, generator over frequency is active.
28(23)	High Temperature Shutdown	(80-300)°C	98	When external connected temperature sensor value is over this point, it sends out high temp. alarm. This value is only judged for external connected temp. sensor after safety on time is over. When the value is 300, warning alarm won't be sent. (only suited for temperature sensor, except for high temp. alarm signal inputted by programmable input port.)
29(24)	Low Oil Pressure Shutdown	(0-400)kPa	103	When external connected oil pressure sensor value is under this point, low oil pressure delay is started (judged after safety on time is over). When the value is 0, warning alarm won't be sent. (only suited for oil pressure sensor, except for low oil pressure alarm signal inputted by programmable input port.)
30(25)	Low Fuel Level	(0-100)%	10	When fuel level sensor value under this point

No.	Items	Range	Default	Description
	Warning Value			and remains for 10s, genset sends out warning alarm, only warn but not shutdown.
31(26)	Loss of Speed Signal Delay	(0-20.0)s	5.0	When the delay setting as 0s, it only warn but not shutdown.
32(27)	Charge Alternator Fail Voltage Difference	(0-30)V	6.0	During generator is running, when voltage difference between B+ and D+(WL) of charger is higher than this point and remains for 5s, controller will initiate shutdown alarm.
33(28)	Battery Over Voltage	(12-40)V	33.0	When generator battery voltage is over the point and remains for 20s, battery over voltage signal is active. It only warn but not shutdown.
34(29)	Battery Under Voltage	(4-30)V	8.0	When generator battery voltage is under the point and remains for 20s, battery under voltage signal is active. It only warn but not shutdown.
35(30)	CT Ratio	(5-6000)/5	500	External connected current transformer ratio.
36(31)	Full Load Current	(5-6000)A	500	Rated current of generator, used for calculating over load current.
37(32)	Over Current PCT	(50-130)%	120	When load current is over the point, the over current delay is initiated.
38(33)	Over Current Delay	(0-3600)s	30	It is definite time. When load current is over the point and remains for preset time, over current signal is sent. When the delay is 0, only warn but not shutdown.
39(34)	Fuel Pump On	(0-100)%	25	When the fuel level is lower than the set value for 2s, send a signal to open fuel pump.
40(35)	Fuel Pump Off	(0-100)%	80	When the fuel level is higher than the set value for 2s, send a signal to close fuel pump.
41(36)	Aux. Output 1 Set	(0-26)	2	Factory default: Energized to stop. See table 8
42(37)	Aux. Output 2 Set	(0-26)	3	Factory default: Idle control. See table 8.
43(38)	Aux. Output 3 Set	(0-26)	5	Factory default: Gen close output. See table 8
44(39)	Aux. Output 4 Set	(0-26)	6	Factory default: Mains close output. See table 8.
45(40)	Aux. Input 1 Set	(0-23)	1	Factory default: High temperature shutdown. See table 9.
46(41)	Aux. Input 1 Active	(0-1)	0	Factory default: close.
47(42)	Aux. Input 1 Delay	(0-20.0)s	2.0	



No.	Items	Range	Default	Description
48(43)	Aux. Input 2 Set	(0-23)	2	Factory default: Low oil pressure shutdown. See table 9.
49(44)	Aux. Input 2 Active	(0-1)	0	Factory default: close.
50(45)	Aux. Input 2 Delay	(0-20.0)s	2.0	
51(46)	Aux. Input 3 Set	(0-23)	10	Factory default: Remote start. See table 9.
52(47)	Aux. Input 3 Active	(0-1)	0	Factory default: close to activate.
53(48)	Aux. Input 3 Delay	(0-20.0)s	2.0	
54(49)	Aux. Input 4 Set	(0-23)	11	Factory default: Low fuel level warn. See table 9.
55(50)	Aux. Input 4 Active	(0-1)	0	Factory default: close.
56(51)	Aux. Input 4 Delay	(0-20.0)s	2.0	
57(52)	Aux. Input 5 Set	(0-23)	12	Factory default: Low coolant level warn. See table 9.
58(53)	Aux. Input 5 Active	(0-1)	0	Factory default: close.
59(54)	Aux. Input 5 Delay	(0-20.0)s	2.0	
60(55)	Power On Mode	(0-2)	0	0: Stop Mode; 1: Manual Mode; 2: Auto Mode
61(56)	Module Address	(1-254)	1	The communication address of controller.
62(57)	Password	(0-9999)	0318	See <b>NOTE 5</b> .
63(58)	Crank Disconnect Condition	(0-6)	2	Conditions of disconnecting starter (generator frequency, magnetic pickup sensor, oil pressure), Each condition can be used alone and simultaneously to separating the start motor and engine as soon as possible.
64(59)	Engine Speed of Crank Disconnect	(0-3000)r/min	360	When engine speed is over this point, starter will disconnect.
65(60)	Frequency of Crank Disconnect	(0.0-30.0)Hz	14.0	When generator frequency is over this point, starter will disconnect.
66(61)	Oil Pressure of Crank Disconnect	(0-400)kPa	200	When the oil pressure is over this point, starter will disconnect.
67(62)	High Temp. Shut Inhibit	(0-1)	0	Default: when temperature is too high, the genset alarms and shuts down. See <b>NOTE3</b> .
68(63)	Low OP Shut Inhibit	(0-1)	0	Default: when oil pressure is too low, it alarms and shuts down. See <b>NOTE4</b> .
69(64)	AC System	(0-3)	0	0: 3P4W 1: 2P3W 2: 1P2W 3: 3P3W
70(65)	Temp. Sensor Curve Type	(0-14)	4	SGD. See table 10.
71(66)	Pressure Sensor Curve Type	(0-14)	4	SGD. See table 10.
72(67)	Fuel Level Sensor Curve Type	(0-7)	3	SGD. See table 10.



No.	Items	Range	Default	Description
73(68)	Generator Poles	(2-64)	4	Number of magnetic poles, used for calculating speed of engine without speed sensor.
74(69)	Temp. Sensor Open Circuit Action	(0-2)	1	0: Not used; 1: Warn; 2: Shutdown
75(70)	Oil Pressure Sensor Open Circuit Action	(0-2)	1	
76(71)	Disconnect Oil Pressure Delay	(0-20.0)s	0.0	When disconnect conditions include oil pressure and engine oil pressure is higher than disconnect oil pressure delay, the genset is regarded as start successfully and starter will disconnect.
77(72)	Scheduled Run	(0-1)	0	0: Disabled; 1: Enabled.
78(73)	Cycle Setting	(0-2)	0	Circulate condition: monthly, weekly and daily can be selected. Start time and duration can be set.
79(74)	Auto Start Inhibit	(0-1)	0	0: Disabled; 1: Enabled.
80(75)	Cycle Setting	(0-2)	0	Circulate condition: monthly, weekly and daily can be selected. Don't start time and duration can be set.
81(76)	Over Power	(0-2)	0	0: Not used; 1: Warn; 2: Shutdown When power is higher than preset value and duration exceeds than delay, over power warning is active. Return and delay value can be set.
82(77)	Start Interface	(0-1)	0	0: Disabled; 1: Enabled. Start interface delay can be set.
83(78)	Maintenance Password	(0-9999)	0	Enter password interface of maintenance configuration.
84(79)	Date/Time	Set the date/time of controller.		
85(80)	Flexible Sensor Curve Type	(0-2)	0	0: User-defined temperature sensor 1: User-defined pressure sensor 2: User-defined level sensor Choose sensor which need to be set, input every point (8 points need to be input) resistance and corresponding value (or current, voltage) of curve.
86(81)	Engine Type	(0-39)	0	0: Conventional Engine.
87(82)	SPN Alarm Version	(0-3)	0	SPN Alarm Version.
88(83)	Custom Theme	(0-2)	0	0: Default Theme; 1: OEM Plant Theme; 2: Terminal User Theme
89(84)	Fuel Output Time	(1-60)s	1	It is the time of the genset fuel output during

No.	Items	Range	Default	Description
				power on.
90(85)	Manual Mode ATS	(0-1)	0	0: Key Switch; 1: Auto Switch.
91(86)	Speed Raise Pulse	(0-20.0)s	0.2	It is the speed-up pulse output time, when the unit enters the high-speed warm-up.
92(87)	Speed Drop Pulse	(0-20.0)s	0.2	It is the speed-drop pulse output time, when the unit enters the stop idling.
93(88)	Fuel Level Low Shutdown	(0-100)%	5	When fuel level of external level sensor falls below the setting limit and lasts for 5s, low fuel level shutdown alarm will be initiated; if limit value set as 0, low fuel shutdown alarm will not be initiated.
94(89)	ATS Open Time	(1.0-60.0)s	3.0	ATS open output time.
95(90)	Gen PT Fitted	(0-1)	0	0: Disabled; 1: Enabled. PT primary and secondary voltage can be set.
96(91)	Mains PT Fitted	(0-1)	0	0: Disabled; 1: Enabled. PT primary and secondary voltage can be set. HGM6110LT is reserved and without this settings.
97(92)	Network	(0-1)	0	0: Disabled; 1: Enabled. ETHERNET port is enabled or not.
98(93)	Cloud Monitoring Setting	(0-1)	0	0: Disabled; 1: Enabled. Controller is allowed to connect with cloud monitoring platform.
99(94)	TCP/IP Modbus Setting	(0-1)	0	0: Disabled; 1: Enabled. Controller is allowed to connect with PC software via ETHERNET interface.
100(95)	Auto Obtain IP Address	(0-1)	0	0: Disabled; 1: Enabled. Controller is allowed to use dynamic assigned IP address, and fixed IP is unavailable.
101(96)	IP Address	192.168.0.100		All Ethernet settings change (e.g. IP address, subnet mask) are valid after re-power on.
102(97)	Subnet Mask	255.255.255.0		
103(98)	Default Gateway	192.168.0.2		
104(99)	DNS Address	211.138.24.66		
105(100)	Cooling Fan On Temp.	(0-255)	60	Unit: °C
106(101)	Cooling Fan Off Temp.	(0-255)	40	Unit: °C
107	Charger Voltage	(0-1)	0	0: Controller

No.	Items	Range	Default	Description
(102)	Sampling			1: ECU
108 (103)	Speed Sampling Selection	(0-1)	1	0: Controller 1: ECU
109 (104)	Temp. Sampling Selection	(0-1)	1	0: Controller 1: ECU
110 (105)	OP Sampling Selection	(0-1)	1	0: Controller 1: ECU
111 (106)	ECU Shutdown Setting	(0-1)	1	0: Enabled 1: Disabled
112 (107)	Low Oil Level Shutdown	(0-1)	0	0: Enabled 1: Disabled
113 (108)	Idle Speed	(0-6000)	1400	Unit: RPM
114 (109)	Rated Speed	(0-6000)	2250	Unit: RPM
115 (110)	ECU Address	(0-0xFF)	33	Set in hexadecimal display (0x21).
116 (111)	Over Current Protection Action	(0-2)	1	0: Inactive 1: Warn 2: Shutdown Alarm
117 (112)	Short-circuit Protection Setting Enabled	(0-1)	1	1: Enabled 0: Disabled
118 (113)	Short-circuit Protection Action	(0-2)	1	0: Inactive 1: Warn 2: Shutdown Alarm
119 (114)	Short-circuit Protection Threshold	(0-1000)	600	Unit: Ampere (A)
120 (115)	Short-circuit Protection Time Ratio	(0-30)	10	
121 (116)	Input Port 1 Action Type	(0-2)	1	0: Inactive 1: Warn 2: Shutdown Alarm
122 (117)	Input Port 2 Action Type	(0-2)	1	0: Inactive 1: Warn 2: Shutdown Alarm
123 (118)	Input Port 3 Action Type	(0-2)	1	0: Inactive 1: Warn 2: Shutdown Alarm
124 (119)	Input Port 4 Action Type	(0-2)	1	0: Inactive 1: Warn 2: Shutdown Alarm

No.	Items	Range	Default	Description
125 (120)	Input Port 5 Action Type	(0-2)	1	0: Inactive 1: Warn 2: Shutdown Alarm
126 (121)	Input Port 1 Action Range	(0-3)	1	0: Normal Running Start 1: Start 2: Always 3: Inactive
127 (122)	Input Port 2 Action Range	(0-3)	1	0: Normal Running Start 1: Start 2: Always 3: Inactive
128 (123)	Input Port 3 Action Range	(0-3)	1	0: Normal Running Start 1: Start 2: Always 3: Inactive
129 (124)	Input Port 4 Action Range	(0-3)	1	0: Normal Running Start 1: Start 2: Always 3: Inactive
130 (125)	Input Port 5 Action Range	(0-3)	1	0: Normal Running Start 1: Start 2: Always 3: Inactive

**NOTE1:** The value in first line of "Number" column is for HGM6120LT and the value in brackets is for HGM6110LT.

**NOTE2:** Cloud service related configuration needs to be set through PC software.

**NOTE3:** If select high temperature inhibit, or set programmable input as "High Temperature Inhibit" (this input is active), when temperature is higher than pre-setting threshold, controller sends warning signal only and not shutdown.

**NOTE4:** If select low oil pressure inhibit, or set programmable input as "Low Oil Pressure Inhibit" (this input is active), when low oil pressure is lower than pre-setting threshold, controller sends warning signal only and not shutdown.

**NOTE5:** If default password (0318) isn't changed, it doesn't need to input when configuring parameters via PC software; if the password is changed for the first time via PC software, it need to input password in password window.

**NOTE6:** Between input correct password and LCD back light haven't got dark, input parameter numbers can enter parameter setting interface when enters "Password Input" again.

**NOTE7:** In teeth configuration interface, if being in teeth configuration status and frequency is larger than 20Hz, press start key for auto calculating teeth numbers and press confirm key for changing teeth numbers.

**7.2 DEFINED CONTENTS OF AUXILIARY OUTPUTS 1-4**

**Table 8 – Defined Contents of Auxiliary Outputs 1-4**

No.	Items	Description
0	Not Used	Output is disabled when this item is selected.
1	Common Alarm	Including all shutdown alarm and warning alarm. When a warning alarm occurs, the alarm won't self-latch; When a shutdown alarm occurs, the alarm will self-latch until alarm is reset.
2	Energize to Stop	Used for the genset with stop solenoid. Pick-up when idle speed is over while disconnect when ETS delay is over.
3	Idle Control	Used for the genset with idle speed. Pick-up when crank while disconnect when enter into warming up. Pick-up when stop idle while disconnect when genset stop completely.
4	Preheat Control	Close before started and disconnect before powered on.
5	Gen Close Output	When close time is set as 0, it is continuous closing.
6	Mains Close Output	<b>HGM6110LT</b> without.
7	Open Breaker	When close time is set as 0, open breaker is disabled.
8	Rise Speed	Pick-up when enter into warming up time. Disconnect when raise speed auxiliary input active.
9	Drop Speed	Pick-up when enter into stop idle or ETS solenoid stop (shutdown alarm). Disconnect when drop speed auxiliary input active.
10	Generator Run	Output when genset is in normal running, disconnect when rotating speed is lower than engine speed after fired.
11	Fuel Pump Control	Pick-up when the fuel level lower than the open threshold or low fuel level warning is active; disconnect when the fuel level over the close threshold and the low fuel level warning input is disabled.
12	High Speed Control	Output when it enters into warming up time, and disconnect after cooling.
13	In Auto Mode	The controller is in Auto Mode.
14	Shutdown Alarm	Output when shutdown alarm occurs and open when alarm resets.
15	Audible Alarm	When shutdown alarm and warn alarm occur, audible alarm is set as 300s. In audible alarm output duration, when panel any key or "alarm mute" input is active, it can remove the alarm.
16	Heater Control	It is controlled by heater of temperature sensor's limited threshold.
17	Fuel Output	Action when genset is starting and disconnect when stop is completed.
18	Crank Output	Genset output in start output status and open in other status.
19	ECU Stop	Used for ECU engine and control its stop.
20	ECU Power	Used for ECU engine and control its power.
21	ECU Warn	Indicate ECU sends a warning signal.
22	ECU Shutdown	Indicate ECU sends a shutdown signal.
23	ECU Comm. Failure	Indicate controller not communicates with ECU.

No.	Items	Description
24	Raise Speed Pulse	Raising speed time is output while the unit entering into hi-speed warming up.
25	Drop Speed Pulse	Dropping speed time is output while the unit entering into stop idling.
26	Oil Pump Control	Engine type select Yuchai-LMB. When unit is standby, pump control output per 30 minutes. If oil pressure is above 100kPa or output delay is more than 1 minute, it will stop output; if unit is in re-heating state, oil pump control will always output.

### 7.3 DEFINED CONTENTS OF AUXILIARY INPUTS 1-5

**Table 9 – Defined Contents of Auxiliary Input 1-5 (All GND(B-) Connected Active)**

No.	Items	Description
0	Not Used	
1	High Temperature Shutdown	If the signal is active after safety run on delay over, genset will immediately alarm to shut down.
2	Low Oil Pressure Shutdown	
3	Warn Input	Only warning, not shutdown if input is active.
4	Shutdown Input	If the signal is active, genset will immediately alarm to shut down.
5	WTH STOP by Cool	During engine running and the input is active, if high temperature occurs, controller will stop after high speed cooling; when the input is disabled, controller will stop immediately.
6	Generator Close Status	Connect to auxiliary port of gen load breaker.
7	Mains Close Status	Connect to auxiliary port of mains load breaker.
8	Inhibit WTH STOP	When it is active, high temperature stop is inhibited. See <b>NOTE 3 of Table 8</b> for more information.
9	Inhibit OPL STOP	When it is active, low oil pressure stop is inhibited. See <b>NOTE 4 of Table 8</b> for more information.
10	Remote Start	In <b>Auto</b> mode, when input active, genset can be started and with load after genset is OK; when input inactive, genset will stop automatically.
11	Low Fuel Level Warn	Connected to sensor digital input. The controller sends a warning alarm signal when active.
12	Low Coolant Level Warn	
13	Low Fuel Level Shutdown	Connected to sensor digital input. The controller sends a shutdown alarm signal when active.
14	Low Coolant Level Shutdown	
15	Inhibit Start Auto	In Auto Mode, when the input is active, no matter mains normal or not, genset won't start. If genset is in normal running, stop process won't be executed. When input is disabled, genset will automatically start or stop judging by mains normal or not.
16	Remote Control	All keys in panel is inactive except     and

No.	Items	Description
		"Remote Mode" is displayed on LCD. Remote module can switch module mode and start/stop operation via panel buttons.
17	Charge Alt Fail IN	Connect to "failed to charge output" of the charger.
18	Panel Lock	All buttons in panel is inactive except     and there is  in the right of fifth row in LCD when input is active.
19	Alarm Mute	Can prohibit "Audible Alarm" output when input is active.
20	Idle Control Mode	In this mode, under voltage, under frequency and under speed are not protected.
21	60Hz Active	It is used for J1939 engine with CANBUS port, when input is active, frequency is 60Hz.
22	Raise Speed Pulse	If engine type is common J1939, when input is active, engine target speed will increase 50r/min.
23	Drop Speed Pulse	If engine type is common J1939, when input is active, engine target speed will decrease 50r/min.
24	Instrument Mode	All the outputs are prohibited in this mode.
25	Manual Mode Input	In manual mode, genset can be started automatically when input is active; genset can be stopped automatically when input is inactive.
26	Auto Mode Input	In auto mode, genset can be started automatically when input is active, genset is loaded after normal running and the mains is unloaded. The genset will be stopped automatically when input is inactive, the mains is loaded and genset is unloaded.
27	Simulate Start Button	Can connect an external button (non-locking) to simulate the panel button.
28	Simulate Stop Button	Can connect an external button (non-locking) to simulate the panel button.
29	Simulate Generation & Open Button	Can connect an external button (non-locking) to simulate the panel button.
30	Simulate Mains & Open Button	Can connect an external button (non-locking) to simulate the panel button.
31	Combat Mode	Except for emergency shutdown, all other shutdown alarms are prohibited.(Combat mode or override mode)
32	ECU Shutdown Alarm Disabled	Input port is enabled, the controller will not receive the ECU shutdown alarms and will not initiate shutdown signal.
33	User Configured	The action type, range and delay time can be selected in this state. When the input port is active, the controller will execute the related actions of the input port according to the selected action range.



**7.4 SENSOR SELECTION**

**Table 10 – Sensors Selection**

No.	Items	Content	Description
1	Temperature Sensor	0 Not used 1 User Configured (Resistance Type) 2 VDO 3 SGH 4SGD 5 CURTIS 6 DATCON 7 VOLVO-EC 8 SGX 9 User Configured (4-20)mA 10 User Configured (0-5)V 11 Digital Closed 12 Digital Open 13 Reserved 14 Reserved	Defined input resistance range is 0Ω~6000Ω, factory default is SGD sensor.
2	Pressure Sensor	0 Not used 1 User Configured (Resistance Type) 2 VDO 10Bar 3 SGH 4 SGD 5 CURTIS 6 DATCON 10Bar 7 VOLVO-EC 8 SGX 9 User Configured (4-20)mA 10 User Configured (0-5)V 11 Digital Closed 12 Digital Open 13 VDO 5Bar 14 Reserved	Defined input resistance range is 0Ω~6000Ω, factory default is SGD sensor.
3	Fuel Level Sensor	0 Not used 1 User Configured (Resistance Type) 2 SGH 3 SGD 4 User Configured (4-20)mA 5 User Configured (0-5)V 6 Digital Closed 7 Digital Open	Defined input resistance range is 0Ω~6000Ω, factory default is SGD sensor.

**NOTE:** It needs special instructions for ordering when the genset uses (4-20)mA or (0-5)V sensor.



**7.5 CONDITIONS OF CRANK DISCONNECT SELECTION**

**Table 11 – Crank Disconnect Conditions Selection**

No.	Content
0	Speed
1	Generator frequency
2	Speed + Generator frequency
3	Speed + Oil pressure
4	Generator frequency + Oil pressure
5	Generator frequency + Speed + Oil pressure
6	Oil pressure

- 1) There are 3 kinds of crank disconnect conditions. Speed, generator frequency and oil pressure can be used alone. Oil pressure is used with speed and the generator frequency together is recommended, in order to make the starter and the engine disconnect as soon as possible.
- 2) Speed is the signal measured by magnetic sensor, which is installed in the engine for testing flywheel teeth.
- 3) When choosing speed, ensure the number of flywheel teeth is same as the pre-set, otherwise over or under speed shutdown may appear.
- 4) If generator has no magnetic pickup sensor, don't choose speed item; otherwise Fail to Start or Loss of Speed Signal shutdown will occur.
- 5) If the generator has no oil pressure sensor, don't choose corresponding item.
- 6) If generator frequency has not been selected, controller will not measure and display the relative parameters (can be applied to the pump set); if speed has not been selected, the speed will be calculated by the generating signal.

## 8 PARAMETER SETTING

After controller is powered on, press  to enter into the parameters setting menu:

1. Set Parameters
2. Information
3. Set Language
4. Event Log
5. ECU DM2
6. Maintenance

### — Parameters Setting

All items in table7 can be set after inputting password “0318”. When the default password has been changed, it needs to input the same password with controller for parameter setting via PC software. If more parameter items need to be set or password is forgotten, such as voltage and current calibration, please contact with the factory.

#### ▲NOTE:

- 1) **HGM6110LT**, there are no items 1-5 in table7; programmable output 1-4 have no digital outputs about mains.
- 2) Please modify the internal parameters in standby mode (crank conditions, auxiliary input and output configuration, multi delays, etc.) otherwise shutdown alarm or other abnormal conditions may appear.
- 3) The over-voltage threshold must be greater than the under-voltage threshold; otherwise over-voltage and under-voltage will occur at the same time.
- 4) The over-speed threshold must be greater than under-speed threshold, otherwise over speed and under speed will occur at the same time.
- 5) Set frequency value (after crank disconnect) as low as possible, in order to disconnect starter quickly.
- 6) Programmable input 1-5 cannot be set as the same items, otherwise it cannot realize correct function; programmable output 1-4 can be set as the same item.
- 7) If need to shut down after cooling, please set any input as “stop after cooling”, then connect this input to ground; or set high temperature stop action as “cooling stop”

### — Information





- 1) LCD will display some information of controller, such as software version, issue date.

▲NOTE: Pressing  will display the status of digital inputs and outputs.

- 2) Language

User may select display language as Chinese, English, Spanish, Russian, Portuguese, Turkish, Polish and French.

- 3) LCD contrast

Press  and  (or  and ) can adjust LCD contrast to make LCD characters clearer.

Adjustment range is 0-7.

**9 SENSOR SETTING**

- When choosing sensor, standard of sensor curve will be needed. If temperature sensor is set as SGH (120°C resistor type), sensor curve should be SGH (120°C resistor type); If it is set as SGD (120°C resistor type), sensor curve should be SGD curve.
- If there is difference between standard sensor curve and chosen sensor curve, select “defined sensor”, and then input defined sensor curve.
- When sensor curve is inputted, X value (resistance) must be in accordance with the order of higher to lower, otherwise errors will occur.
- When sensor is selected as “Not used”, temperature, pressure and fuel level will be display as “- - -” in LCD.
- If there is no pressure sensor, but only has low pressure alarm switch, then you must set pressure sensor as “Not used”, otherwise oil pressure low alarm shutdown may appear.
- Can set several points of forehead or backmost as the same ordinate, as the following picture:

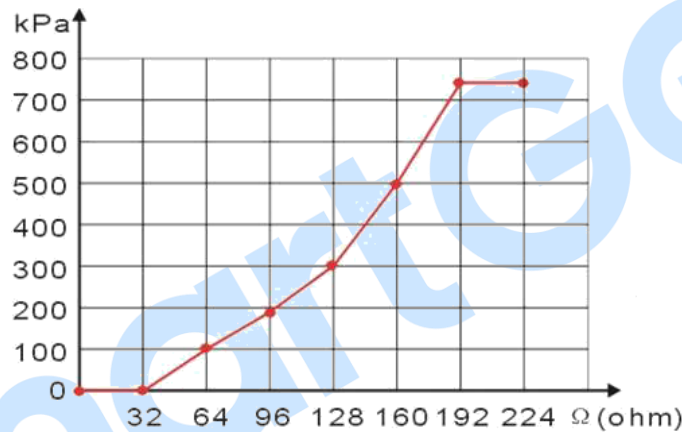

**Fig.4 – Sensor Curve**

**Table 12 – Conventional Pressure Unit Conversion Table**

	N/m <sup>2</sup> (pa)	kgf/cm <sup>2</sup>	bar	psi
1Pa	1	1.02x10 <sup>-5</sup>	1x10 <sup>-5</sup>	1.45x10 <sup>-4</sup>
1kgf/cm <sup>2</sup>	9.8x10 <sup>4</sup>	1	0.98	14.2
1bar	1x10 <sup>5</sup>	1.02	1	14.5
1psi	6.89x10 <sup>3</sup>	7.03x10 <sup>-2</sup>	6.89x10 <sup>-2</sup>	1

---

## 10 COMMISSIONING

Before operation, the following checking should be carried out:

- Check and ensure all the connections are correct and wires diameter is suitable.
- Ensure that the controller DC power has fuse; starting battery positive and negative have correctly connected.
- Emergence stop input must be connected to positive of starting battery via normally close contact of emergency stop.
- Take proper actions to prevent engine to disconnect crank (e. g. Remove the connections of fuel valve). If checking is OK, connect start battery, select Manual Mode, controller will execute the program.
- Set controller as Manual Mode, press “start” button to start genset. If failed within the setting crank times, controller will send “Failed to Start” signal; then press “stop” to reset controller.
- Recover actions of preventing engine to disconnect crank (e. g. Connect wire of fuel valve), press “start” button again, genset will start. If everything goes well, genset will normal run after idle running (if configured). During this period, watch for engine’s running situations and voltage and frequency of alternator. If there is abnormal, stop genset and check all connections according to this manual.
- Select the Auto Mode from front panel, connect to mains signal. After the mains normal delay, controller will transfer ATS (if configured) into mains load. After cooling, controller will stop genset and into standby state until mains abnormal again.
- When mains abnormal again, genset will start automatically and into normal running, send signal to make gens close, transfer ATS and make genset take load. If it not likes this, please check connections of ATS according to this manual.
- If there are any other questions, please contact SmartGen’s service.

**11 TYPICAL APPLICATION**

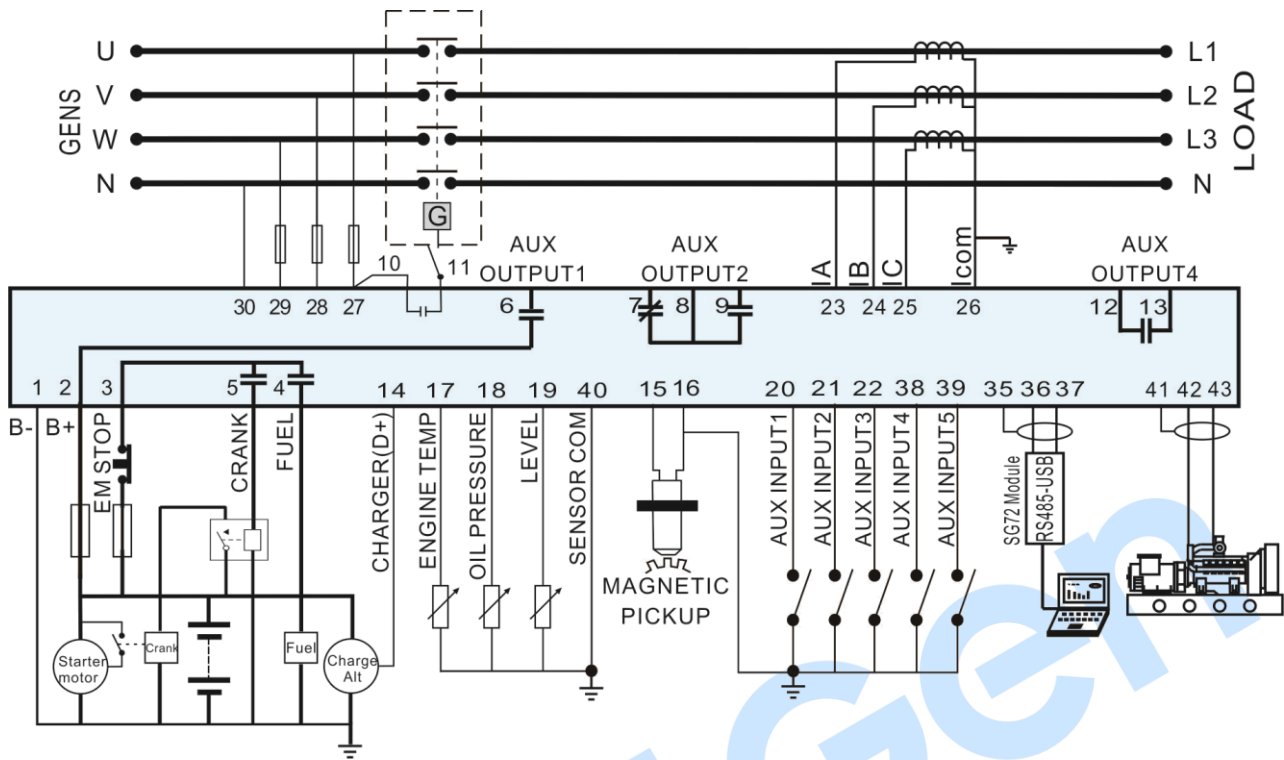

**Fig.5 - HGM6110LT Typical Application Diagram**

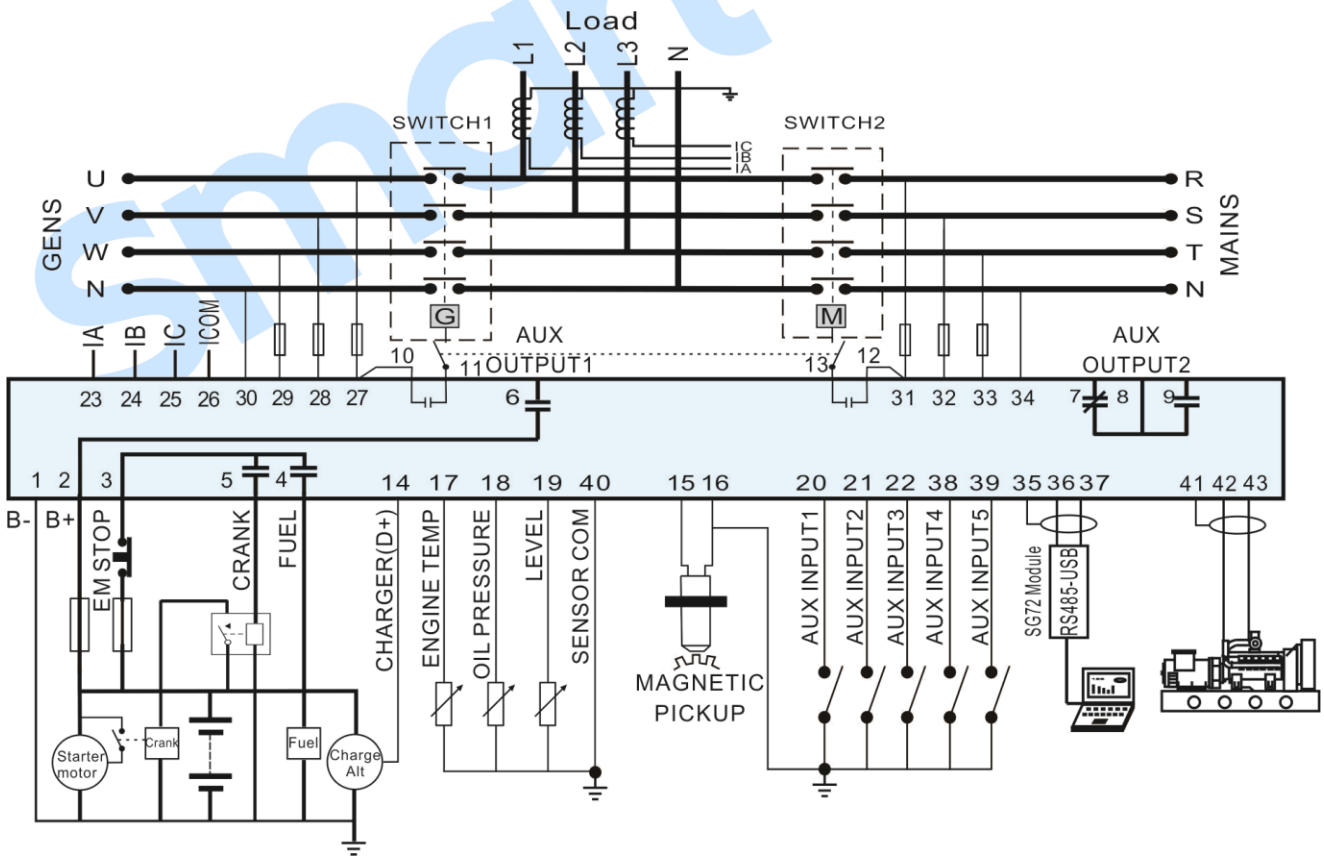

**Fig.6 - HGM6120LT Typical Application Diagram**

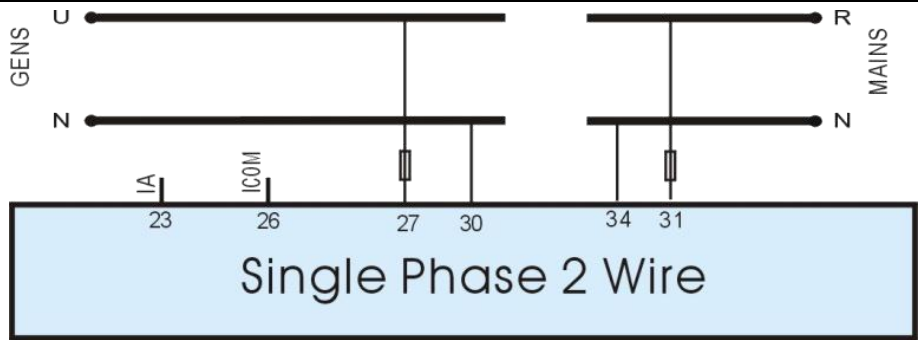

**Fig.7 – Single Phase 2 Wire Connection Diagram**

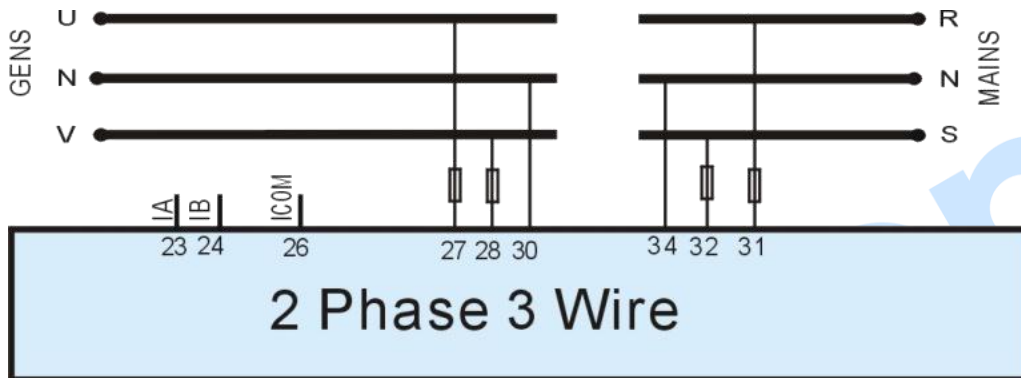

**Fig.8 – 2 Phase 3 Wire Connection Diagram**

**▲NOTE:** Recommend that the output of crank and fuel expand high capacity relay.

## 12 INSTALLATION

### 12.1 FIXING CLIPS

- The module is held into the panel fascia using the supplied fixing clips.
- Withdraw the fixing clip screw (turn anticlockwise) until it reaches proper position.
- Pull the fixing clip backwards (towards the back of the module) ensuring four clips are inside their allotted slots.
- Turn the fixing clip screws clockwise until they make contact with the panel.

**▲NOTE:** Care should be taken not to over tighten the screws of fixing clips.

### 12.2 OVERALL DIMENSION AND PANEL CUTOUT

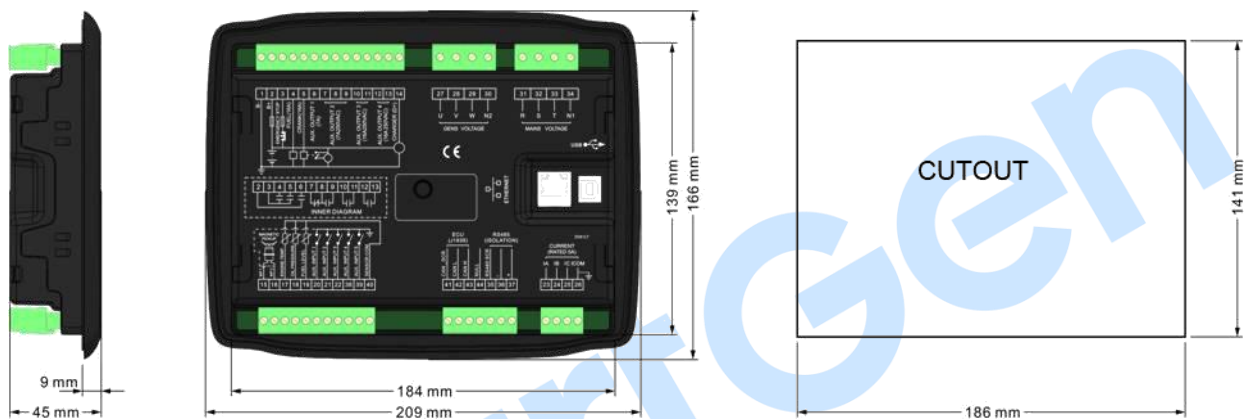

**Fig.9 – Case and Overall Dimensions**

HGM6100LT series controller can be applicable to (8~35) VDC battery voltage. Battery negative must be reliably connected to engine shell. The connection between controller power (B+ and B-) and battery (B+ and B-) should not be less than 2.5mm<sup>2</sup>. If a floating charger is fitted, please connect output line of the charger with battery directly, and then connect battery positive and negative to power input of controller separately, in case that charger will interfere with the normal running of controller.

#### 1) **Speed Sensor Input**

Speed sensor is installed in the engine for testing flywheel teeth. The connection with controller uses 2-core screen, shield layer should be connected to terminal 16 of controller and the other end vacant. The other two signal lines are respectively connected to terminal 15 and terminal 16. At full speed, output voltage range is (1~24) VAC (RMS), 12VAC is recommended (rated speed). During installing, make the speed sensor contact the flywheel firstly, then pour out 1/3 laps, finally lock nut on the sensor.

#### 2) **Output and Expansion Relay**

All the outputs of controller are relay output. If need to expand relay, please add freewheeling diode in both ends of relay coil (when expansion relay coil links DC), or add RC loop (when expansion relay coil links AC), in case interfering controller or other equipment.

#### 3) **AC Input**

HGM6100LT series controller must externally connect to current transformer; CT secondary current must be 5A. Besides, the phase of CT and input voltage must be correct, or the sampling current and active power may be incorrect.

- ▲NOTE:** a. Icom must connect to battery cathode of the controller.  
b. When there is load current, open circuit is inhibited in the CT secondary side.

**5) Withstand Voltage Test**

When the controller has been installed in the control panel, during the test please disconnect all the terminals, in case high voltage damages the controller.

SmartGen



## 13 CONNECTIONS OF CONTROLLER WITH J1939 ENGINE

### 13.1 CUMMINS ISB/ISBE

**Table 13 – Connector B**

Terminals of controller	Connector B	Remark
Programmable output 1	39	Set programmable output 1 as "Fuel Output".
Starting relay output	-	Connect with starter coil directly.
Programmable output 2	Expand 30A relay, battery voltage of 01, 07, 12, 13 is supplied by relay.	ECU power; Set programmable output 2 as "ECU power".

**Table 14 – 9 Pins Connector**

Terminals of controller	9 pins connector	Remark
CAN_SCR	SAE J1939 shield	CAN communication shielding line (connect to ECU terminal only).
CAN(H)	SAE J1939 signal	Using impedance 120Ω connecting line.
CAN(L)	SAE J1939 return	Using impedance 120Ω connecting line.

**Engine type:** Cummins ISB.

### 13.2 CUMMINS QSL9

Suitable for CM850 engine control module.

**Table 15 – 50 Pins Connector**

Terminals of controller	50 pins connector	Remark
Programmable output 1	39	Set programmable output 1 as "Fuel Output".
Starting relay output	-	Connect to starter coil directly.

**Table 16 – 9 Pins Connector**

Terminals of controller	9 pins connector	Remark
CAN_SCR	SAE J1939 shield-E	CAN communication shielding line (connect to ECU terminal only).
CAN(H)	SAE J1939 signal-C	Using impedance 120Ω connecting line.
CAN(L)	SAE J1939 return-D	Using impedance 120Ω connecting line.

**Engine type:** Cummins-CM850.

### 13.3 CUMMINS QSM11 (IMPORT)

It is suitable for CM570 engine control module. Engine type is QSM11 G1, QSM11 G2.

**Table 17 – C1 Connector**

Terminals of controller	C1 connector	Remark
Programmable output 1	5&8	Set programmable output 1 as "Fuel Output". Outside expand relay, when fuel output, making make port 5 and port 8 of C1 be connected.
Starting relay output	-	Connect to starter coil directly.

**Table 18 – 3 Pins Data Link Connector**

Terminals of controller	3 pins data link connector	Remark
CAN_SCR	C	CAN communication shielding line (connect to ECU terminal only).
CAN(H)	A	Using impedance 120Ω connecting line.
CAN(L)	B	Using impedance 120Ω connecting line.

**Engine type:** Cummins ISB.

### 13.4 CUMMINS QSX15-CM570

It is suitable for CM570 engine control module. Engine type is QSX15.

**Table 19 – 50 Pins Connector**

Terminals of controller	50 pins connector	Remark
Programmable output 1	38	Oil spout switch; Set programmable output 1 as "Fuel Output".
Starting relay output	-	Connect to starter coil directly

**Table 20 – 9 Pins Connector**

Terminals of controller	9 pins connector	Remark
CAN_SCR	SAE J1939 shield-E	CAN communication shielding line (connect to ECU terminal only).
CAN(H)	SAE J1939 signal-C	Using impedance 120Ω connecting line.
CAN(L)	SAE J1939 return-D	Using impedance 120Ω connecting line.

**Engine type:** Cummins QSX15-CM570.

### 13.5 CUMMINS GCS-MODBUS

It is suitable for GCS engine control module. Use RS485-MODBUS to read information of engine. Engine types are QSX15, QST30, QSK23/45/60/78 and so on.

**Table 21 – D-SUB Connector 6**

Terminals of controller	D-SUB connector 06	Remark
Programmable output 1	5&8	Set programmable output 1 as “Fuel Output”. Outside expand relay, when fuel output, connect port 06 and 08 of the connector.
Starting relay output	-	Connect to starter coil directly.

**Table 22 – D-SUB Connector 06**

Terminals of controller	D-SUB connector 06	Remark
RS485 GND	20	CAN communication shielding line (connect to ECU terminal only).
RS485+	21	Using impedance 120Ω connecting line.
RS485-	18	Using impedance 120Ω connecting line.

**Engine type:** Cummins QSK-MODBUS, Cummins QST-MODBUS, Cummins QSX-MODBUS.

### 13.6 CUMMINS QSM11

**Table 23 – Engine OEM Connector**

Terminals of controller	OEM connector of engine	Remark
Programmable output 1	38	Set programmable output 1 as “Fuel Output”.
Starting relay output	-	Connect with starter coil directly.
CAN_SCR	-	CAN communication shielding line.
CAN(H)	46	Using impedance 120Ω connecting line.
CAN(L)	37	Using impedance 120Ω connecting line.

**Engine type:** common J1939.

**13.7 CUMMINS QSZ13**

**Table 24 – Engine OEM Connector**

Terminals of controller	OEM connector of engine	Remark
Programmable output 1	45	
Starting relay output	-	Connect to starter coil directly.
Programmable output 2	16&41	Setting to idle speed control, normally open output. Making 16 connect to 41 during high-speed running of controller via external expansion relay.
Programmable output 3	19&41	Setting to pulse raise speed control, normally open output. Making 19 connect with 41 for 0.1s during high-speed warming of controller via external expansion relay.
CAN_SCR	-	CAN communication shielding line.
CAN(H)	1	Using impedance 120Ω connecting line.
CAN(L)	21	Using impedance 120Ω connecting line.

**Engine type:** Common J1939.

**13.8 DETROIT DIESEL DDEC III / IV**

**Table 25 – Engine CAN Port**

Terminals of controller	CAN port of engine	Remark
Programmable output 1	Expand 30A relay, battery voltage is supplied by relay.	Set programmable output 1 as “Fuel Output”.
Starting relay output	-	Connect to starter coil directly.
CAN_SCR	-	CAN communication shielding line.
CAN(H)	CAN(H)	Using impedance 120Ω connecting line.
CAN(L)	CAN(L)	Using impedance 120Ω connecting line.

**Engine type:** common J1939.

### 13.9 DEUTZ EMR2

**Table 26 – F Connector**

Terminals of controller	F connector	Remark
Programmable output 1	Expand 30A relay, battery voltage of 14 is supplied by relay. Fuse is 16A.	Set programmable output 1 as "Fuel Output".
Starting relay output	-	Connect to starter coil directly.
-	1	Connect to battery negative pole.
CAN_SCR	-	CAN communication shielding line.
CAN(H)	12	Using impedance 120Ω connecting line.
CAN(L)	13	Using impedance 120Ω connecting line.

**Engine type:** Volvo EDC4.

### 13.10 JOHN DEERE

**Table 27 – 21 Pins Connector**

Terminals of controller	21 pins connector	Remark
Programmable output 1	G, J	Set programmable output 1 as "Fuel Output".
Starting relay output	D	
CAN_SCR	-	CAN communication shielding line.
CAN(H)	V	Using impedance 120Ω connecting line.
CAN(L)	U	Using impedance 120Ω connecting line.

**Engine type:** John Deere.

### 13.11 MTU MDEC

Suitable for MTU engines, 2000 series, 4000 series.

**Table 28 – X1 Connector**

Terminals of controller	X1 connector	Remark
Programmable output 1	BE1	Set programmable output 1 as "Fuel Output".
Starting relay output	BE9	
CAN_SCR	E	CAN communication shielding line (connect to one terminal only).
CAN(H)	G	Using impedance 120Ω connecting line.
CAN(L)	F	Using impedance 120Ω connecting line.

**Engine type:** MTU-MDEC.

### 13.12 MTU ADEC (SMART MODULE)

It is suitable for MTU engine with ADEC (ECU8) and SMART module.

**Table 29 – ADEC (X1 port)**

Terminals of controller	ADEC (X1 port)	Remark
Programmable output 1	X1 10	Set programmable output 1 as "Fuel Output". X1 Terminal 9 Connected to negative of battery.
Starting relay output	X1 34	X1 Terminal 33 Connected to negative of battery.

**Table 30 – SMART (X4 port)**

Terminals of controller	SMART (X4 port)	Remark
CAN_SCR	X4 3	CAN communication shielding line.
CAN(H)	X4 1	Using impedance 120Ω connecting line.
CAN(L)	X4 2	Using impedance 120Ω connecting line.

**Engine type:** MTU-ADEC.

### 13.13 MTU ADEC (SAM MODULE)

It is suitable for MTU engine with ADEC (ECU7) and SAM module.

**Table 31 – ADEC (X1 port)**

Terminals of controller	ADEC (X1 port)	Remark
Programmable output 1	X1 43	Set programmable output 1 as "Fuel Output". X1 Terminal 28 Connected to negative of battery.
Starting relay output	X1 37	X1 Terminal 22 Connected to negative of battery.

**Table 32 – SAM (X23 port)**

Terminals of controller	SAM (X23 port)	Remark
CAN_SCR	X23 3	CAN communication shielding line.
CAN(H)	X23 2	Using impedance 120Ω connecting line.
CAN(L)	X23 1	Using impedance 120Ω connecting line.

**Engine type:** Common J1939.

### 13.14 PERKINS

It is suitable for ADEM3/ADEM4 engine control mode. Engine type is 2306, 2506, 1106, and 2806.

**Table 33 – Connector**

Terminals of controller	Connector	Remark
Programmable output 1	1, 10, 15, 33, 34	Set programmable output 1 as "Fuel Output".
Starting relay output	-	Connect to starter coil directly.
CAN_SCR	-	CAN communication shielding line.
CAN(H)	31	Using impedance 120Ω connecting line.
CAN(L)	32	Using impedance 120Ω connecting line.

**Engine type:** Perkins.

### 13.15 SCANIA

It is suitable for S6 engine control mode. Engine type is DC9, DC12, and DC16.

**Table 34 – B1 Connector**

Terminals of controller	B1 connector	Remark
Programmable output 1	3	Set programmable output 1 as "Fuel Output".
Starting relay output	-	Connect to starter coil directly.
CAN_SCR	-	CAN communication shielding line.
CAN(H)	9	Using impedance 120Ω connecting line.
CAN(L)	10	Using impedance 120Ω connecting line.

**Engine type:** Scania.

### 13.16 VOLVO EDC3

Suitable engine control model is TAD1240, TAD1241, and TAD1242.

**Table 35 – "Stand alone" Connector**

Terminals of controller	"Stand alone" connector	Remark
Programmable output 1	H	Set programmable output 1 as "Fuel Output".
Starting relay output	E	
Programmable output 2	P	ECU power; Set programmable output 2 as "ECU power".

**Table 36 – “Data bus” Connector**

Terminals of controller	“Data bus” connector	Remark
CAN_SCR	-	CAN communication shielding line.
CAN(H)	1	Using impedance 120Ω connecting line.
CAN(L)	2	Using impedance 120Ω connecting line.

**Engine type:** Volvo.

**▲NOTE:** When this engine type is selected, preheating time should be set to at least 3 seconds.

### 13.17 VOLVO EDC4

Suitable engine types are TD520, TAD520 (optional), TD720, TAD720 (optional), TAD721, TAD722, and TAD732.

**Table 37 – Connector**

Terminals of controller	Connector	Remark
Programmable output 1	Expanded 30A relay, and relay offers battery voltage to terminal 14. Fuse is 16A.	Set programmable output 1 as “Fuel Output”.
Starting relay output	-	Connect to starter coil directly.
	1	Connected to negative of battery.
CAN_SCR	-	CAN communication shielding line.
CAN(H)	12	Using impedance 120Ω connecting line.
CAN(L)	13	Using impedance 120Ω connecting line.

**Engine type:** Volvo EDC4.

### 13.18 VOLVO-EMS2

Volvo Engine types are TAD734, TAD940, TAD941, TAD1640, TAD1641, and TAD1642.

**Table 38 – Engine CAN Port**

Terminals of controller	Engine’s CAN port	Remark
Programmable output 1	6	ECU stop; Programmable output 1 “ECU stop”.
Programmable output 2	5	ECU power; Programmable output 2 “ECU power”.
	3	Negative power.
	4	Positive power.
CAN_SCR	-	CAN communication shielding line.
CAN(H)	1(Hi)	Using impedance 120Ω connecting line.
CAN(L)	2(Lo)	Using impedance 120Ω connecting line.

**Engine type:** Volvo-EMS2.

**▲NOTE:** When this engine type is selected, preheating time should be set to at least 3 seconds.



### 13.19 YUCHAI

It is suitable for Yuchai BOSCH common rail electronic-controlled engine.

**Table 39 – Engine 42 Pins Port**

Terminals of controller	Engine 42 pins port	Remark
Programmable output 1	1.40	Set programmable output 1 as “Fuel Output”; Connect to engine ignition lock.
Starting relay output	-	Connect to starter coil directly.
CAN_SCR	-	CAN communication shielding line.
CAN(H)	1.35	Using impedance 120Ω connecting line.
CAN(L)	1.34	Using impedance 120Ω connecting line.

**Table 40 – Engine 2 Pins Port**

Battery	Engine 2 pins port	Remark
Battery negative	1	Wire diameter 2.5mm <sup>2</sup> .
Battery positive	2	Wire diameter 2.5mm <sup>2</sup> .

**Engine type:** BOSCH.

### 13.20 WEICHAI

It is suitable for Weichai BOSCH common rail electronic-controlled engine.

**Table 41 – Engine Port**

Terminals of controller	Engine port	Remark
Programmable output 1	1.40	Set programmable output 1 as “Fuel Output”; Connect to engine ignition lock.
Starting relay output	1.61	
CAN_SCR	-	CAN communication shielding line.
CAN(H)	1.35	Using impedance 120Ω connecting line.
CAN(L)	1.34	Using impedance 120Ω connecting line.

**Engine type:** GTSC1.

**▲NOTE:** If there is any question of connection between controller and ECU communication, please feel free to contact SmartGen service.

**14 FAULT FINDING**

**Table 42 – Fault Finding**

Symptoms	Possible Solutions
Controller No Response with Power	Check starting battery; Check connections of controller; Check the DC fuse.
Genset Shutdown	Check if water/cylinder temperature too high; Check alternator voltage; Check the DC fuse.
Controller Emergency Stop	Check if an emergency stop button is fitted; Ensure battery positive is connected to the emergency stop input; Check if connection is open circuit.
Low Oil Pressure Alarm (After Crank Disconnect)	Check oil pressure sensor and connections.
High Water Temp. Alarm (After Crank Disconnect)	Check water temperature sensor and connections.
Shutdown Alarm During Running	Check switch and connections according to information on LCD. Check configurable inputs.
Crank Disconnect Failure	Check connections of fuel solenoid; Check starting battery; Check speed sensor and its connections; Refer to engine manual.
Starter No Response	Check connections of starter; Check starting battery.
Genset Running while ATS Not Transfer	Check ATS; Check connections between ATS and controller.
RS485 Failure	Check connections; Check if COM port is correct; Check if A and B of RS485 is connected reversely; Check if PC COM port is damaged; 120Ω resistance between RS485's A and B is recommended.
ECU Communication Failure	Check polarity connections between CAN_H and CAN_L; Check engine type settings; Check connections between controller and engine.
ETHERNET Interface Cannot Connect Cloud Platform	Check cloud server's domain name and port number; Check controller's IP and DNS address.