



SmartGen
ideas for power

HGM400N SERIES (HGM410N/HGM420N) GENSET CONTROLLER USER MANUAL



SMARTGEN (ZHENGZHOU) TECHNOLOGY CO.,LTD.



Chinese trademark

SmartGen English trademark

SmartGen — make your generator *smart*

SmartGen Technology Co., Ltd.

No.28 Jinsuo Road

Zhengzhou City

Henan Province

P. R. China

Tel: 0086-(0)371-67988888/67981888

0086-(0)371-67991553/67992951

0086-(0)371-67981000(overseas)

Fax: 0086-(0)371-67992952

Web: www.smartgen.com.cn

www.smartgen.cn

Email: sales@smartgen.cn

All rights reserved. No part of this publication may be reproduced in any material form (including photocopying or storing in any medium by electronic means or other) without the written permission of the copyright holder.

Applications for the copyright holder's written permission to reproduce any part of this publication should be addressed to SmartGen Technology at the address above.

Any reference to trademarked product names used within this publication is owned by their respective companies.

SmartGen Technology reserves the right to change the contents of this document without prior notice.

Table 1 Version History

Date	Version	Note
2016-08-01	1.0	Original release.
2017-03-29	1.1	Modify some details.
2017-04-21	1.2	Modify Storage Temperature and Operation Humidity.
2019-09-18	1.3	Fix a description.

CONTENTS

1	OVERVIEW	4
2	PERFORMANCE AND CHARACTERISTICS	4
3	SPECIFICATION	6
4	OPERATION	7
4.1	PUSHBUTTONS.....	7
4.2	INDICATOR LIGHT.....	8
4.3	AUTOMATIC START/STOP OPERATION	9
4.4	MANUAL START/STOP OPERATION	10
4.5	EMERGENCY START	10
5	PROTECTION.....	11
5.1	WARNINGS	11
5.2	SHUTDOWN ALARM	13
6	CONNECTIONS.....	16
7	DEFINITION AND RANGE OF PARAMETERS	18
7.1	PARAMETER CONTENTS AND RANGE	18
7.2	PROGRAMMABLE OUTPUT 1-5.....	26
7.3	PROGRAMMABLE INPUT 1-4 (ACTIVE WHEN CONNECT GND (B-)).....	27
7.4	SENSOR SELECT	28
7.5	CONDITIONS OF CRANK DISCONNECT	29
8	PARAMETERS SETTING.....	30
8.1	PARAMETER SETTINGS	30
8.2	CONTROLLER INFORMATION.....	30
8.3	LANGUAGE.....	31
8.4	EVENT LOG.....	31
8.5	MAINTENANCE SETTING.....	31
9	SENSOR SETTING	32
10	COMMISSIONING	33
11	TYPICAL APPLICATION.....	34
12	INSTALLATION	35
12.1	FIXING CLIPS	35
12.2	OVERALL DIMENSION AND PANEL CUTOUT	35
13	FAULT FINDING	37

1 OVERVIEW

HGM400N series genset controller integrates digitization, intelligentization and network technology together, and is used for single unit automation and monitoring control system, to achieve automatic start/stop, data measurement, alarm protection etc. functions. It fits with LCD display, optional language interface (Chinese, English, Spanish, Turkish, Russian and French). It is reliable and easy to operate.

HGM400N series genset controller adopts micro-processor technology, realizing precise parameter measuring, fixed value adjustment, time setting and set value adjusting etc. All parameters can be configured from front panel, or they can be modified and monitored through USB interface by using PC. It can be widely used in all types of automatic genset control system with compact structure, simple wirings and high reliability.

2 PERFORMANCE AND CHARACTERISTICS

HGM400N series controller has two types:

HGM410N: used for automation of single unit, which controls generator to start/stop by remote start signal.

HGM420N: based on HGM410N, AMF (Auto Mains Failure) and Mains/Gens automatic transfer control functions are added, which is especially suitable for single unit automation system composed by one mains and one genset.

Main characteristics are as below:

- 132x64 LCD with backlight, selectable language interface (Chinese, English, Spanish, Turkish, Russian and French), push-button operation;
- Improved LCD wear-resistance and scratch resistance due to hard screen acrylic;
- Silicon panel and pushbuttons for better operation in high/low temperature environment;
- Suitable for 3-phase 4-wire, 3-phase 3-wire, single phase 2-wire, and 2-phase 3-wire systems with voltage 120/240V and frequency 50/60Hz;
- Collects and shows 3-phase voltage, 3-phase current, power parameter and frequency of generator or mains.

Mains

Line Voltage (Uab, Ubc, Uca)

Phase Voltage (Ua, Ub, Uc)

Frequency (Hz)

Phase Sequence

Generator

Line Voltage (Uab, Ubc, Uca)

Phase Voltage (Ua, Ub, Uc)

Frequency (Hz)

Phase Sequence

Load

Current (IA, IB, IC)

Split-phase and Total Active Power (kW)

Reactive Power (kvar)

Apparent Power (kVA)

Power Factor (PF)

Accumulated Gen Energy (kWh)

Output Percentage with Load (%)

- For Mains, controller has over voltage, under voltage and loss of phase detection functions; For

generator, controller has over voltage, under voltage, over frequency, under frequency, over current and over power detection functions;

- Precisely collect and display all parameters of engine:

Temp. (WT)	°C/°F
Oil pressure (OP)	kPa/psi/bar
Fuel Level (FL)	% residual fuel level L
Engine Speed (RP)	r/min
Battery Voltage (VB)	V
Charger Voltage (VD)	V
Hours Counter (HC)	

Start times

- Control and protection function: automatic start/stop of the genset, ATS (Auto Transfer Switch) control and perfect fault indication and protection function;
- ETS (Energize To Stop), idle control, pre-heat control, speed raise control and speed drop control functions, and all output ports are relay outputs;
- Parameter setting function: allows users to modify and set the parameters and meanwhile will be stored in internal FLASH and won't be lost even in case of power outage; all controller parameters can be adjusted on front panel of the controller or via USB interface on PC.
- Multiplex input port 3 and 4 can be used in various occasions: input 3 can be used as auxiliary input port or fuel level sensor, while input 4 can be used as auxiliary input port or configurable sensor.
- Multiple temperature, oil pressure, and fuel level sensors can be used directly, and parameters can be users-defined.
- One configurable sensor: can be set to temperature sensor, oil pressure sensor or fuel level sensor, which enables the detection of double temperatures, double oil-pressures and double fuel levels.
- Multiple crank disconnect conditions (magnetic pickup, oil pressure, generator) are optional;
- Emergency start function;
- Fly teeth auto-recognition function;
- Wide power supply range: DC(8~35)V, which suitable for different starter battery voltage environments.
- All parameters apply digital adjustment, instead of conventional analog modulation with normal potentiometer, improving the wholesome reliability and stability;
- Maintenance function: types can be set to date or running time. Actions (warning, alarm shutdown) can also be set when maintenance time is out;
- Event log function (max. 99 pieces of records), real-time clock, and schedule to start/stop generator function (start once monthly/weekly/daily on/off load can be set).
- IP55 waterproofness with rubber-ring gasket between enclosure and screen;
- Metal fixing clips are used to fix the controller;
- Modular design, self-extinguished ABS plastic enclosure, pluggable connection terminals and embedded installation way; compact structure with easy mounting.

3 SPECIFICATION









Table 2 Technical Parameters

Items	Contents
Working Voltage	DC8. 0V to 35. 0V, Continuous Power Supply.
Overall Consumption	<3W(Standby mode: ≤2W)
AC voltage Input: 3 Phase 4 Wire 3 Phase 3 Wire Single phase 2 Wire 2 Phase 3 Wire	AC15V - AC360V (ph-N) AC30V - AC620V (ph-ph) AC15V - AC360V (ph-N) AC15V - AC360V (ph-N)
Alternator Frequency	50Hz/60 Hz
Speed Sensor Voltage	1.0V to 24V (RMS)
Speed Sensor Frequency	10,000 Hz (max)
Start Relay Output	5A DC28V power supply
Auxiliary Relay Output 1	5A DC28V power supply
Auxiliary Relay Output 2	5A DC28V power supply
Auxiliary Relay Output 3	5A DC28V power supply
Auxiliary Relay Output 4	5A AC28V voltage-free output
Auxiliary Relay Output 5	5A AC28V voltage-free output
Overall Dimensions	126mm x 109mm x 44mm
Panel Cutout	110mm x 90mm
CT Secondary Current	5A (rated)
Working Condition	Temperature: (-25~+70)°C; Humidity: (20~93)%RH
Storage Condition	Temperature: (-25~+70)°C
Protection Level	IP55 Gasket
Insulation Intensity	Apply AC2.2kV voltage between high voltage terminal and low voltage terminal; The leakage current is not more than 3mA within 1min.
Weight	0.26kg

4 OPERATION

4.1 PUSHBUTTONS

Table 3 Button Description

Icon	Key	Description
	Stop/ Reset	Stop the running generator in Auto/Manual mode; Reset alarms under genset alarm conditions; In stop mode, keep holding down the button for over 3 seconds and panel indicators can be tested (lamp test); In stop process, press it again and generator stops immediately.
	Start	Start genset in Manual mode. Press it again in starting process, genset status will skip to next one and it can start genset quicker.
	Manual	Pressing this key will set the module into manual mode.
	Auto	Pressing this key will set the module into auto mode.
	Close/Open	Close/Open transfer button; press and it can make controller display between close/open page and home page; In close/open page and in manual mode, press Up/Increase, Down/Decrease and breaker close/open can be controlled.
	Set/Confirm	Press and it will enter main menu page; In parameter setting status, press this key and it can shift cursor or confirm the set values.
	Up/Increase	Scrolls the screen up; shift the cursor up or increase the set value in parameter setting menu; In close/open page and in manual mode: It can control mains close/open (HGM420N); It can control gen close (HGM410N);
	Down/Decrease	Scrolls the screen down; shift the cursor down or decrease the set value in parameter setting menu. In close/open page and in manual mode: It can control gen close/open (HGM420N); It can control gen open (HGM410N);

4.2 INDICATOR LIGHT



Fig. 1 HGM410N Front Panel



Fig. 2 HGM420N Front Panel

NOTE: Partial indicator illustration:

Alarm Lamp: slowly flash for warning alarms; fast flash for shutdown alarms; light off for none alarms.

Status Lamp: light off for genset stand by; flash 1 time in start or stop process and always light on for normal running.

4.3 AUTOMATIC START/STOP OPERATION

Press  and the indicator beside is illuminated, which means genset is in auto start mode.









Auto Start Sequence:

- 1) **HGM420N:** when mains is abnormal (over/under voltage, loss of phase), genset enters into “Mains Abnormal Delay” and LCD displays countdown time. “Start Delay” timer is initiated after the delay has expired.
- 2) **HGM410N:** When “Remote Start” is active, “Start Delay” timer is initiated;
- 3) “Start Delay” countdown will be displayed on LCD;
- 4) When start delay is over, preheat relay is energized (if configured), “preheat delay XXs” information will be displayed on LCD;
- 5) After the above delay, the Fuel Relay is energized, and then one second later, the Start Relay is engaged. The engine is cranked for a pre-set time. If the engine fails to fire during this cranking attempt then the fuel relay and start relay are disengaged for the pre-set rest period; “crank rest time” begins and genset will wait for the next crank attempt.
- 6) This start sequence should continue beyond the set number of attempts, the start sequence will be terminated, the fifth line of LCD display will be highlighted with black and Fail to Start fault will be displayed.
- 7) In case of successful crank attempt, the “Safety On” timer is activated, allowing Low Oil Pressure, High Temperature, Under speed, Charge Alternator Failure and Auxiliary inputs (configured) to stabilize without triggering the fault. As soon as this delay is over, “start idle” delay is initiated (if configured).
- 8) During “start idle” delay, under speed, under frequency, under voltage alarms are inhibited. When this delay is over, “warming up” delay is initiated (if configured).
- 9) After the “warming up” delay, if generator status is normal, its indicator will be illuminated. If generator voltage and frequency have reached on-load requirements, then the generator close relay will be energized; genset will take load; generator power indicator will illuminate and generator will enter into Normal Running status. If voltage or frequency is abnormal, the controller will initiate shutdown alarm (alarm information will be displayed on LCD).



Auto Stop Sequence,

- 1) **HGM420N:** During normal running process, if mains becomes normal, controller enters into “Mains Normal Delay”. When mains indicator illuminates, “Stop Delay” is initiated.
- 2) **HGM410N:** When the “Remote Start” signal is removed, the Stop Delay is initiated.
- 3) Once this “stop delay” has expired, the Generator Breaker will open and the “Cooling Delay” is then initiated. After “Transfer Delay”, the mains close relay will be energized; mains will take load; generator power indicator will extinguish while mains power indicator will illuminate.
- 4) During “Stop Idle” Delay (if configured), idle relay is energized.
- 5) “ETS Solenoid Hold” begins, ETS relay is energized while fuel relay is de-energized.
- 6) “Fail to Stop Delay” begins, complete stop is detected automatically.
- 7) Generator is placed into its standby mode after its complete stop. Otherwise, fail to stop alarm is initiated and the corresponding alarm information is displayed on LCD.

4.4 MANUAL START/STOP OPERATION

- 1) **HGM420N:** Manual mode is selected by pressing the  button; a LED besides the button will illuminate to confirm the operation. In this mode, press  button to start the genset, it can automatically judge crank success and accelerate to high speed running. If high temperature, low oil pressure, over speed and abnormal voltage occur during genset running, controller can effectively protect genset to stop (for detail procedures please refer to No.4~9 of auto start sequence). In **Manual Mode**, load switch won't auto-switch. It needs to press  to enter close/open interface, and it controls mains switch to close/open by pressing  and controls gen switch to close/open by pressing .
- 2) **HGM410N:** Manual mode is selected by pressing the  button; the LED besides the button will illuminate to confirm the operation and the genset start. It can automatically judge crank success and accelerate to high speed running. If high temperature, low oil pressure, over speed and abnormal voltage occur during genset running, controller can effectively protect genset to stop (for detail procedures please refer to No.4~9 of auto start sequence). After genset high speed normal running, It needs to press  to enter close/open interface, and it controls mains switch to close by pressing  and controls gen switch to open by pressing  (gen is on load).
- 3) Manual stop: pressing  key can stop the running genset. (For detail procedures please refer to No.3~7 of auto stop sequence.)

4.5 EMERGENCY START

In manual mode, pressing  and  simultaneously can compel genset to start. The controller won't judge whether the controller has started successfully according to disconnect conditions and the disconnection of starter needs to control by operators. When operators observed the genset has started successfully, loose the keys and the controller enters safety delay, and start is stopped to output.

5 PROTECTION

5.1 WARNINGS

When controller detects warning alarms, it only gives warnings not shutdown. The alarm information will be displayed on LCD.

Table 4 Warning Alarms

No.	Items	Description
1	High Temp.	When the controller detects that engine temperature has exceeded the pre-set value while shutdown is prohibited, or detects that the Aux. input high temperature while shutdown is prohibited, it will initiate a warning alarm and the corresponding alarm information will be displayed on LCD.
2	Low OP	When the controller detects that the oil pressure has fallen below the pre-set value while shutdown is prohibited, or detects that the Aux. input low oil pressure while shutdown is prohibited, it will initiate a warning alarm and the corresponding alarm information will be displayed on LCD.
3	Gen Over Current	When the controller detects that the genset current has exceeded the pre-set value and the over current delay has expired, it will initiate a warning alarm and the corresponding alarm information will be displayed on LCD.
4	Fail To Stop	After "fail to stop" delay/ ETS delay has expired, if gen-set does not stop completely, it will initiate a warning alarm and the corresponding alarm information will be displayed on LCD.
5	Low Fuel Level	When the controller detects that the fuel level has fallen below the pre-set value while shutdown is prohibited, or detects that the Aux. input low fuel level while shutdown is prohibited, it will initiate a warning alarm and the corresponding alarm information will be displayed on LCD.
6	Charge Alt Failure	When the controller detects that charger voltage has fallen below the pre-set value, it will initiate a warning alarm and the corresponding alarm information will be displayed on LCD.
7	Battery Under Volt	When the controller detects that battery voltage has fallen below the pre-set value, it will initiate a warning alarm and the corresponding alarm information will be displayed on LCD.
8	Battery Over Volt	When the controller detects that battery voltage has exceeded the pre-set value, it will initiate a warning alarm and the corresponding alarm information will be displayed on LCD.
9	Aux. Input	When the controller detects that the auxiliary input warning signals, it will initiate a warning alarm and the corresponding alarm information will be displayed on LCD.
10	Loss Of Speed Signal	When the controller detects that the engine speed is 0 and the delay is 0, it will initiate a warning alarm and the corresponding alarm information will be displayed on LCD.



No.	Items	Description
11	Low Coolant Level	When the controller detects the low coolant level input is active, it will initiate a warning alarm and the corresponding alarm information will be displayed on LCD.
12	Temp. Sensor Open	When the controller detects that the temperature sensor is open circuit and the action select "Warn", it will initiate a warning alarm and the corresponding alarm information will be displayed on LCD.
13	OP Sensor Open	When the controller detects that the oil pressure sensor is open circuit and the action select "Warn", it will initiate a warning alarm and the corresponding alarm information will be displayed on LCD.
14	Level Sensor Open	When the controller detects that the level sensor is open circuit and the action select "Warn", it will initiate a warning alarm and the corresponding alarm information will be displayed on LCD.
15	Temp. Sensor 2 Open	If the config. sensor set as temperature sensor, When the controller detects that the temperature sensor is open circuit and the action select "Warn", it will initiate a warning alarm and the corresponding alarm information will be displayed on LCD.
16	OP Sensor 2 Open	If the config. sensor set as oil pressure sensor, When the controller detects that the oil pressure sensor is open circuit and the action select "Warn", it will initiate a warning alarm and the corresponding alarm information will be displayed on LCD.
17	Level Sensor Open	If the config. sensor set as level sensor, When the controller detects that the level sensor is open circuit and the action select "Warn", it will initiate a warning alarm and the corresponding alarm information will be displayed on LCD.
18	High Temp. 2	When the controller detects that config. sensor temperature (sensor type: temperature sensor) has exceeded the pre-set value while shutdown is prohibited, it will initiate a warning alarm and the corresponding alarm information will be displayed on LCD.
19	Low OP 2	When the controller detects that config. sensor oil pressure (sensor type: oil pressure sensor) has fallen below the pre-set value while shutdown is prohibited, it will initiate a warning alarm and the corresponding alarm information will be displayed on LCD.
20	Low Level	When the controller detects that config. sensor low level (sensor type: level sensor) has fallen below the pre-set value while shutdown is prohibited, it will initiate a warning alarm and the corresponding alarm information will be displayed on LCD.
21	Maintenance Due	When genset running time has exceeded the user setting maintenance time and the action select "Warn", it will initiate a warning alarm and the corresponding alarm information will be displayed on LCD. The maintenance alarm will reset if the action select "Inactive".
22	Gen Over Volt	When the controller detects that the generator voltage has exceeded the pre-set value, it will initiate a warning alarm and the corresponding alarm information will be displayed on LCD.



No.	Items	Description
23	Gen Under Volt	When the controller detects that the genset voltage has fallen below the pre-set value, it will initiate a warning alarm and the corresponding alarm information will be displayed on LCD.
24	Gen Over Freq	When the controller detects that the genset frequency has exceeded the pre-set value, it will initiate a warning alarm and the corresponding alarm information will be displayed on LCD.
25	Gen Under Freq	When the controller detects that the genset frequency has fallen below the pre-set value, it will initiate a warning alarm and the corresponding alarm information will be displayed on LCD.
26	Fail to Charge	When the controller detects that the fail to charge warning signals, it will initiate a warning alarm and the corresponding alarm information will be displayed on LCD.
27	Over Power	If over power detection is enabled, when the controller detects that the over power value (power is positive) has exceeded the pre-set value and the action select "Warn", it will initiate a warning alarm.

5.2 SHUTDOWN ALARM

When controller detects shutdown alarm, it will send signal to open breaker and shuts down generator. The alarm information will be displayed on LCD.

Table 5 Shutdown Alarms

No	Items	Description
1	Emergency Shutdown	When the controller detects that the emergency shutdown signal, it will initiate a shutdown alarm and the corresponding alarm information will be displayed on LCD.
2	Over Speed	When the controller detects that the generator speed has exceeded the pre-set value, it will initiate a shutdown alarm and the corresponding alarm information will be displayed on LCD.
3	Under Speed	When the controller detects that the generator speed has fallen below the pre-set value, it will initiate a shutdown alarm and the corresponding alarm information will be displayed on LCD.
4	Loss Of Speed Signal	When the controller detects that the engine speed is 0 and the delay is <i>NOT</i> 0, it will initiate a shutdown alarm and the corresponding alarm information will be displayed on LCD.
5	Gen Over Freq	When the controller detects that the genset frequency has exceeded the pre-set value, it will initiate a shutdown alarm and the corresponding alarm information will be displayed on LCD.
6	Gen Under Freq	When the controller detects that the genset frequency has fallen below the pre-set value, it will initiate a shutdown alarm and the corresponding alarm information will be displayed on LCD.
7	Gen Over Voltage	When the controller detects that the genset voltage has exceeded the pre-set value, it will initiate a shutdown alarm and the corresponding alarm



No	Items	Description
		information will be displayed on LCD.
8	Gen Under Voltage	When the controller detects that the genset voltage has fallen below the pre-set value, it will initiate a shutdown alarm and the corresponding alarm information will be displayed on LCD.
9	Gen Over Current	When the controller detects that the genset current has exceeded the pre-set value and delay is not 0, it will initiate a shutdown alarm and the corresponding alarm information will be displayed on LCD.
10	Fail To Start	If the engine does not fire after the pre-set number of attempts, it will initiate a shutdown alarm and the corresponding alarm information will be displayed on LCD.
11	High Temp.	When controller detects that the water/cylinder temperature has exceeded the pre-set value, it will initiate a shutdown alarm and the corresponding alarm information will be displayed on LCD.
12	Low OP	When the controller detects that the oil pressure has fallen below the pre-set value, it will initiate a shutdown alarm and the corresponding alarm information will be displayed on LCD.
13	No Gens Freq	When the controller detects that the genset frequency is 0, it will initiate a shutdown alarm and the corresponding alarm information will be displayed on LCD.
14	Low Fuel Level	When the controller detects that the fuel level has fallen below the pre-set value or detects that the low fuel level input is active, it will initiate a shutdown alarm and the corresponding alarm information will be displayed on LCD.
15	Low Coolant Level	When the controller detects the low coolant level input is active, it will initiate a shutdown alarm and the corresponding alarm information will be displayed on LCD.
16	Temp. Sensor Open	When the controller detects that the temperature sensor is open circuit and the action select "Shutdown", it will initiate a shutdown alarm and the corresponding alarm information will be displayed on LCD.
17	OP Sensor Open	When the controller detects that the oil pressure sensor is open circuit and the action select "Shutdown", it will initiate a shutdown alarm and the corresponding alarm information will be displayed on LCD.
18	Fuel Level Sensor Open	When the controller detects that the level sensor is open circuit and the action select "Shutdown", it will initiate a shutdown alarm and the corresponding alarm information will be displayed on LCD.
19	Temp. Sensor 2 Open	If the config. sensor set as temperature sensor, When the controller detects that the temperature sensor is open circuit and the action select "Shutdown", it will initiate a shutdown alarm and the corresponding alarm information will be displayed on LCD.
20	OP Sensor 2 Open	If the config. sensor set as oil pressure sensor, When the controller detects that the oil pressure sensor is open circuit and the action select "Shutdown", it will initiate a shutdown alarm and the corresponding alarm information will be displayed on LCD.



No	Items	Description
21	Level Open Sensor	If the config. sensor set as level sensor, When the controller detects that the level sensor is open circuit and the action select "Shutdown", it will initiate a shutdown alarm and the corresponding alarm information will be displayed on LCD.
22	High Temp. 2	When the controller detects that config. sensor temperature (sensor type: temperature sensor) has exceeded the pre-set value, it will initiate a shutdown alarm and the corresponding alarm information will be displayed on LCD.
23	Low OP 2	When the controller detects that config. sensor oil pressure (sensor type: oil pressure sensor) has fallen below the pre-set value, it will initiate a shutdown alarm and the corresponding alarm information will be displayed on LCD.
24	Low Level	When the controller detects that config. sensor fuel level (sensor type: level sensor) has fallen below the pre-set value, it will initiate a shutdown alarm and the corresponding alarm information will be displayed on LCD.
25	Maintenance Due	When genset running time has exceeded the user setting maintenance time and the action select "Shutdown", it will initiate a shutdown alarm and the corresponding alarm information will be displayed on LCD. The maintenance alarm will reset if the action select "Inactive".
26	Over Power	If over power detection is enabled, when the controller detects that the over power value (power is positive) has exceeded the pre-set value and the action select "Shutdown", it will initiate a shutdown alarm and the corresponding alarm information will be displayed on LCD.

6 CONNECTIONS

Compared with **HGM420N**, **HGM410N** has not Mains Voltage 3-phase input terminals. The rear panel of **HGM420N** is as below.

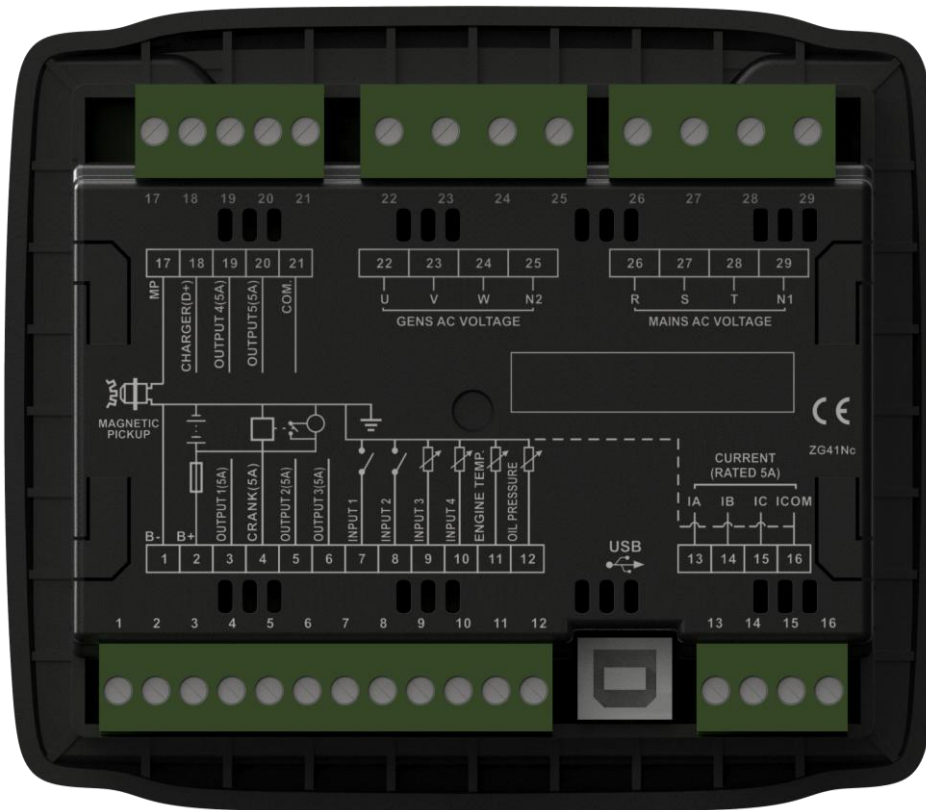

Fig. 3 Back Panel

Table 6 Terminal Connection Description

Pin	Function	Cable Size	Description
1	B-	2.5mm ²	Connected with negative of starter battery.
2	B+	2.5mm ²	Connected with positive of starter battery. If wire length is over 30m, better to double wires in parallel. Max. 20A fuse is recommended.
3	Aux. Output 1	1.5mm ²	B+ is supplied by 2 point, rated 5A.
4	Crank	1.5mm ²	B+ is supplied by 2 point, rated 5A. Connect to starter coil.
5	Aux. Output 2	1.5mm ²	B+ is supplied by 2 point, rated 5A.
6	Aux. Output 3	1.5mm ²	B+ is supplied by 2 point, rated 5A.
7	Digital Input 1	1.0mm ²	Ground connected is active (B-)
8	Digital Input 2	1.0mm ²	Ground connected is active (B-)
9	Digital Input 3	1.0mm ²	Ground connected is active (B-); Can be used as Level Sensor.

For details please see Table 2.

For set items please see Table 9.



Pin	Function	Cable Size	Description
10	Digital Input 4	1.0mm ²	Ground connected is active (B-); Can be used as Config. Sensor.
11	Engine Temp. Sensor	1.0mm ²	Connect to temperature/cylinder resistance sensor.
12	Oil Press Sensor	1.0mm ²	Connect to oil pressure resistance sensor.
13	Current IA	1.5mm ²	Outside connected to secondary coil of current transformer(rated 5A)
14	Current IB	1.5mm ²	Outside connected to secondary coil of current transformer(rated 5A)
15	Current IC	1.5mm ²	Outside connected to secondary coil of current transformer(rated 5A)
16	Current COM	1.5mm ²	See INSTALLATION in this manual.
17	Magnetic Pickup	0.5mm ²	Connect to speed sensor; Shielded wire is recommended. The other end of speed sensor connects to B-.
18	Charger D+	1.0mm ²	Connect to charging starter's D+ terminal. If there is not this terminal, then hang it up.
19	Aux. Output 4	1.0mm ²	The combination of terminal 19 and 21 is relay normally open contact; rated 5A; Voltage free.
20	Aux. Output 5	1.0mm ²	The combination of terminal 20 and 21 is relay normally open contact; rated 5A; Voltage free.
21	Aux. Output COM	1.5mm ²	Common terminal of auxiliary output 4 and 5.
22	Gen AC Voltage U	1.0mm ²	Connected to U-phase of generator (2A fuse is recommended)
23	Gen AC Voltage V	1.0mm ²	Connected to V-phase of generator (2A fuse is recommended)
24	Gen AC Voltage W	1.0mm ²	Connected to W-phase of generator (2A fuse is recommended)
25	Gen AC Voltage N2	1.0mm ²	Connected to N-wire of generator.
26	Mains AC Voltage R	1.0mm ²	Connected to R-phase of mains (2A fuse is recommended) (HGM410N without)
27	Mains AC Voltage S	1.0mm ²	Connected to S-phase of mains (2A fuse is recommended) (HGM410N without)
28	Mains AC Voltage T	1.0mm ²	Connected to T-phase of mains (2A fuse is recommended) (HGM410N without)
29	Mains AC Voltage N1	1.0mm ²	Connected to N-wire of mains (HGM410N without)

NOTE: USB interface is parameter programmable interface, which can be programmed on PC.

7 DEFINITION AND RANGE OF PARAMETERS

7.1 PARAMETER CONTENTS AND RANGE

Table 7 Parameter Contents and Range

No	Items	Range	Default	Description
1	Mains Normal Delay	(0-3600)s	10	The time from mains abnormal to normal or from normal to abnormal; suitable for ATS (automatic transfer switch).
2	Mains Abnormal Delay	(0-3600)s	5	
3	Mains Under Volt	(30-620)V	184	When mains voltage has fallen below the set value, Mains Under Voltage is active. When set the value as 30V, the controller does not detect under voltage signal. Back lash: 10V
4	Mains Over Volt	(30-620)V	276	When mains voltage has exceeded the set value, Mains Over Voltage is active. When set the value as 620V, the controller does not detect over voltage signal. Back lash: 10V
5	Transfer Rest Delay	(0-99.9)s	1.0	Interval time from mains switch off to generator switch on; or from generator switch off to mains switch on.
6	Start Delay	(0-3600)s	1	Time from mains abnormal or remote start signal is active to start genset.
7	Stop Delay	(0-3600)s	1	Time from mains normal or remote start signal is deactivated to genset stop.
8	Start Attempts	(1-10)times	3	Maximum crank times of crank attempts. When reach this number, controller will send start failure signal.
9	Preheat Time	(0-300)s	0	Power-on time of heater plug before starter is powered up.
10	Cranking Time	(3-60)s	8	Power-on time of starter
11	Crank Rest Time	(3-60)s	10	The waiting time before second power up when engine start fail.
12	Safety On Delay	(1-60)s	10	Alarms for low oil pressure, high temperature, under speed, under frequency/voltage, charge alt failure are inactive.
13	Start Idle Time	(0-3600)s	0	Idle running time of genset when starting.
14	Warming Up Time	(0-3600)s	10	Warming time between genset switch on and high speed running.
15	Cooling Time	(3-3600)s	10	Radiating time before genset stop, after it unloads.
16	Stop Idle	(0-3600)s	0	Idle running time when genset stop.
17	ETS Solenoid Hold	(0-120)s	20	Stop electromagnet's power on time when genset is stopping.



No	Items	Range	Default	Description
18	Fail to Stop Delay	(0-120)s	0	Time between ending of genset idle delay and stopped when “ETS time” is set as 0; Time between ending of ETS hold delay and stopped when “ETS time” is not 0.
19	Breaker Close Time	(0-10)s	5.0	Pulse width of mains/generator switch on. When it is 0, means output constantly.
20	Flywheel Teeth	(10.0-300.0)	118.0	Tooth number of the engine, for judging of starter crank disconnect conditions and inspecting of engine speed. See the installation instructions.
21	Gen Abnormal Delay	(0-20.0)s	10.0	The alarm delay of generator over voltage and under voltage.
22	Gen Over Volt	(30-620)V	276	When generator voltage has exceeded the set value and the “Gen abnormal delay” has expired, Gen Over Voltage is active. When set the value as 620V, the controller does not detect over voltage signal.
23	Gen Under Volt	(30-620)V	184	When generator voltage has fallen below the set value and the “Gen abnormal delay” has expired, Gen Under Voltage is active. When set the value as 30V, the controller does not detect under voltage signal.
24	Under Speed	(0-6000)r/min	1200	When engine speed has fallen below the set value for 10s, Under Speed is active. It will initiate a shutdown alarm signal.
25	Over Speed	(0-6000)r/min	1710	When engine speed has exceeded the set value for 2s, Over Speed is active. It will initiate a shutdown alarm signal.
26	Under Freq	(0-75.0)Hz	40.0	When generator frequency has fallen below the set value but Not equal to 0 for 10s, Under Frequency is active. It will initiate a shutdown alarm signal.
27	Over Freq	(0-75.0)Hz	57.0	When generator frequency has exceeded the set value for 2s, Over Frequency is active. It will initiate a shutdown alarm signal.
28	High Temp.	(80-140)°C	98	When the temperature value of the external temperature sensor exceeds the set value, “High Temperature” timer is initiated. Detecting only after safety on delay has expired. If the set value is 140, high temperature signal will not be sent (this only concerns external temperature sensor, not high temperature signal via config. input port).



No	Items	Range	Default	Description
29	Low OP	(0-400)kPa	103	When the external pressure sensor value falls below this set value, "Low Oil Pressure" timer is initiated. Detecting only after safety on delay has expired. If the set value is 0, low oil pressure signal will not be sent (this only concerns pressure sensor and does not concern low oil pressure warning signal via configurable input port)
30	Low Fuel Level	(0-100)%	10	When the liquid level of the external sensor falls below the set value, "Low Fuel Level" timer is initiated. (this only concerns fuel level sensor and does not concern low fuel level warning signal via configurable input port)
31	Aux. Sensor	(80-140)°C (0-400)kPa (0-100)%	98	Each value correspond to above 28 (Temperature sensor), 29 (Oil pressure sensor) and 30 (Level sensor), respectively.
32	Loss of Speed Signal	(0-20.0)s	5.0	If the set value is 0, only warning and not to shutdown the generator.
33	Charge Alt Failure	(0-30)V	6.0	During generator is normal running, when alternator D+(WL) voltage has fallen below the set value and remains for 5s, It will initiate a shutdown alarm signal.
34	Battery Over Volt	(12-40)V	33.0	When battery voltage has exceeds the set value and remains for 20s, It will initiate a warning alarm signal. Only warning and not to shutdown the generator.
35	Battery Under Volt	(4-30)V	8.0	When battery voltage has fallen below the set value and remains for 20s, It will initiate a warning alarm signal. Only warning and not to shutdown the generator.
36	Current Trans.	(5-6000)/5	500	The ratio of external CT
37	Full Load Current Rating	(5-6000)A	500	Generator's rated current, used for load over current calculating.
38	Over Current Percentage	(50-130)%	120	When the load current has exceeded the set value, "over current" delay is initiated.
39	Over Current Delay	(0-3600)s	30	When load current has exceeded the set value and the "over current" delay has expired, over current alarm is initiated. When the set value is 0, only warning and not to shutdown the generator.
40	Fuel Pump On	(0-100)%	25	When fuel level has fallen below the set value for 10s, "Fuel Pump On" alarm is initiated.



No	Items	Range	Default	Description
41	Fuel Pump Off	(0-100)%	80	When fuel level has exceeded the set value for 10s, "Fuel Pump Off" alarm is initiated.
42	Aux. Output 1	(0-17)	14	Factory default: Fuel Relay Output
43	Aux. Output 2	(0-17)	2	Factory default: Energized To Stop
44	Aux. Output 3	(0-17)	3	Factory default: Idle Control
45	Aux. Output 4	(0-17)	5	Factory default: Close Generator
46	Aux. Output 5	(0-17)	6	Factory default: Mains Closed
47	Digital Input 1	(0-15)	1	Factory default: High Temperature Input
48	Digital Input 1 Active	(0-1)	0	Factory default: Close to active
49	Digital Input 1 Delay	(0-20.0)s	2.0	
50	Digital Input 2	(0-15)	2	Factory default: Low Oil Pressure Warning Input
51	Digital Input 2 Active	(0-1)	0	Factory default: Close to active
52	Digital Input 2 Delay	(0-20.0)s	2.0	
53	Digital Input 3	(0-15)	10	Factory default: Remote Start
54	Digital Input 3 Active	(0-1)	0	Factory default: Close to active
55	Digital Input 3 Delay	(0-20.0)s	2.0	
56	Digital Input 4	(0-15)	11	Factory default: Fuel Level Warn
57	Digital Input 4 Active	(0-1)	0	Factory default: Close to active
58	Digital Input 4 Delay	(0-20.0)s	2.0	
59	Power On Mode	(0-2)	0	0: Stop Mode 1: Manual Mode 2: Auto Mode
60	Module Address	(1-254)	1	Communication address of controller.
61	Passwords	(0-9999)	0318	Please see NOTE 6 for details.
62	Crank Disconnect	(0-6)	2	There are 3 conditions of disconnecting starter with engine: Generator Frequency, Magnetic Pickup, Oil Pressure. Each condition can be used alone and simultaneously to separating the start motor and genset as soon as possible.
63	Disconnect Magnetic Pickup	(0-3000)r/min	360	When engine speed higher than the set value, starter will be disconnected.
64	Disconnect Gen Freq	(10.0-30.0)Hz	14.0	When generator frequency higher than the set value, starter will be disconnected.
65	Disconnect OP	(0-400)kPa	200	When generator oil pressure higher than the set value, starter will be disconnected.
66	High Temp. Inhibit Enabled	(0-1)	0	Factory default: when high temperature occurs, shutdown alarm is initiated. NOTE 2
67	Low OP Inhibit Enabled	(0-1)	0	Factory default: when low oil pressure occurs, shutdown alarm is initiated. NOTE 3
68	Low Fuel Level Inhibit	(0-1)	1	Factory default: when low fuel level occurs, shutdown alarm is initiated. NOTE 4



No	Items	Range	Default	Description
69	Config. Sensor Inhibit	(0-1)	1	Factory default: when config. sensor value higher/lower than the set value (particular case depends on the sensor type), shutdown alarm is initiated.
70	AC System	(0-3)	0	0: 3P4W; 1: 2P3W 2: 1P2W; 3: 3P3W
71	Temp. Sensor Curve	(0-12)	8	SGX Please see Table 10.
72	Pressure Sensor Curve	(0-12)	8	SGX Please see Table 10.
73	Multiplex Input 1	(0-1)	0	0: Digital Input 3 1: Level Sensor Please see Table 8. NOTE 5
74	Level Sensor Curve	(0-7)	3	SGD Please see Table 10.
75	Multiplex Input 2	(0-3)	0	0: Digital Input 4 1: Temperature Sensor 2: Oil Pressure Sensor 3: Level Sensor Please see Table 8. NOTE 5
76	Config. Sensor Curve	(0-9) (0-9) (0-5)	8 8 3	SGX SGX SGD
77	Poles	(2-64)	4	
78	Temp. Sensor Open	(0-2)	1	0:Indication; 1:Warn; 2:Shutdown (temperature sensor will show “+++”);
79	OP Sensor Open	(0-2)	1	0: Indication (oil pressure sensor will show “+++”); 1:Warn; 2:Shutdown
80	Fuel Level Sensor Open	(0-2)	1	0: Indication (fuel level sensor will show “+++”); 1:Warn; 2:Shutdown
81	Config. Sensor Open	(0-2)	1	0: Indication (LCD display will show “+++”); 1:Warn; 2:Shutdown
82	Cooling Blower On	(0-140)°C	60	It controls the cooling blower to open or close if the output port is configured as Cooling Blower.
83	Cooling Blower Off	(0-140)°C	40	
84	Low Fuel Level Warn	(0-100)%	20	When the liquid level of the external sensor falls below the set value, “Low Fuel Level” timer is initiated. (this only concerns fuel level sensor and does not concern low fuel level warning signal via configurable input port)
85	Gen Over Volt Warn	(30-620)V	253	When genset voltage is over the point, generator over voltage is active. When the point is 620V, generator over voltage is disabled.
86	Gen Under Volt	(30-620)V	193	When generator voltage is under the point, generator under voltage is active. When the



No	Items	Range	Default	Description
				point is 30V, generator under voltage is disabled.
87	Gen Over Freq Warn	(0-75.0)Hz	55.0	When generator's frequency is over the point, generator over frequency is active.
88	Gen Under Freq Warn	(0-75.0)Hz	42.0	When generator frequency is lower than the point, warn alarm signal will be sent.
89	Gen Over Current Warn Percentage	(50-130)%	110	When load current is over the point, over current is active. When this value is 0, warn alarm signal won't be sent.
90	High Temp. Warn	(80-140)°C	95	When the temperature value of the external temperature sensor exceeds the set value, "High Temperature" timer is initiated. Detecting only after safety on delay has expired. If the set value is 140, high temperature signal will not be sent (this only concerns external temperature sensor, not high temperature signal via config. input port).
91	Low OP Warn	(0-400)kPa	124	When the external pressure sensor value falls below this set value, "Low Oil Pressure" timer is initiated. Detecting only after safety on delay has expired. If the set value is 0, low oil pressure signal will not be sent (this only concerns pressure sensor and does not concern low oil pressure warning signal via configurable input port)
92	Aux. Sensor Warn	(80-140)°C (0-400)kPa (0-100)%	95	Respective corresponding with 90 temp. sensor, 91 pressure sensor and 84 level sensor in this table.
93	Gen Over Volt Delay	(0-20.0)s	10.0	When generate voltage exceeds shutdown value and last for a while, gen over volt shutdown is active.
94	Gen Over Freq Delay	(0-20.0)s	2.0	When generate frequency exceeds shutdown value and last for a while, gen over freq shutdown is active.
95	Disconnect OP Delay	(0-20.0)s	0.0s	When disconnect conditions include oil pressure and engine oil pressure is higher than disconnect oil pressure delay, the genset is regarded as start successfully and starter will disconnect.
96	Timing Start	(0-1) (0-1)	0 0	0: Disabled; 1:Enabled 0:No-load; 1:On-load
97	Timing Start Circulate	(0-2) (1-31)	0 1	0: monthly; 1: weekly; 2:daily Day(0:monthly is active)



No	Items	Range	Default	Description
		(0-7)	0	Week(0:weekly is active)
		(1-23)h	0	Prohibit start time (h)
		(1-59)min	0	Prohibit start time (min)
		(0-30000)min	30	Duration
98	Auto Start Inhibited	(0-1)	0	0: Disabled; 1:Enabled
99	Auto Start Circulate Inhibited	(0-2)	0	0: monthly; 1: weekly; 2:daily
		(1-31)	1	Day(0:monthly is active)
		(0-7)	0	Week(0:weekly is active)
		(1-23)h	0	Prohibit start time (h)
		(1-59)min	0	Prohibit start time (min)
		(0-30000)min	30	Duration
100	Over Power	(0-2)	0	0 Inactive; 1 Warn; 2 Alarm Shutdown
		(0-6000)kW	304	Over power setting value
		(0-6000)kW	290	Over power warn return
		(0-3600)s	5	Over power delay When power is higher than preset value and duration exceeds than delay, over power warning is active. Return and delay value can be set.
101	Date	Set the date of controller.		
102	Custom Sensor Curve	(0-3)	0	0 Custom temperature sensor 1 Custom pressure sensor 2 Custom level sensor 3 Custom auxiliary sensor Choose sensor which need to be set, input every point(8 points need to be input) resistance and corresponding value(or current, voltage) of curve.

NOTE 1: The No. column is for HGM420N, and for HGM410N please deduct 5 for parameter No. on the basis of HGM420N No. as HGM410N doesn't have the first 5 parameters.

NOTE 2: if "high temperature inhibit" is configured, or set auxiliary input as "inhibit high temperature stop" and this input is active, when temperature is higher than the preset value, or high temperature alarm input is active, controller will send warning signal only and not stop the unit.

NOTE 3: if "low oil pressure inhibit" is configured, or set auxiliary input as "inhibit low oil pressure stop" and this input is active, when oil pressure is lower than the preset value, or low oil pressure alarm input is active, controller will send warning signal only and not stop the unit.

NOTE 4: if "low fuel level inhibit" is configured, or set auxiliary input as "inhibit low fuel level stop" and this input is active, when fuel level is lower than the preset value, or low fuel level alarm input is active, controller will send warning signal only and not stop the unit.

NOTE 5: Multiplex Input can be set as "auxiliary input" or "sensor"; if one of them is set successfully, then the corresponding items are active. For instance, if set "Multiplex Input 3" as "Auxiliary Input", the related configuration items of auxiliary input 3 are active; if set "Multiplex Input 3" as "Level Sensor", the related configuration items of level sensor are active;

NOTE 6: If default password (0318) isn't changed, it doesn't need to input for configuring parameters via PC software; if the password is changed for the first time via PC software, it need to input password in password window.

NOTE 7: Between input correct password and LCD back light haven't got dark, input parameter numbers can enter parameter setting interface when input "Password Input" again.

NOTE 8: In teeth configuration interface, when power is larger than 20Hz, press start key for auto calculating teeth numbers and press confirm key for changing teeth numbers.





SmartGen

7.2 PROGRAMMABLE OUTPUT 1-5

Table 8 Definable Contents of Programmable Output 1-5

No	Items	Description
0	Not Used	Output port is deactivated when “Not Used” is selected.
1	Common Alarm	Include all shutdown alarms and warning alarms. When there is warning alarm only, it is not self-lock; when a shutdown alarm occurs, it is self-lock until the alarm is reset.
2	Energized to Stop	Suitable for genset with electromagnet and will active after “stop idle delay”. It is deactivated when the “ETS Solenoid delay” expires.
3	Idle Control	Used for engine which has idles. Close before starting and open in warming up delay; Close during stop idle delay and open when stop is completed.
4	Preheat Control	Close before starting and open before power up;
5	Close Generator	When close time is 0, it's continuous output.
6	Mains Closed	HGM410N without
7	Open ATS	When close time is 0, it's disabled.
8	Raise Speed	Close when the generator enters into Warming Up delay (close time: warming up delay) while open when Aux.
9	Drop Speed	Close when the generator enters into Stop Idle delay/ Energized to Stop delay (close time: Stop Idle delay) while open when Aux.
10	Gen Run	Action when genset is starting and disconnect when stop is completed.
11	Fuel Pump Control	Close when fuel level is lower than the “Fuel Pump On” value or when low fuel level warning input is active; Open when fuel level is higher than the “Fuel Pump Off” and low fuel level warning input is deactivated;
12	High Speed Control	Close when the generator enters into Warming Up delay while open after cooling delay.
13	In Auto Mode	The controller is in automatic mode.
14	Fuel Relay Output	Close when the generator enters into Warming Up delay while open after cooling delay.
15	Generator Excite	Output in start period. If there is no generator frequency during safety running, output for 2 seconds.
16	Air Cooler Output	Control air cooler to start\stop according to cooler temperature.
17	Louver Control	Action when genset starting and disconnect when genset stopped completely.
18	Shutdown Alarm	Alarm when genset shutdown.
19	Audible Alarm	When shutdown alarm and warn alarm, audible alarm is set as 300s. In audible alarm output duration, when panel any key or “alarm mute” input is active, it can remove the alarm.
20	Cooler Control	It is controlled by cooler of temperature sensor's limited threshold.
21~31	Reserved	

7.3 PROGRAMMABLE INPUT 1-4 (ACTIVE WHEN CONNECT GND (B-))
Table 9 Definable Contents of Programmable Input 1-4 (Active for GND (B-) Connected)

No	Items	Description
0	Not Used	
1	High Temp. Input	If these signals are active after safety on delay, shutdown alarm will be immediately initiated.
2	Low OP Warning Input	
3	Auxiliary Warning	Only warning and not stops if this input is active.
4	Emergency Stop Input	Shutdown alarm will be immediately initiated if this input is active.
5	High Temp. Stop Input	When the gen-set is running normally and this signal is activated, if there is a high temperature situation, the controller will first cool down the generator and then stop it; if the signal is deactivated and a high temperature situation occurs, the controller will shut down the gen-set without cooling down.
6	Generator Closed Input	Connect to auxiliary port of gen load breaker.
7	Mains Closed Input	Connect to auxiliary port of mains load breaker.
8	Inhibit High Temp. Stop	When it is active, prohibit stopping when high temperature occurs. NOTE 2
9	Inhibit Low OP Stop	When it is active, prohibit stopping when low oil pressure occurs. NOTE 3
10	Remote Start Input	In Auto mode, when input active, genset can be started and with load after genset is OK; when input inactive, genset will stop automatically.
11	Low Fuel Level Warn	Connected to sensor digital input. The controller sends an warning alarm signal when active.
12	Low Water Level Warn	
13	Low Fuel Level Shutdown	Connected to sensor digital input. The controller sends an shutdown alarm signal when active.
14	Low Water Level Shutdown	
15	Auto Start Inhibit	In Auto mode, if this input is active, whether mains is normal or not, the controller will not give a start command to the generator. If generator is normal running, stop command won't be executed. When this input is deactivated, genset will automatically start or stop according to the mains status (normal or abnormal).
16	Remote Control Input	All buttons in panel is inactive except    and Remote Mode is displayed on LCD. Remote module can switch module mode and start/stop operation via panel buttons.
17	Failed To Charge	Connect to failed to charge output.
18	Panel Lock	All buttons in panel is inactive except    and there is  in the left of fifth row in LCD when input is active.
19	Manual/Auto Switch	When input is active, enter into auto mode automatically, panel buttons and local operation are inactive; When input is inactive, enter into manual mode automatically, remote operation is inhibited.
20	Alarm Mute	Can prohibit "Audible Alarm" output when input is active.
21~31	Reversed	

7.4 SENSOR SELECT
Table 10 Sensor Selection

No	Item	Content	Description
1	Temp. Sensor	0 Not used 1 User Defined Resistive Type 2 VDO 3 SGH 4 SGD 5 CURTIS 6 DATCON 7 VOLVO-EC 8 SGX 9 Reserved 10 Reserved 11 Low Digit Input Active 12 High Digit Input Active	Defined resistive range is (0~6000) Ω , default is SGX sensor.
2	Pressure Sensor	0 Not used 1 User Defined Resistive Type 2 VDO 10bar 3 SGH 4 SGD 5 CURTIS 6 DATCON 7 VOLVO-EC 8 SGX 9 Reserved 10 Reserved 11 Low Digit Input Active 12 High Digit Input Active	Defined resistive range is (0~6000) Ω , default is SGX sensor.
3	Fuel Level Sensor	0 Not used 1 User Defined Resistive Type 2 SGH 3 SGD 4 Reserved 5 Reserved 6 Low Digit Input Active 7 High Digit Input Active	Defined resistive range is (0~6000) Ω , default is SGD sensor.

7.5 CONDITIONS OF CRANK DISCONNECT

Table 11 Crank Disconnect Conditions

No.	Content
0	Magnetic pickup
1	Generator Frequency
2	Magnetic pickup + Generator Frequency
3	Magnetic pickup + Oil pressure
4	Generator Frequency + Oil pressure
5	Generator Frequency + Magnetic pickup + Oil pressure
6	Oil pressure

- 1) There are 3 conditions to make starter separated with engine; magnetic pickup, generator frequency and oil pressure, which can be used separately, but oil pressure is suggested to be used together with magnetic pickup and generator frequency. The aim is to disconnect the starter motor as soon as possible.
- 2) Magnetic pickup is the magnetic equipment installed in starter for detecting flywheel teeth.
- 3) When magnetic pickup is selected, please ensure the number of flywheel teeth is the same as setting, otherwise, "over speed shutdown" or "under speed shutdown" may be caused.
- 4) If genset is without magnetic pickup, please don't select corresponding items, otherwise, "start fail" or "loss speed signal" may be caused.
- 5) If genset is without oil pressure sensor, please don't select corresponding items.
- 6) If generator frequency is not selected in crank disconnect settings, controller will not collect and display the relative power quantity (can be used in water pump set); if magnetic pickup is not selected in crank disconnect setting, the engine speed displayed in controller is calculated by generator signal.

8 PARAMETERS SETTING

8.1 PARAMETER SETTINGS

Start the controller, then press  to enter into the parameters setting menu as below:

1. Set Parameters
2. Information
3. Language
4. Event Log
5. Maintenance Setting

Password "0318" can allow to set all items in Table 7 during inputting password. When default password (0318) is changed, it needs to input the same password as controller for parameter setting via PC software. If more parameter items are needed to set or password is forgotten, such as voltage and current calibration, please contact with the factory.

▲NOTES:

- 1) **HGM410N** doesn't have items 1-5 in Table 7; programmable outputs 1-4 don't have digital outputs about mains.
- 2) Please modify the parameters in standby mode (crank conditions, auxiliary input and output configuration, multi delays, etc.) otherwise shutdown alarm or other abnormal conditions may appear.
- 3) The over-voltage threshold must be greater than the under-voltage threshold; otherwise over-voltage and under-voltage may occur at the same time.
- 4) The over-speed threshold must be greater than under-speed threshold, otherwise over speed and under speed may occur at the same time.
- 5) Set frequency value (after crank disconnect) as low as possible, in order to disconnect starter quickly.
- 6) Programmable inputs 1-4 cannot be set to the same items, otherwise it cannot realize correct function; programmable outputs 1-5 can be set as the same item.
- 7) Digital input 3 can be configured as Fuel Level Sensor. Digital input 4 can be configured as Temperature Sensor, Oil Pressure Sensor and Water Level Sensor. Digital input and sensor can be selected for any one: if input configuration is chosen, the corresponding digital input parameter is active and the sensor parameter is inactive but saved; on the contrary, if sensor is chosen, the corresponding sensor parameter is active and the digital input parameter is inactive but saved.
- 8) If it needs to shut down after cooling, please set any input as "stop after cooling" item, then connect this input to ground; or set high temperature stop action as "cooling stop".

8.2 CONTROLLER INFORMATION

a) On this page it will display information of controller, such as software version, hardware version, issue date.

b) **▲NOTE:** Press  and it will display the status of digital inputs and outputs.

c) LCD contract

d) Press  and  (or  and ) simultaneously and it can adjust LCD contract and and

make LCD characters clearer. Adjustment range is 0-7.

8.3 LANGUAGE

Users may select display language such as Chinese, English, Spanish, Russian, Turkey and French.

8.4 EVENT LOG

Users can check event log (max. 99) on this interface, including start/stop info and shutdown alarms.

8.5 MAINTENANCE SETTING

Password is needed for entering maintenance setting. Factory password is 0 (it can be changed, and you need to contact salesman or after-service person). After entering setting maintenance parameters will refresh the maintenance time.

NOTE: It will enter into the next maintenance period after maintenance time due alarm and refreshing the time in the maintenance setting interface.

SmartGen

9 SENSOR SETTING

- 1) When users reselect sensors, the sensor curve will be transferred into the standard value. For example, if temperature sensor is SGH (120°C resistor type), its sensor curve is SGH (120°C resistor type); if users select the SGD (120°C resistor type), the temperature sensor curve is SGD curve.
- 2) If there is difference between standard sensor curve and chosen sensor curve, select “defined sensor”, and then input defined sensor curve.
- 3) When users input the sensor curve, X value (resistor) must be inputted from small to large, otherwise, mistake occurs.
- 4) If there is not oil pressure sensor, but there is low oil pressure alarm switch, users must set the oil pressure sensor as “None”, otherwise, maybe low oil pressure shutdown occurs.
- 5) The headmost or backmost values in the vertical coordinates can be set as the same as below.

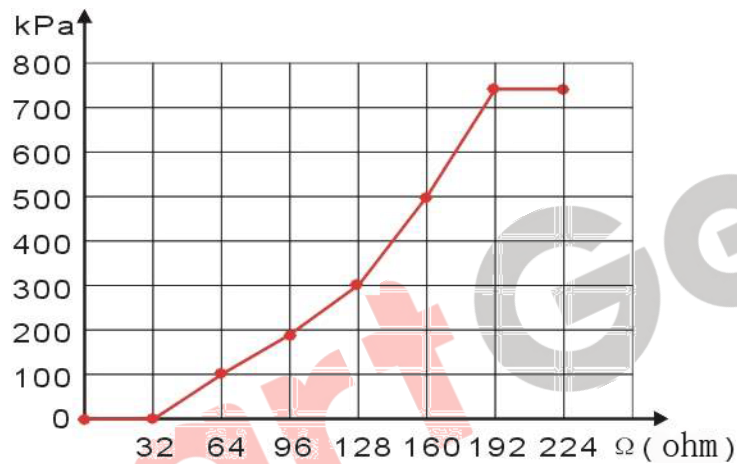

Table 12 Common Unit Conversion Table

	N/m² Pa	kgf/cm²	bar	psi
1Pa	1	1.02×10^{-5}	1×10^{-5}	1.45×10^{-4}
1kgf/cm ²	9.8×10^4	1	0.98	14.2
1bar	1×10^5	1.02	1	14.5
1psi	6.89×10^3	7.03×10^{-2}	6.89×10^{-2}	1

10 COMMISSIONING

Before formal running of system, the following checks are suggested to do.

- 1) Check and ensure all the connections are correct and wires diameter is suitable.
- 2) Ensure that the controller DC power has fuse; battery positive and negative are correctly connected.
- 3) Emergence stop input must be connected to positive of starting battery via normally close contact of emergency stop and fuse.
- 4) Take proper actions to prevent engine to disconnect crank (e. g. Remove the connections of fuel valve). If nothing unusual is found, connect start battery, select Manual Mode, controller will execute the program.
- 5) Set controller as Manual Mode, press “start” button to start genset. If genset goes beyond the setting crank times, controller will send “Failed to Start” signal; then press “stop” to reset controller.
- 6) Recover action of preventing engine to disconnect crank (e. g. Connect wire of fuel valve), press “start” button again, genset will start. If everything goes well, genset will go to normal running after idle running (if configured). During this period, observe engine’s running situation and voltage and frequency of alternator. If something abnormal occurs, stop genset and check all connections according to this manual.
- 7) Select the Auto Mode from front panel, and connect with mains signal. After the mains normal delay, controller will transfer ATS (if configured) into mains load. After cooling, controller will stop genset and go into standby state until mains abnormal occurs again.
- 8) When mains abnormal occurs again, genset will start automatically and go into normal running, send signal to make gens close, transfer ATS and make genset take load. If it is not likes this, please check connections of ATS according to this manual.
- 9) If there are any other questions, please contact SmartGen’s service.

11 TYPICAL APPLICATION

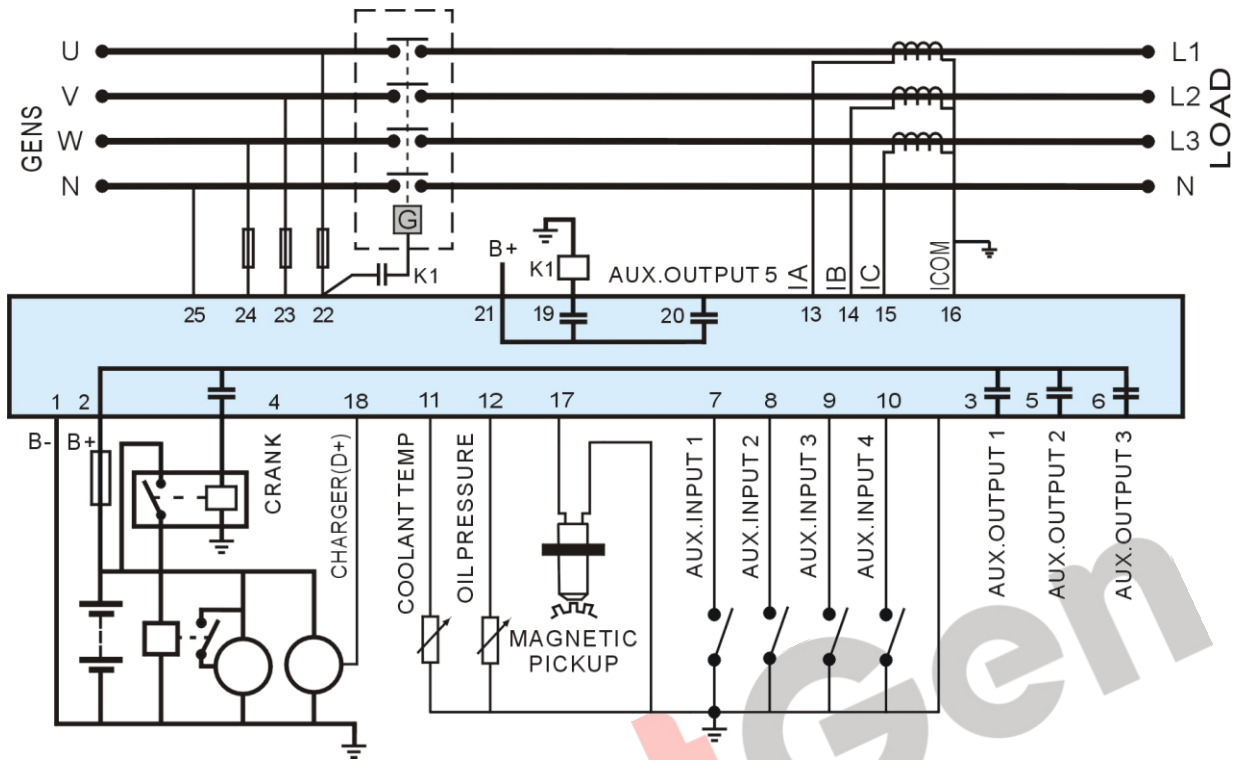

Fig. 4 HGM410N Typical Wiring Diagram

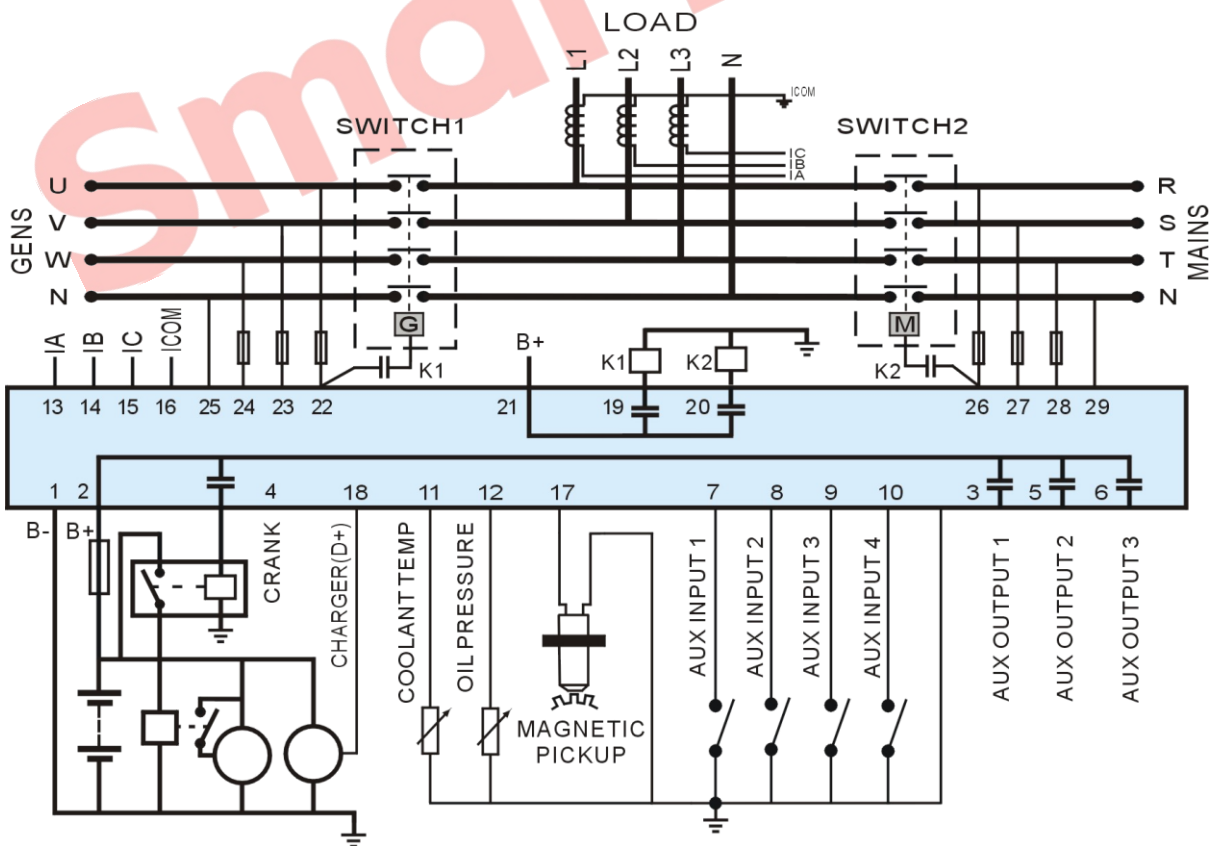

Fig. 5 HGM420N Typical Wiring Diagram

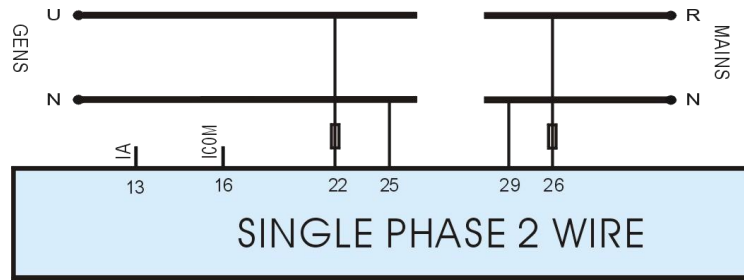

Fig. 6 Single Phase 2 Wire (HGM420N)

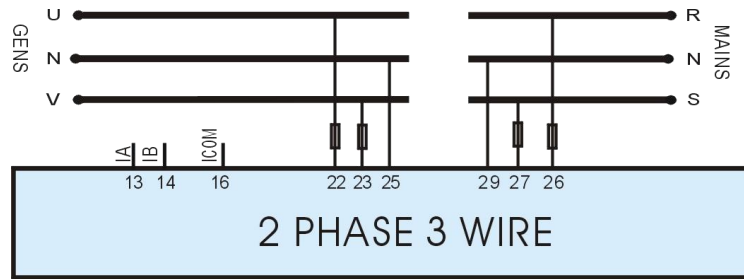

Fig. 7 2 Phase 3 Wire (HGM420N)

!NOTE: It is suggested to expand relay with high capacity for start and fuel outputs.

12 INSTALLATION

12.1 FIXING CLIPS

- 1) The module is designed for panel installation, and fixed by fixing clips.
- 2) Withdraw the fixing clip screw (turn anticlockwise) until it reaches proper position.
- 3) Pull the fixing clip backwards (towards the back of the module) ensuring four clips are inside their allotted slots.
- 4) Turn the fixing clip screws clockwise until they make contact with the panel.

!NOTE: Care should be taken not to over tighten the screws of fixing clips.

12.2 OVERALL DIMENSION AND PANEL CUTOUT

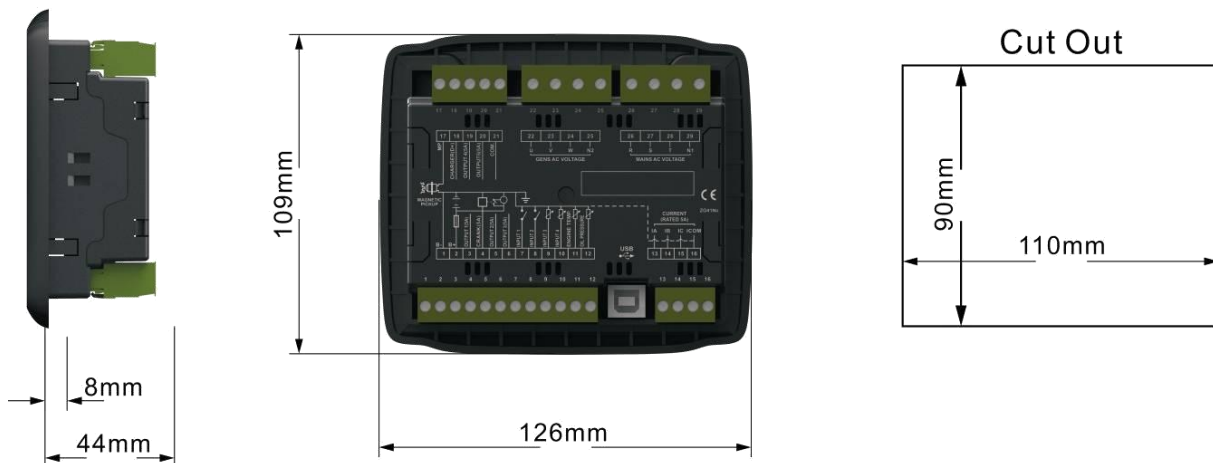

Fig. 8 Case Dimension and Cutout Size

HGM400N series controller can suit for widely range of battery voltage DC(8~35)V. Negative of battery must be connected with the engine shell. The diameter of wire from power supply to battery must be over 2.5mm². If floating charge is configured, please firstly connect output wires of charger to battery's positive and negative directly, then, connect wires from battery's positive and negative to controller's positive and negative input ports in order to prevent charger disturbing the controller's normal working.

1) Speed Sensor Input

Speed sensor is the magnetic equipment installed in starter and for detecting flywheel teeth. Its connection wires to controller should apply 2 cores shielding line. The shielding layer should connect to No. 17 terminal in controller while another side is hanging in air. The other two signal wires are connected to No.1 and No.17 terminals in controller. The output voltage of speed sensor should be within AC(1~24)V (effective value) during the full speed. AC12V is recommended (in rated speed). When the speed sensor is installed, let the sensor is spun to contacting flywheel first, then, port out 1/3 lap, and lock the nuts of sensor at last.

2) Output And Expansion Relay

All outputs of controller are relay contact output type. If it needs to expand the relays, please add freewheel diode to both ends of expand relay's coils (when coils of relay has DC current) or, add resistance-capacitance return circuit (when coils of relay has AC current), in order to prevent disturbance for controller or other equipments.

3) AC Input

HGM400N series controller must be connected to outside current transformer. And the current transformer's secondary side current must be 5A. At the same time, the phases of current transformer and input voltage must be correct. Otherwise, the collected current and active power may be not correct.

NOTE: a. ICOM port must be connected to negative pole of battery.

b. When there is load current, transformer's secondary side is prohibited to open circuit.

4) Withdraw Voltage Test

When controller has been installed on control panel, if it needs to do the high voltage test, please disconnect controller's all terminal connections, in order to prevent high voltage entering controller and damaging it.

13 FAULT FINDING

Table 13 Fault Finding

Symptom	Possible Remedy
Controller no response with power.	Check starting batteries; Check controller connection wirings; Check DC fuse.
Genset shutdown	Check the water/cylinder temperature is too high or not; Check the genset AC voltage; Check DC fuse.
Low oil pressure alarm after crank disconnect	Check the oil pressure sensor and its connections.
High water temp. alarm after crank disconnect	Check the temperature sensor and its connections.
Shutdown alarm during running	Check related switch and its connections according to the information on LCD; Check auxiliary inputs.
Fail to Start	Check fuel circuit and its connections; Check starting batteries; Check speed sensor and its connections; Refer to engine manual.
Starter no response	Check starter connections; Check starting batteries.
Genset running while ATS not transfer	Check ATS; Check the connections between ATS and controllers.