



SmartGen
ideas for power

HGM8100A Genset Controller (HGM8110A/HGM8120A)

(VFD DISPLAY)

USER MANUAL

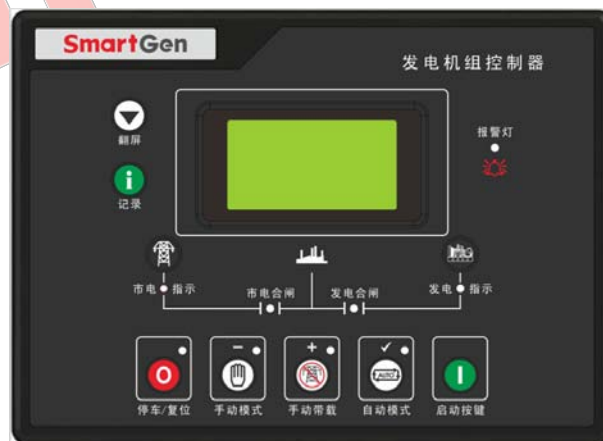
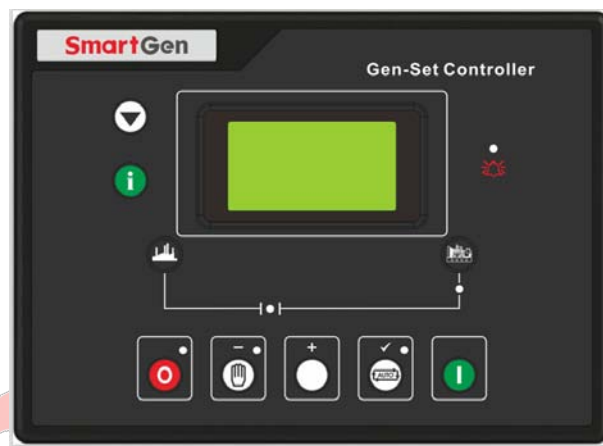

SMARTGEN (ZHENGZHOU) TECHNOLOGY CO., LTD.



Chinese trademark

SmartGen English trademark

SmartGen — make your generator *smart*

SmartGen Technology Co., Ltd.

No.28 Jinsuo Road

Zhengzhou

Henan Province

P. R. China

Tel: 0086-371-67988888/67981888

0086-371-67991553/67992951

0086-371-67981000(overseas)

Fax: 0086-371-67992952

Web: <http://www.smartgen.com.cn>

<http://www.smartgen.cn>

Email: sales@smartgen.cn

All rights reserved. No part of this publication may be reproduced in any material form (including photocopying or storing in any medium by electronic means or other) without the written permission of the copyright holder.

Applications for the copyright holder's written permission to reproduce any part of this publication should be addressed to Smartgen Technology at the address above.



Any reference to trademarked product names used within this publication is owned by their respective companies.

SmartGen Technology reserves the right to change the contents of this document without prior notice.

Software Version

Date	Version	Note
2013-01-29	1.0	Original release.
2013-04-12	1.1	Modify some details.
2013-06-17	1.2	Modify case dimension; Modify the contents of “Oil Pressure Sensor”
2013-11-20	1.3	Add “Loss of Speed Signal Shutdown” in output port settings.
2013-12-23	1.4	Add function: Long pressing “  <p>This manual is suitable for HGM8110A/HGM8120A controller only.</p>

Clarification of notation used within this publication.

SIGN	INSTRUCTION
 NOTE	Highlights an essential element of a procedure to ensure correctness.
 CAUTION!	Indicates a procedure or practice, which, if not strictly observed, could result in damage or destruction of equipment.
 WARNING!	Indicates error operation may cause death, serious injury and significant property damage.

CONTENT

1	OVERVIEW.....	6
2	PERFORMANCE AND CHARACTERISTICS	7
3	SPECIFICATION	10
4	OPERATION.....	11
4.1	KEY FUNCTION	11
4.2	INDICATOR LIGHT	12
4.3	LCD DISPLAY	13
4.3.1	MAIN DISPLAY	13
4.3.2	BASIC PARAMETER	14
4.3.3	ADVANCED PARAMETERS SETTING	16
4.4	AUTOMATIC OPERATION.....	18
4.5	MANUAL OPERATION.....	20
4.6	GENSET CONTROLLER ATS CONTROL PROCEDURES.....	21
4.7	VIEWING THE EVENT LOG.....	23
5	PROTECTION	24
5.1	WARNINGS	24
5.2	SHUTDOWN ALARM.....	26
5.3	TRIP AND STOP ALARM.....	28
5.4	TRIP ALARM.....	29
6	CONNECTING.....	30
7	SCOPES AND DEFINITIONS OF CONFIGURABLE PARAMETERS	33
7.1	CONTENTS AND SCOPES OF PARAMETERS	33
7.2	ENABLE DEFINITION OF PROGRAMMABLE OUTPUT PORTS.....	43
7.2.1	CUSTOM PERIOD OUTPUT	48
7.2.2	CUSTOM COMBINED OUTPUT	49
7.3	DEFINED CONTENTS OF CONFIGURABLE INPUT PORTS (ALL ACTIVE WHEN CONNECT TO GRAND (B-))	50
7.4	SELECTION OF SENSORS.....	53
7.5	CONDITIONS OF CRANK DINSCONNECT SELECTION	54
8	PARAMETER EDITING.....	55
9	SENSORS SETTING.....	57
10	COMMISSIONING	58
11	TYPICAL WIRING DIAGRAMS.....	59
12	INSTALLATION	61

12.1 BATTERY VOLTAGE INPUT.....	61
12.2 SPEED SENSOR INPUT	61
12.3 OUTPUT AND EXPAND RELAYS.....	61
12.4 AC INPUT.....	62
12.5 WITHSTAND VOLTAGE TEST	62
13 FACTORY DEFAULT VALUES.....	63

SmartGen

1 OVERVIEW

HGM8110A/8120A genset controllers are especially designed for extremely high/low temperature environment (-40~+70)°C. The controllers can operate reliability in extreme temperature conditions with the help of VFD display and the components that resist extreme temperature. All display information is Chinese (English is optional). Operation information, status information and faults information are all displayed which make commissioning convenience for factory personnel. Controller can be used under complex electromagnetic interference environment with the strong ability of anti-electromagnetic interference. Easy to maintain and upgrade due to the plug-in terminal.

HGM8110A/8120A genset controllers integrate digitization, intelligentization and network technology which are used for genset automation and monitor control system of single unit to achieve automatic start/stop, data measure, alarm protection and “four remote” (remote control, remote measuring, remote communication and remote regulating).

HGM8110A/8120A genset controllers adopt micro-processor technology with precision parameters measuring, fixed value adjustment, time setting and set value adjusting and etc..Majority parameters can be configured from front panel, and all parameters can be configured by RS485 interface (or RS232) to adjust via PC. It can be widely used in all types of automatic genset control system with compact structure, advanced circuits, simple connections and high reliability.

2 PERFORMANCE AND CHARACTERISTICS

- ◆ HGM8100A series controller has two types:
 - HGM8110A:** ASM (Automatic Start Module), used for single automation systems.
 - HGM8120A:** AMF (Auto Mains Failure), updates based on HGM8110A, moreover, has mains electric quantity monitoring and mains/generator automatic transfer control function, especially for automatic system composed by generator and mains.
- ◆ With ARM-based 32-bit SCM, highly integrated hardware, new reliability level.
- ◆ Vacuum fluorescent display (VFD), selectable Chinese/English interface which can be chosen at the site, making commissioning convenience for factory personnel;
- ◆ Widely temperature range: (-40~70) °C, can be used in extreme temperature environment.
- ◆ Suitable for 3-phase 4-wire, 3-phase 3-wire, single phase 2-wire, and 2-phase 3-wire systems with voltage 120/240V and frequency 50/60Hz;
- ◆ Collects and shows 3-phase voltage, current, power parameter and frequency of generator or mains.

Mains

Line voltage (Uab, Ubc, and Uca)	V (unit)
Phase voltage (Ua, Ub, and Uc)	V (unit)
Frequency f	Hz(unit)

Generator

Line voltage (Uab, Ubc, and Uca)	V (unit)
Phase voltage (Ua, Ub, and Uc)	V (unit)
Frequency f	Hz(unit)

Load

3-phase Current	Ia, Ib, Ic	A (unit)
Active power (P)		kW (unit)
Apparent power (S)		kVA (unit)
Power factor (λ)		
Accumulate total generator power (W)		kWh(unit)

- ◆ For Mains, controller has over and under voltage, over and under frequency, loss of phase and phase sequence wrong detection functions; For generator, controller has over and under voltage, over and under frequency, loss of phase, phase sequence

wrong, over and reverse power, over current detection functions;

- ◆ 3 fixed analog sensors (temperature, oil pressure and liquid level);
- ◆ 2 configurable sensors can be set as sensor of temperature, oil pressure or fuel level;
- ◆ Precision measure and display parameters about Engine,

Temp. (WT) °C/°F both be displayed

Oil pressure (OP) **kPa/psi/bar** all be displayed

Speed (RP)

Voltage of Battery (VB) **V (unit)**

Voltage of Charger (VD) **V (unit)**

Hour count (HC) can accumulate to max. 65535 hours.

Start times can accumulate to max. 65535 times.

- ◆ Protection: automatic start/stop of the gen-set, ATS(Auto Transfer Switch) control with perfect fault indication and protection function;

Fault display items:

High temperature alarm

High temperature shutdown

Low oil pressure alarm

Low oil pressure shutdown

Over speed shutdown

Low fuel level warn

Battery voltage high warn

Battery voltage low warn

Over current shutdown

Fail to start

Fail to stop

Emergency stop alarm

Oil pressure sensor open circuit shutdown

Temperature sensor open circuit shutdown

- ◆ All output ports are relay-out;
- ◆ Parameter setting: parameters can be modified and stored in internal EEPROM memory and cannot be lost even in case of power outage; most of them can be adjusted using front panel of the controller and all of them can be modified using PC via RS485/RS232 ports.
- ◆ More kinds of curves of temperature, oil pressure, fuel level can be used directly and

users can define the sensor curves by themselves;







- ◆ Multiple crank disconnect conditions (speed sensor, oil pressure, generator frequency) are optional;
- ◆ Real time clock and run time accumulation function. 99 pieces of event logs can be circularly stored and inquired on the spot; also can be print or be inquired via PC.
- ◆ Scheduled start & stop generator (can be set as start genset once a week/month).
- ◆ With maintenance function. Actions (warning, shutdown or trip and stop) can be set when maintenance time out;
- ◆ Can be used on pumping units and as an indicating instrument (indicate and alarm are enable only, relay is inhibited);
- ◆ Accumulative total electric energy. Users can reset it and re-accumulative the value which make convenience to users to count the total value as their wish.
- ◆ Widely Power supply range: DC(8~35)V, suitable to 12/24V start battery voltage environment.
- ◆ With international standard MODBUS communication protocol, better error checking capability, and with RS232 and RS485(coupling isolation) communication interface, can realized functions of remote control, remote measuring, remote communication and remote regulating.
- ◆ Waterproof security level IP55 due to rubber seal installed between the controller enclosure and panel fascia;
- ◆ Metal fixing clips enable perfect in high temperature environment;
- ◆ Modular design, pluggable connection terminals and embedded installation way; compact structure with easy mounting.



3 SPECIFICATION

ITEM	CONTENT
Operating voltage	DC8. 0V to 35. 0V, Continuous Power Supply
Power consumption	<6W(Standby mode: ≤3W)
Alternator Input Range 3-Phase 4 Wire 3-Phase 3 Wire Single-Phase 2 Wire 2-Phase 3 Wire	AC20V - AC360V (ph-N) AC30V - AC600V (ph- ph) AC20V - AC360V (ph-N) AC20V - AC360V (ph-N)
Alternator Frequency	50Hz / 60Hz
Speed sensor voltage	1.0V to 24.0V (RMS)
Speed sensor Frequency	10,000 Hz (max)
Start Relay Output	16 A DC28V at DC supply output.
Fuel Relay Output	16 A DC28V at supply output.
Aux. Output 1	16 A DC28V at supply output.
Aux. Output 2	16 A DC28V at supply output.
Aux. Output 3	16 A DC28V at supply output.
Aux. Output 4	16 A AC250V at DC supply output.
Gen Close Relay Aux. Output 5	16A AC250V passive
Mains Close Relay Aux. Output 6	16A AC250V passive
Overall Dimensions	243.7mm x 176.2mm x 51.2mm
Panel Cutout	214mm x 160mm
C. T. Secondary	5A (rated)
Working Conditions	Temperature: (-40~+70)°C Humidity: (20~93)%RH
Storage Condition	Temperature: (-40~+70)°C
Protective Level	IP55 Gasket
Insulation Intensity	Apply AC2.2kV voltage between high voltage terminal and low voltage terminal; The leakage current is not more than 3mA within 1min.
Weight	0.80kg

4 OPERATION

4.1 KEY FUNCTION

Symbol	Key Type	Description
	Stop/ Reset	Stop running generator in Auto/Manual mode; Lamp test (press at least 3 seconds); Reset alarm in stop mode; During stopping process, press this button again to stop generator immediately.
	Start	Start genset in Manual/Test mode.
	Manual mode / Config. '-'	Pressing this key will set the module into manual mode. In setting parameter status, press this key will decrease setting value.
	Test mode/ Config. '+'	Pressing this key will set the module into test mode (only for HGM8120A). In setting parameter status, press this key will increase setting value.
	Auto mode/Confirm	Pressing this key will set the module into auto mode. In setting parameter status, press this key will right shift cursor or confirm setting value.
	Event log	Pressing this key will view shutdown history records. Again pressing this key will exit. When there is trip alarm occurs, pressing and holding this button for more than 3 seconds can reset the alarm.
	Page Down	Screen scroll in parameters interface or event log interface;

NOTE: In manual mode, pressing  and  simultaneously will force generator to crank. Successful start will not be judged according to crank disconnect conditions, operator will have to crank the starter motor manually; when operator decides that the engine has fired, he/she should release the button and start relay will be deactivated, safety on delay will start.

NOTE: Pressing and holding  for more than 3 seconds enters basic parameter configuration menu;

NOTE: Pressing  and  enters advanced parameter configuration menu;

WARNING: Default password is 00318, user can change it in case of others change the advanced parameters setting. Please clearly remember the password after changing. If you forget it, please contact Smartgen services.

4.2 INDICATOR LIGHT

Alarm indicator:

Alarm Type	Alarm Indicator
Warning	Slow flashing (1 time per sec)
Trip Alarm	Slow flashing (1 time per sec)
Shutdown Alarm	Fast flashing (5 times per sec)
Trip and Stop Alarm	Fast flashing (5 times per sec)

Generator normal light: It is light on when generator is normal; flashing when generator state is abnormal; off when there is no generator power.

Mains normal light: It is light on when mains is normal; flashing when mains state is abnormal; off when there is no mains power.

Generator close light: It is light on when generator close; off when generator open.

Mains close light: It is light on when mains close; off when mains open. (HGM8120A)

SmartGen

4.3 LCD DISPLAY

4.3.1 MAIN DISPLAY

Main screen is used to display real time data of all parameters, use  to scroll the screen.

★**Status**, including as below,

Status of genset, mains (HGM8120A), and ATS

★**Mains**, including as below

Phase voltage, Line voltage, frequency

▲**NOTE:** HGM8110A has no mains status screen.

★**Gen**, including as below,

Phase voltage, Line voltage, frequency

★**Load**, including as below,

Current, each phase and total active power (positive and negative), total apparent power, average power factor (positive and negative), accumulated energy (**kWh, kVarh, kVAh**).

▲**Note:** When mains close indicator lights, count active and inactive power, apparent power, power factor, but accumulate electric energy. Counting the generator active and reactive power, apparent power, power factor, and accumulate electric energy under other conditions.

▲**NOTE:** Power factor shows as following,

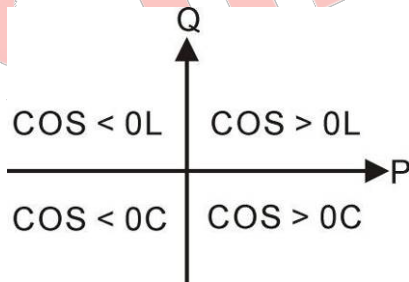

Remark:

P stands for active power

Q stands for inactive power

Power factor	Conditions	Active power	Inactive power	Remark
COS>0L	P>0,Q>0	Input	Input	Load is inductive resistance.
COS>0C	P>0,Q<0	Input	Output	Load is capacitance resistance.
COS<0L	P<0,Q>0	Output	Input	Load equal to one under excitation generator
COS<0C	P<0,Q<0	Output	Output	Load equal to one over excitation generator.

Note:

1. Input active power, generator or mains supply electricity to load.
2. Output active power, load supply electricity to generator or mains.
3. Input reactive power, generator or mains send reactive power to load.
4. Output reactive power, load send reactive power to generator or mains.

★**Engine**, including as below,

Speed, engine temperature, engine oil pressure, liquid (fuel) level, flexible sensor 1, flexible sensor 2, battery voltage, charger voltage, accumulated run time, accumulated start times.

★**Alarm:**

Display all kinds of alarm information, such as Gen Overvolts, Gen Undervolts, Gen Over Frequency, Gen Under Frequency and so on.

★**Event log**

Records all start/stop events (shutdown alarm, trip and stop alarm, manual /auto start or stop) and the real time when alarm occurs.

Example:

Gen			
UL-L	0	0	0V
UL-N	0	0	0V
F = 0.0Hz			0rpm
Stop Mode			

Load			
Current	0.0	0.0	0.0A
Power	0.0kW	0.0	kVA
cosΦ = 0.00		0.0	kVar
Gen Overvolts Warn			





4.3.2 BASIC PARAMETER





Basic parameters setting Including as following,





- Mains Rated Voltage (HGM8120A)
- Mains Rated Frequency (HGM8120A)
- Crank Disconnect

- Flywheel Teeth
- Gen Rated Speed
- Gen Rated Voltage
- Gen Rated Frequency
- CT Ratio
- Rated Current
- Rated Power
- Battery Voltage
- Date and Time
- Start Delay
- Stop Delay
- Pre-heat Delay
- Cranking Time
- Crank Rest Time
- Safety On Delay
- Start Idle Time
- Warming Up Time
- Cooling Time
- Stop Idle Time
- ETS Solenoid Hold
- Fail to Stop Delay
- After Stop Time

Example:

Basic Parameter Setting >Return > Mains Rated Frequency > Crank Disconnect	Form1:   are used for changing the setting contents.  to enter settings (form2),  to exit settings menu.
---	--

Crank Disconnect 2: Speed sensor + Gen freq.	Form 2: Press  to enter settings (form 3); press  or  or  to return to previous menu. (Form 1).
---	---





Crank Disconnect 2: Speed sensor + Gen freq.	Form 3:   are used for changing the setting contents.  Confirm setting (form 2),  exit setting (form 2).
---	--





4.3.3 ADVANCED PARAMETERS SETTING





Advanced parameter setting Including as following,





- Mains settings
- Timer settings
- Engine settings
- Generator settings
- Load settings
- Switch settings
- Analog sensor settings
- Input port settings
- Output port settings
- Module settings
- Scheduling and maintenance settings





Example,





Advanced Parameters Setting >Mains >Timers >Engine >Generstor	Form1:   are used for changing the setting contents.  to enter settings (form2),  to exit settings menu.
---	--





Engine Setting >Return >AC System >Poles >Rated Voltage	Form 2:   are used for changing the setting contents (form 3). Select "Return" and press  to return to previous menu (form 1). Press  also can return to previous menu (form 1)
---	---





Generator Setting >Gen Undervolt Shutdown > Gen Overfreq. Shutdown > Gen Underfreq. Shutdown > Gen Overvolt Warn	Form 3:   are used for changing the setting contents.  Confirm setting (form 4),  exit setting (form 1).
--	--

Overvolt Warn Sel: Disable Set Value: 00110% Return Value: 00108% Delay: 00005	Form 4: Press  to enter settings (form 5); Press  or  or  to return to previous menu. (Form 3).
--	---

Overvolt Warn Sel: Disable Set Value: 00110% Return Value: 00108% Delay: 00005	Form 5:   are used for changing the setting contents (form 6).  Confirm setting (form 7),  return to previous menu (form 4)
--	--

Overvolt Warn Sel: Disable Set Value: 00110% Return Value: 00108% Delay: 00005	Form 6:   are used for changing the setting contents (form 5).  Confirm setting (form 7),  return to previous menu (form 4)
--	--

Overvolt Warn Sel: Enable Set Value: 00000 Return Value: 00108% Delay: 00005	Form 7:   are used for changing the setting contents (form 5).  Confirm setting,  return to previous menu (form 4).
--	---

Overvolt Warn Sel: Enable Set Value: 0000 Return Value: 00108% Delay: 00005	Form 8:   are used for changing the setting contents.  Confirm setting (form 4),  return to previous menu (form 4).
---	---

▲NOTE: Pressing and holding  for a long time can exit setting directly during setting.

4.4 AUTOMATIC OPERATION

Press , its indicator lights, and controller enters **Auto** mode.

Starting Sequence,

1. **HGM8120A:** When Mains is abnormal (over and under voltage, over and under frequency), it enters into mains “abnormal delay” and VFD display count down time. When mains abnormal delay is over, it enters into “start delay”;
2. **HGM8110A:** Generator enters into “start delay” as soon as “Remote Start” is active.
3. “Start Delay” timer is shown on VFD display.
4. When start delay is over, preheat relay outputs (if this be configured), “preheat delay XX s” is shown at the bottom line of VFD.
5. When preheat delay is over, fuel relay outputs 1s and then start relay output; if engine crank fails during “cranking time”, the fuel relay and start relay deactivated and enter into “crank rest time” to wait for next crank.
6. If engine crank fails within setting times, the controller sends Fail to Start signal and Fail To Start message appears on VFD alarm page.
7. In case of successful crank attempt, “safety on” timer starts. During this period, low oil pressure, high water temperature, under speed, charge failure alarms and Aux. input (if configured) are disabled. As soon as this delay is over, “start idle delay” is initiated (if configured).
8. During “start idle delay”, under speed, under frequency, under voltage alarms are inhibited. When this delay is over, “warming up delay” starts (if configured).
9. When “warming up delay” is over, if generator state is normal, its indicator will be illuminated. If voltage and frequency has reached on-load requirements, the closing relay will be energised, generator will accept load, generator power indicator will turn on, and generator will enter Normal Running state; if voltage and frequency are abnormal, the controller will initiate alarm (alarm type will be displayed on VFD display).

▲NOTE: In case of “Remote Start (off Load)”, the procedure is the same, except for step NO. 9: the closing relay will NOT be energised, generator will NOT accept load.

Stopping Sequence









- 1) HGM8120A: If mains turns normal during genset is running, enter into mains voltage “normal delay” and its indicator illuminates after mains is confirmed normally, “Start delay” is beginning.
- 2) HGM8110A: Genset enters into “stop delay” as soon as “Remote Start” input is

inactive.

- 3) HGM8120A: After stop delay ends, enter “cooling time”, and generator close relay is disconnected, after “switch transfer delay”, mains close relay output, mains is on-load, generator power supply indicator is extinguishing, and mains power supply indicator is illuminates.
- 4) Idle relay is output when the controller enters “idle stop delay”.
- 5) Enter into “ETS delay” and ETS relay is active. Fuel relay output is disconnected.
- 6) Genset can automatically judge if it is steady when the controller enters “Genset after stop time”.
- 7) After genset stops steadily, enter generator standby status; if genset does not stop, then controller will alarm (VFD screen display stop failure warn).
- 8) Enter “generator at rest” as soon as “after stop time” is over.

SmartGen

4.5 MANUAL OPERATION

- 1) **HGM8120A:** “Manual Mode” is active when press  key and its indicator illuminates. Press  key, then controller enters “**Test Mode**” and indicator illuminates. Under the both modes, press  key to start genset, and it automatically detects if it starts successfully and accelerate high speed running. With high temperature, low oil pressure, over speed and abnormal voltage during diesel genset running, controller can protect genset to stop effectively and quickly (please refer to No.4~9 of **Starting Sequence** for more details). Under “**Manual Mode**  ”, genset on-load is decided by whether mains are normal or not. If mains are normal, loading switch isn’t transferred; while mains are abnormal, loading switch is transferred into generator’s side. Under “**Test Mode**  “, after genset runs well in high speed, no matter mains is normal or not, loading switch must be transferred into Generator’s side.
- 2) **HGM8110A:** “**Manual Mode**” is active when press  key, and its indicator is illuminates. Then press  key to start generator, it automatically detects if it is started successfully and genset automatically accelerates high speed running. With high temperature, low oil pressure, over speed and voltage abnormal during diesel genset running, controller can protect genset to stop effectively and quickly (please refer to No.4~9 of **Starting Sequence** for more details). After genset runs well in high speed, controller will send signal of Generator close.
- 3) Manual stop: press  key can shutdown the running genset (please refer to No.3~7 of **Stopping Sequence** for more details).

4.6 GENSET CONTROLLER ATS CONTROL PROCEDURES

1. HGM8120A ATS CONTROL PROCEDURES

1) If input port is configured as Closed Auxiliary (Mains Closed Auxiliary/ Gen Closed Auxiliary)

A. If “Open breaker detect” is “SELECT Enable”

When transferring load from mains to generator, controller begins detecting “fail to transfer”, then the open delay and transfer rest delay will begin. When detecting time out, if switch open failed, the generator will not switch on, otherwise, generator switch on. Detecting transfer failure while generator switch on. When detecting time out, if switch on fail, it is need to wait for generator to switch on. If transfer failed and warning “SELECT Enable”, there is alarming signal whatever switch on or off failure.

The way to transfer from generator load to mains load is as same as above.

B. If “Open breaker detect” is “SELECT Disable”

Mains load is transferred into generator load, after the delay of switch off and transfer interval, generator switch on. Detecting transfer fail while generator switch on. After detecting time out, if switch on fail, then wait for generator switch on. If transfer fail and warning “SELECT Enable”, there is alarming signal.

2) If input port is not configured as Close Mains Auxiliary

Mains load is transferred into generator load, after switch off and transfer interval delay, generator switch on.

The way to transfer generator load to mains load is as same as above.

2. HGM8110A ATS CONTROL PROCEDURES

1) If input port is configured as Gen Closed Auxiliary

A. If “Open breaker detect” is “SELECT Enable”

Generator load is transferred into generator un-load, after the delay of switch off, detecting transfer failure while switch off output. When detecting time out, if switch off failed, it will wait for switch off. Otherwise, switch off is completed.

Generator unload is transferred into generator load, after the delay of switch on, detecting transfer failure while switch on outputting. When detecting time out, if switch on failed, it will wait for switch on. Otherwise, switch on is completed.

If transfer failed and warning “SELECT Enable”, there is alarming signal whatever switch on or off failure.

B. If “Open breaker detect” is “SELECT Disable”

Generator load is transferred into generator unload, after the delay of switch off, switch off is completed.

Generator unload is transferred into generator load, after the delay of switch on, detecting transfer failure while switch on outputting. When detecting time out, if switch on failed, to wait for switch on. Otherwise, switch on is completed.

If transfer failure warning is "SELECT Enable", there is warning signal that "switch on fail".

2) If input port is not configured as Gen Closed Auxiliary

Generator un-load is transferred into generator load, close generator output.

Generator load is transferred into generator un-load, open generator output.



▲NOTE:

When using ATS of no interposition, switch off detecting should "SELECT Disable";

When using ATS of having interposition, switch off "SELECT Disable" or "SELECT Enable" both are OK. If choose "SELECT Enable", switch off output should be configured;

When using AC contactor, switch off "SELECT Enable" is recommended.

4.7 VIEWING THE EVENT LOG

In the control panel, press  key to view previous running records of the controller, including all start/stop records (shutdown, trip and stop, manual/auto start/stop) and corresponding time. Press  key to view records backward. Again press  key to return real time display status of the controller. HGM8100A controller can save recent 99 pieces event log records.

SmartGen

5 PROTECTION

5.1 WARNINGS

When controllers detects the warning signal, alarm only and not stop the genset, besides, the VFD displays the warning information.

Warnings as following,

No.	Type	Description
1	Over Speed Warn	When controller detects the speed is higher than the set value, it will send warn signal.
2	Under Speed Warn	When controller detects the speed is lower than the set value, it will send warn signal.
3	Loss of Speed Signal Warn	When controller detects the speed is 0 and the action select "Warn", it will send warn signal.
4	Over Frequency Warn	When controller detects the frequency is higher than the set value, it will send warn signal.
5	Under Frequency Warn	When controller detects the frequency is lower than the set value, it will send warn signal.
6	Over Voltage Wan	When controller detects the voltage is higher than the set value, it will send warn signal.
7	Under Voltage Warn	When controller detects the voltage is lower than the set value, it will send warn signal.
8	Over Current Warn	When controller detects the current is higher than the set value, it will send warn signal.
9	Fail to Stop	When generator not stops after the "stop delay" is over.
10	Charge Alt Fail	When controller detects the charger voltage is lower than the set value, it will send warn signal.
11	Battery Over Voltage	When controller detects the battery voltage is higher than the set value, it will send warn signal.
12	Battery Under Voltage	When controller detects the battery voltage is lower than the set value, it will send warn signal.
13	Maintenance Due	When count down time is 0 and the action select "Warn", it will send warn signal.
14	Reverse Power	When controller detects the reverse power value (power is negative) is lower than the set value, it will send warn signal.
15	Over Power	When controller detects the reverse power value (power is positive) is higher than the set value, it will send warn

No.	Type	Description
		signal.
16	Gen Loss of Phase	When controller detects the generator loss phase, it will send warn signal.
17	Gen Phase Sequence Wrong	When controller detects the reverse phase, it will send warn signal.
18	Switch Fail Warn	When controller detects the switch on and off fail, and the action select enable, it will send warn signal.
19	Temp. Sensor Open	When controller detects the sensor is open circuit, and the action select "warn", it will send warn signal.
20	High Temp. Warn	When controller detects the temperature is higher than the set value, it will send warn signal.
21	Low Temp. Warn	When controller detects the temperature is lower than the set value, it will send warn signal.
22	Pressure Sensor Open	When controller detects the sensor is open circuit, and the action select "warn", it will send warn signal.
23	Low OP Warn	When controller detects the oil pressure is lower than the set value, it will send warn signal.
24	Level Sensor Open	When controller detects the sensor is open circuit, and the action select "warn", it will send warn signal.
25	Low Level Warn	When controller detects the oil lever is lower than the set value, it will send warn signal.
26	Flexible Sensor 1 Open	When controller detects the sensor is open circuit, and the action select "warn", it will send warn signal.
27	Flexible Sensor 1 High	When controller detects the sensor value is higher than the max. set value, it will send warn signal.
28	Flexible Sensor 1 Low	When controller detects the sensor value is lower than the min. set value, it will send warn signal.
29	Flexible Sensor 2 Open	When controller detects the sensor is open circuit, and the action select "warn", it will send warn signal.
30	Flexible Sensor 2 High	When controller detects the sensor value is higher than the max. set value, it will send warn signal.
31	Flexible Sensor 2 Low	When controller detects the sensor value is lower than the min. set value, it will send warn signal.
32	Digital Input Warn	When digit input port is set as warning and active, controller sends corresponding warning signal.

5.2 SHUTDOWN ALARM

When controller detects shutdown alarm, it will send signal to stop the generator.

Shutdown alarms as following,

No.	Type	Description
1	Emergency Stop	When controller detects emergency stop signal, it will send stop signal.
2	Over Speed	When controller detects the speed value is higher than the set value, it will send stop signal.
3	Under Speed	When controller detects the speed value is lower than the set value, it will send stop signal.
4	Loss Of Speed Signal	When controller detects speed value equals to 0, and the action select "Shutdown", it will send stop signal
5	Over Frequency	When controller detects the frequency value is higher than the set value, it will send stop signal.
6	Under Frequency	When controller detects the frequency value is lower than the set value, it will send stop signal.
7	Over Voltage	When controller detects the voltage value is higher than the set value, it will send stop signal.
8	Under Voltage	When controller detects the voltage value is lower than the set value, it will send stop signal.
9	Fail To Start	If genset start failure within setting of start times, controller will send stop signal.
10	Over Current	When controller detects the current value is higher than the set value, it will send stop signal.
11	Maintenance Due	When count down time is 0 and the action select "Shutdown", it will send stop signal.
12	Reverse Power Shutdown	When controller detects reverse power value (power is negative) is lower than the set value, and the reverse power action select "shutdown", it will send stop signal.
13	Over Power Shutdown	When controller detects reverse power value (power is positive) is higher than the set value, and the reverse power action select "shutdown", it will send stop signal.
14	Temp. Sensor Open	When controller detects sensor is open circuit, and the action select "shutdown", it will send stop signal.
15	High Temp. Shutdown	When controller detects temperature is higher than the set value, it will send stop signal.

No.	Type	Description
16	Pressure Sensor Open	When controller detects sensor is open circuit, and the action select "shutdown", it will send stop signal.
17	Low OP Shutdown	When controller detects oil pressure is lower than the set value, it will send stop signal.
18	Level Sensor Open	When controller detects sensor is open circuit, and the action select "shutdown", it will send stop signal.
19	Flexible Sensor 1 Open	When controller detects sensor is open circuit, and the action select "shutdown", it will send stop signal.
20	Flexible Sensor 1 High	When controller detects the sensor value is higher than the max. set value, it will send stop signal.
21	Flexible Sensor 1 Low	When controller detects the sensor value is lower than the min. set value, it will send stop signal.
22	Flexible Sensor 2 Open	When controller detects sensor is open circuit, and the action select "shutdown", it will send stop signal.
23	Flexible Sensor 2 High	When controller detects the sensor value is higher than the max. set value, it will send stop signal.
24	Flexible Sensor 2 Low	When controller detects the sensor value is lower than the min. set value, it will send stop signal.
25	Digital Input Port	When digital input port is set as shutdown, and the action is active, it will send stop signal.

5.3 TRIP AND STOP ALARM

When controller detects trip and stop alarm signal, it will shutdown generator quickly and stop after high speed cooling.

Trip and stop alarm as following,

No.	Type	Description
1	Over Current	When controller detects the value is higher than the set value, and the action select "trip and stop", it will send trip and stop signal.
2	Maintenance Due	When count down time is 0 and the action select "trip and stop", it will send a trip and stop signal.
3	Reverse Power	When controller detects reverse power value (power is negative) is lower than the set value, and the action select "trip and stop", it will send a trip and stop signal.
4	Over Power	When controller detects the over power value (power is positive) is higher than the set value, and the action select "trip and stop", it will send a trip and stop signal.
5	Digital Input Ports	When digital input port is set as "trip and stop", and the action is active, it will send a trip and stop signal.

5.4 TRIP ALARM

When controller detects trip alarm, it will break close generator signal quickly, but genset not stop.

Trip alarm as following,

No.	Type	Description
1	Over Current	When controller detects the value is higher than the set value, and the action select "trip", it will send trip signal.
2	Reverse Power	When controller detects reverse power value (power is negative) is lower than the set value, and the action select "trip", it will send a trip signal.
3	Over Power	When controller detects the over power value (power is positive) is higher than the set value, and the action select "trip", it will send a trip signal.
4	Digital Input Ports	When digital input port is set as "trip", and the action is active, it will send a trip signal.

SmartGen

6 CONNECTING

Compared with HGM8120A, HGM8110A has no 31~34 terminals. The back panel of HGM8110A and HGM8120A controller is shown as follows:

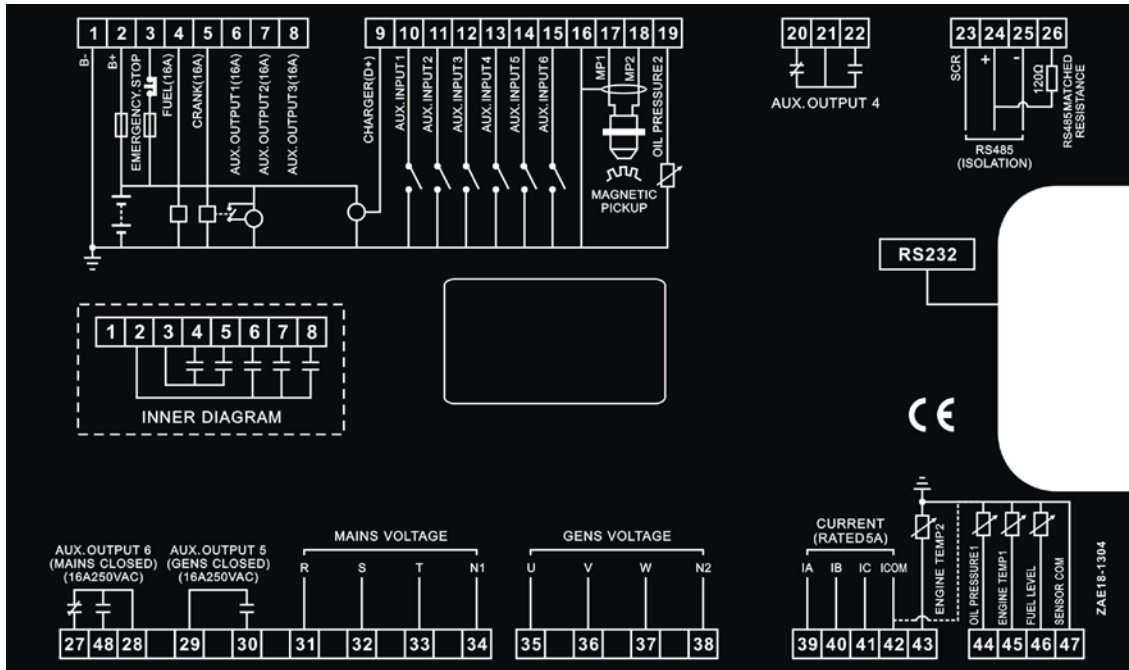

No.	Function	Cable Size (mm ²)	Remarks
1	DC input B-	2.5	Connected with negative of starter battery.
2	DC input B+	2.5	Connected with positive of starter battery. Max. 20A fuse is recommended.
3	Emergency stop	2.5	Connected with DC power supply via emergency stop button. Also supply power to fuel relay and start relay. Max. 30A fuse is recommended.
4	Fuel relay output	2.5	DC power is supplied by 3 terminal, rated 16A
5	Start relay output	2.5	DC power is supplied by 3 terminal, rated 16A
6	Aux. Output 1	2.5	B+ output, rated 16A
7	Aux. Output 2	2.5	B+ output, rated 16A
8	Aux. Output 3	2.5	B+ output, rated 16A
			Details see form 2
9	Charger(D+)	1.0	Connected with charger starter's D+ terminal. Ground connected is not allowed.
10	Aux. Input 1	1.0	Ground connected

No.	Function	Cable Size (mm ²)	Remarks
			is active (B-)
11	Aux. Input 2	1.0	Ground connected is active (B-)
12	Aux. Input 3	1.0	Ground connected is active (B-)
13	Aux. Input 4	1.0	Ground connected is active (B-)
14	Aux. Input 5	1.0	Ground connected is active (B-)
15	Aux. Input 6	1.0	Ground connected is active (B-)
16	Magnetic Pickup	1.0	Common grounded; Connected with enclosure or negative of starter battery.
17	Magnetic Pickup +	1.0	Connected to speed sensor
18	Magnetic Pickup -	1.0	
19	Oil Pressure sensor 2 input	1.0	Oil pressure sensor input, can be connected to an external resistance sensor. (Also can be set as Temperature sensor or Fuel level sensor).
20	Aux. Output 4	2.5	Volts free contactors, rated 16A. Details see form 2
21			
22			
23	RS485	0.5	Opto-isolation; (Impedance-120Ω shielding wire is recommended, its single-end earthed. Hang up the 26 terminal.)
24	RS485+	0.5	
25	RS485-	0.5	
26	Matched Resistance		If needed, please make this terminal and 25 terminal short circuit. If not, hang it in the air.
27	Aux. Output 6	2.5	Control mains to take load. Volts free contactor. Rated 16A. (Also can be set as other function; Details see form 2).
28	Mains Close Relay		
48	Output		
29	Aux. Output 5	2.5	Control generator to take load. Normally open volts free contactor. Rated 16A. (Also can be set as other function; Details see form 2)
30	Gen Close Relay Output		
31	Mains A-phase voltage sensing input	1.0	Connected to A-phase of mains (2A fuse is recommended) (HGM8110A without)
32	Mains B-phase voltage sensing input	1.0	Connected to B-phase of mains (2A fuse is recommended) (HGM8110A without)
33	Mains C-phase voltage sensing input	1.0	Connected to C-phase of mains (2A fuse is recommended) (HGM8110A without)

No.	Function	Cable Size (mm ²)	Remarks
34	Mains N-wire input	1.0	Connected to N-wire of mains (HGM8110A without)
35	Genset A-phase voltage sensing input	1.0	Connected to A-phase of gen-set (2A fuse is recommended)
36	Genset B-phase voltage sensing input	1.0	Connected to B-phase of gen-set (2A fuse is recommended)
37	Genset C-phase voltage sensing input	1.0	Connected to C-phase of gen-set (2A fuse is recommended)
38	Genset N-wire input	1.0	Connected to N-wire of gen-set
39	CT A-phase sensing input	2.5	Outside connected to secondary coil of current transformer(rated 5A)
40	CT B-phase sensing input	2.5	Outside connected to secondary coil of current transformer(rated 5A)
41	CT C-phase sensing input	2.5	Outside connected to secondary coil of current transformer(rated 5A)
42	CT COM	2.5	Common grounded; Connected with negative of starter battery.
43	Temperature sensor 2	1.0	Temperature sensor input, can be connected to an external resistance sensor. (Also can be set as Oil Pressure sensor or Fuel level sensor).
44	Oil pressure sensor 1	1.0	Oil pressure sensor input, can be connected to an external resistance sensor.
45	Temperature sensor 1	1.0	Temperature sensor 1 input, can be connected to an external resistance sensor.
46	Fuel level sensor	1.0	Fuel level sensor input, can be connected to an external resistance sensor.
47	Sensor COM	/	Public terminal of sensor, (B-) has already connected.
	RS232 connectors	0.5	Communication with the computer (2-RXD、3-TXD、5-GND)

Note: Prohibit removing starting battery when the engine is running, or it will damage the control system because of over DC input voltage.

7 SCOPES AND DEFINITIONS OF CONFIGURABLE PARAMETERS

HGM8110A/8120A generator controllers can set the following parameters, (HGM8110 has no mains items)

7.1 CONTENTS AND SCOPES OF PARAMETERS

FORM 1

No.	Items	Parameters	Defaults	Description
Mains Setting				
1	AC System	(0~3)	0	0: 3P4W; 1: 3P3W; 2: 2P3W; 3: 1P2W.
2	Rated Voltage	(30~30000)V	230	Standard for checking mains over/under voltage. (It is primary voltage when using voltage transformer.)
3	Rated Frequency	(10.0~75.0) Hz	50.0	Standard for checking mains over/under frequency.
4	Normal Time	(0~3600)s	10	The delay from mains abnormal to normal.
5	Abnormal Time	(0~3600)s	5	The delay from mains normal to abnormal.
6	Volt. Trans.(PT)	(0~1)	0	0: Disable ; 1: Enable
7	Over Voltage	(0~1000)%	120%	Setting value is mains rated voltage's percentage, and return value and delay value can be set.
8	Under Voltage	(0~1000)%	80%	Setting value is mains rated voltage's percentage, and return value and delay value can be set.
9	Over Frequency	(0~1000)%	Disable	Setting value is mains rated frequency's percentage, return value and delay value can be set.
10	Under Frequency	(0~1000)%	Disable	Setting value is mains rated frequency's percentage. Return value and delay value can be set.
11	Loss Phase of	(0~1)	1	0: Disable; 1: Enable
12	Reverse Phase	(0~1)	1	

No.	Items	Parameters	Defaults	Description
Timer Setting				
1	Start Delay	(0~3600)s	1	Time from mains abnormal or remote start signal is active to start genset.
2	Stop Delay	(0~3600)s	1	Time from mains normal or remote start signal is deactivated to genset stop.
3	Preheat Delay	(0~3600)s	0	Time of pre-powering heat plug before starter is powered up.
4	Cranking Time	(3~60)s	8	Time of starter power up
5	Crank Rest Time	(3~60)s	10	The waiting time before second power up when engine start fail.
6	Safety On Delay	(0~3600)s	10	Alarms for low oil pressure, high temperature, under speed, under frequency/voltage, charge fail are inactive.
7	Start Idle Time	(0~3600)s	0	Idle running time of genset when starting.
8	Warming Up Time	(0~3600)s	10	Warming time between genset switch on and high speed running.
9	Cooling Time	(0~3600)s	10	Radiating time before genset stop, after it unloads.
10	Stop Idle Time	(0~3600)s	0	Idle running time when genset stop.
11	ETS Solenoid Hold	(0~3600)s	20	Stop electromagnet's power on time when genset is stopping.
12	Fail to Stop Delay	(0~3600)s	0	Time between ending of genset idle delay and stopped when "ETS time" is set as 0; Time between ending of ETS hold delay and stopped when "ETS Hold output time" is not 0.
13	After Stop Time	(0~3600)s	0	Time between genset stopped and standby
Engine Setting				
1	Engine Type	Fixed value: 0	0	Default: Conventional genset
2	Flywheel Teeth	(10~300)	118	Tooth number of the engine, for judging of starter separation conditions and inspecting of engine speed. See the installation instructions.

No.	Items	Parameters	Defaults	Description
3	Rated Speed	(0~6000)r/min	1500	Offer standard to judge over/under/loading speed.
4	Speed on Load	(0~100)%	90%	Setting value is percentage of rated speed. Controller detects when it is ready to load. It won't switch on when speed is under loading speed.
5	Loss of Speed Signal	(0~3600)s	5	Time from detecting speed is 0 to confirm the action.
6	Loss of Speed Action	(0~1)	0	0:Warn; 1:Shutdown
7	Over Speed Shutdown	(0~200)%	114%	Setting value is percentage of rated speed and delay value also can be set.
8	Under Speed Shutdown	(0~200)%	80%	Setting value is percentage of rated speed and delay value also can be set.
9	Over Speed Warn	(0~200)%	110%	Setting value is percentage of rated speed. Delay value and return value also can be set.
10	Under Speed Warn	(0~200)%	86%	Setting value is percentage of rated speed. Delay value and return value also can be set.
11	Battery Rated Voltage	(0~60.0)V	24.0	Standard for detecting over/under voltage of battery.
12	Battery Over Volts	(0~200)%	120%	Setting value is percentage of rated voltage of battery. Delay value & return value also can be set.
13	Battery Under Volts	(0~200)%	85%	Setting value is percentage of rated voltage of battery. Delay value & return value also can be set.
14	Charge Alt Fail	(0~60.0)V	8.0	In normal running, when charger D+(WL) voltage under this value, charge failure alarms.
15	Start Attempts	(1~10) times	3	Max. Crank times of crank attempts. When reach this number, controller will send start failure signal.
16	Crank Disconnect	(0~6)	2	See form 5 There are 3 conditions of disconnecting starter with engine. Each condition can be used alone and simultaneously to separating the

No.	Items	Parameters	Defaults	Description
				start motor and genset as soon as possible.
17	Disconnect Generator Freq	(0~200)%	24%	When generator frequency higher than the set value, starter will be disconnected. See the installation instruction.
18	Disconnect Engine Speed	(0~200)%	24%	Setting value is percentage of rated speed. When engine speed higher than the set value, starter will be disconnected. See the installation instruction.
19	Disconnect Oil Pressure	(0~1000)kPa	200	When generator oil pressure higher than the set value, starter will be disconnected. See the installation instruction.
Generator Setting				
1	AC System	(0~3)	0	0: 3P4W; 1: 3P3W; 2: 2P3W; 3: 1P2W.
2	Poles	(2~32)	4	Numbers of generator pole, used for calculating starter rotate speed when without speed sensor.
3	Rated Voltage	(30~30000)V	230	To offer standards for detecting of generator' over/under voltage and loading voltage. (It is primary voltage when using voltage transformer).
4	Loading Voltage	(0~200)%	85%	Setting value is percentage of generator rated voltage. Detect when controller ready to loading. If generator voltage under load voltage, won't enter into normally running.
5	Rated Frequency	(10.0~600.0) Hz	50.0	To offer standards for detecting of over/under/load frequency.
6	Loading Frequency	(0~200)%	85%	Setting value is percentage of generator rated frequency. When generator frequency under load frequency, it won't enter into normal running.
7	Volt. Trans.(PT)	(0~1)	0	0: Disable; 1:Enable
8	Over Volt. Shutdown	(0~200)%	120%	Setting value is percentage of generator rated volt. Delay value can



No.	Items	Parameters	Defaults	Description
9	Under Volt. Shutdown	(0~200)%	80%	be set.
10	Over Freq. Shutdown	(0~200)%	114%	Setting value is percentage of generator rated freq. Delay value also can be set.
11	Under Freq. Shutdown	(0~200)%	80%	Setting value is percentage of generator rated frequency. Delay value can be set.
12	Over Volt. Warn	(0~1000)%	110%	Setting value is percentage of generator rated voltage. Delay value and return value also can be set.
13	Under Volt. Warn	(0~1000)%	84%	Setting value is percentage of generator rated volt. Delay value and return value also can be set.
14	Over Freq. Warn	(0~1000)%	110%	Setting value is percentage of generator rated freq. Delay value and return value also can be set.
15	Under Freq. Warn	(0~1000)%	84%	Setting value is percentage of generator rated freq. Delay value and return value also can be set.
16	Loss of Phase	(0~1)	1	0: Disable 1: Enable
17	Phase Sequence Wrong	(0~1)	1	
Load Setting				
1	Current Trans.	(5~6000)/5	500	The ratio of external CT
2	Full Current Rating	(5~6000)A	500	Generator's rated current, standard of load current.
3	Full kW rating	(0~6000)kW	276	Generator's rated power, standard of load power.
4	Over Current	(0~200)%	120%	Setting value is percentage of generator full load current. Delay value also can be set.
5	Over Power	(0~1)	0	0: Disable 1: Enable
6	Reverse Power	(0~1)	0	0: Disable 1: Enable
Switch Setting				
1	Transfer Time	(0~7200)s	5	Interval time from mains switch off to

No.	Items	Parameters	Defaults	Description
				generator switch on; or from generator switch off to mains switch on.
2	Close Time	(0~20.0)s	5.0	Pulse width of mains/generator switch on. When it is 0, means output constantly.
3	Open Time	(0~20.0)s	3.0	Pulse width of mains/generator switch off.
4	Check Time	(0~20.0)s	5.0	Time of detecting switch auxiliary contacts after transferred.
5	Warn Enable	(0~1)	0	0: Disable 1: Enable
6	Check Enable	(0~1)	0	0: Disable 1: Enable
7	Enable Immediate Mains Dropout	(0~1)	1	0: Disable 1: Enable
Module Setting				
1	Power Mode	(0~2)	0	0: Stop mode 1: Manual mode 2: Auto mode
2	Module Address	(1~254)	1	Controller's address during remote sensing.
3	Stop Bits	(0~1)	0	0: 2 stop bits; 1: 1 stop bit
4	Language	(0~2)	0	0: Simplified Chinese 1: English 2: Others
5	Password	(0~65535)	00318	For entering advanced parameters setting.
Scheduling And Maintenance Setting				
1	Scheduled Run	(0~1)	0	0: Disable; 1: Enable
2	Scheduled Not Run	(0~1)	0	0: Disable; 1: Enable
3	Maintenance	(0~1)	0	0: Disable; 1: Enable
Analog Sensors Setting				
Temperature Sensor				
1	Curve Type	(0~15)	7	SGX See form 4.
2	Open Circuit Action	(0~2)	0	0: Warn; 1: Shutdown; 2: No action
3	High Temp. Shutdown	(0~300)°C	98	Shutdown when sensor temperature higher than this value. Detecting only after safety delay is over. The delay value also can be set.



No.	Items	Parameters	Defaults	Description
4	High Temp. Warn	(0~300) °C	95	Warn when sensor temperature higher than this value. Detecting only after safety delay is over. The delay value and return value also can be set.
5	Low Temp. Warn	(0~1)	0	0: Disable; 1: Enable
Oil Pressure Sensor				
1	Curve Type	(0~15)	7	SGX See form 4.
2	Open Circuit Action	(0~2)	0	0: Warn 1: Shutdown 2: No action
3	Low OP Shutdown	(0~1000)kPa	103	Shutdown when oil pressure lower than this value. Detecting only after safety delay is over. The delay value also can be set.
4	Low OP Warn	(0~1000)kPa	124	Warn when oil pressure higher than this value. Detecting only after safety delay is over. The delay value and return value also can be set.
Liquid Level Sensor				
1	Curve Type	(0~15)	4	SGH See form 4
2	Open Circuit Action	(0~2)	0	0:Warn; 1:Shutdown; 2:No action
3	Low Level Warn	(0~300)%	10	Warn when level lower than this value. It is detecting all the time. The delay value and return value also can be set.
Flexible Sensor 1				
1	Flexible Sensor 1 Setting	(0~1)	0	0: Disable 1: Enable; (can be set as temperature/pressure/liquid level sensor).
Flexible Sensor 2				
1	Flexible Sensor 2 Setting	(0~1)	0	0: Disable; 1: Enable; (can be set as temperature/pressure/liquid level sensor).
Flexible Input Ports				
Flexible Input Port 1				
1	Contents Setting	(0~50)	28	Remote start (on load). See form 3
2	Active Type	(0~1)	0	0: Closed to active 1: Open to active



No.	Items	Parameters	Defaults	Description
Flexible Input Port 2				
1	Contents Setting	(0~50)	26	High temperature shutdown See form 3
2	Active Type	(0~1)	0	0: Closed to active 1: Open to active
Flexible Input Port 3				
1	Contents Setting	(0~50)	27	Low oil pressure shutdown See form 3
2	Active Type	(0~1)	0	0: Closed to active 1: Open to active
Flexible Input Port 4				
1	Contents Setting	(0~50)	0	User defined. See form 3
2	Active Type	(0~1)	0	0: Closed to active 1: Open to active
3	Arming	(0~3)	2	0: From safety on 1: From starting 2: Always 3:Never
4	Active Actions	(0~4)	0	0: Warn; 1: Shutdown; 2:Trip and stop 3:Trip 4: Indication
5	Active Delay	(0~20.0)s	2.0	Time from detecting active to confirm
6	Description			User defined.
Flexible Input Port 5				
1	Contents Setting	(0~50)	0	User defined. See form 3
2	Active Type	(0~1)	0	0: Closed to active 1: Open to active
3	Arming	(0~3)	2	0: From safety on 1: From starting 2: Always 3:Never
4	Active Actions	(0~4)	1	0: Warn; 1: Shutdown; 2:Trip and stop 3:Trip 4: Indication
5	Active Delay	(0~20.0)s	2.0	Time from detecting active to confirm
6	Description			User defined.
Flexible Input Port 6				
1	Contents Setting	(0~50)	0	User defined .See form 3
2	Active Type	(0~1)	0	0: Closed to active 1: Open to active
3	Arming	(0~3)	2	0: From safety on 1: From starting 2: Always 3:Never
4	Active Actions	(0~4)	2	0: Warn; 1: Shutdown; 2:Trip and stop 3:Trip 4: Indication

No.	Items	Parameters	Defaults	Description
5	Active Delay	(0~20.0)s	2.0	Time from detecting active to confirm
6	Description			User defined.
Flexible Output Ports				
Flexible Output Port 1				
1	Contents Setting	(0~239)	1	User defined period output (default output is in preheating) See Form 2
2	Active Type	(0~1)	0	0:Normally open; 1:Normally close
Flexible Output Port 2				
1	Contents Setting	(0~239)	48	Common alarm. See form 2
2	Active Type	(0~1)	0	0:Normally open; 1:Normally close
Flexible Output Port 3				
1	Contents Setting	(0~239)	38	ETS solenoid hold. See form 2
2	Active Type	(0~1)	0	0:Normally open; 1:Normally close
Flexible Output Port 4				
1	Contents Setting	(0~239)	35	Idle speed control. See form 2
2	Active Type	(0~1)	0	0:Normally open; 1:Normally close
Flexible Output Port 5				
1	Contents Setting	(0~239)	29	Generator closed output. See form 2
2	Active Type	(0~1)	0	0:Normally open; 1:Normally close
Flexible Output Port 6				
1	Contents Setting	(0~239)	31	Mains closed output. See form 2
2	Active Type	(0~1)	0	0:Normally open; 1:Normally close

 **Note:** Overcurrent setting details about definite time delay and inverse definite minimum time are as follows:

Definite Time: Overcurrent delay is definite time delay. Different overcurrent value has corresponding delay.

Inverse Definite Minimum Time(IDMT): Overcurrent delay decrease with the increase of overcurrent. Different overcurrent value has corresponding delay.

IDMT formula:

$$T = t / ((IA/IT)-1)^2$$

T: Overcurrent delay (second)

t: Timing multiplier ratio

IA: Current max. load current (L1/L2/L3)

IT: Overcurrent setting value

Example:

t = 36

IA = 550A

IT = 500A

Conclusion: T = 3600s(1hour)

SmartGen

7.2 ENABLE DEFINITION OF PROGRAMMABLE OUTPUT PORTS

(Form 2)

No.	Type	Description
0	Not Used	
1	Custom Period 1	Details of function description please see the following.
2	Custom Period 2	
3	Custom Period 3	
4	Custom Period 4	
5	Custom Period 5	
6	Custom Period 6	
7	Custom Combined 1	
8	Custom Combined 2	
9	Custom Combined 3	
10	Custom Combined 4	
11	Custom Combined 5	
12	Custom Combined 6	
13	Reserved	
14	Reserved	
15	Reserved	
16	Reserved	
17	Air Flap	Action when over speed shutdown and emergence stop. It also can close the air inflow to stop the engine as soon as possible.
18	Audible Alarm	Action when warning, shutdown, trips. Can be connected annunciator externally. When "alarm mute" configurable input port is active, it can remove the alarm.
19	Louver Control	Action in genset starting and disconnect when genset stopped completely.
20	Fuel Pump Control	It is controlled by fuel pump of level sensor's limited threshold.
21	Heater Control	It is controlled by heating of temperature

		sensor's setting bound.
22	Cooler Control	It is controlled by cooler of temperature sensor's setting bound.
23	Oil Pre-supply	Actions in period of cranking to safety run.
24	Excite Generator	Output in start period. If there is no generator frequency during hi-speed running, output for 2 seconds again.
25	Pre-Lubricate	Actions in period of pre-heating to safety run.
26	Remote PC Output	This port is controlled by communication (PC).
27	Reserved	
28	Reserved	
29	Close Generator	Control generator to take load.
30	Open Breaker	Control generator to off load.
31	Close Mains	Control mains to take load.
32	Reserved	
33	Crank Relay	
34	Fuel Relay	Action when genset is starting and disconnect when stop is completed.
35	Idle Control	Used for engine which has idles. Close before starting and open in warming up delay; Close during stopping idle mode and open when stop is completed.
36	Raise Speed	Action in warming up delay.
37	Drop Speed	Action between the period from "stop idle" to "failed to stop".
38	ETS Control	Used for engines with ETS electromagnet. Close when stop idle is over and open when pre-set "ETS delay" is over.
39	Pulse Drop speed	Active 0.1s when controller enter into stop idle, used for control part of ECU dropping to idle speed (temporary reserved).
40	Reserved	
41	Reserved	

42	Pulse raise speed	Active 0.1s when controller enter into warming up delay; used for control part of ECU raising to normal speed (temporary reserved).
43	Crank Success	Close when detects a successful start signal.
44	Generator OK	Action when generator are normal.
45	Generator Available	Action in period of generator ok to hi-speed cooling.
46	Mains OK	Action when mains normal.
47	Reserved	
48	Common Alarm	Action when genset common warning, common shutdown, common trips alarm.
49	Common Trip and Stop	Action when common trip and stop alarm.
50	Common Shutdown	Action when common shutdown alarm.
51	Common Trip Alarm	Action when common trips alarm.
52	Common Warn Alarm	Action when common warning alarm.
53	Reserved	
54	Battery High Volts	Action when battery's over voltage warning alarm.
55	Battery Low Volts	Action when battery's low voltage warning alarm.
56	Charge Alt Fail	Action when charge failure warning alarms.
57	Reserved	
58	Reserved	
59	Reserved	
60	Reserved	
61	Reserved	
62	Reserved	
63	Reserved	
64	Reserved	
65	Reserved	
66	Reserved	
67	Reserved	
68	Reserved	

69	Aux Input 1 Active	Action when input port 1 is active
70	Aux Input 2 Active	Action when input port 2 is active
71	Aux Input 3 Active	Action when input port 3 is active
72	Aux Input 4 Active	Action when input port 4 is active
73	Aux Input 5 Active	Action when input port 5 is active
74	Aux Input 6 Active	Action when input port 6 is active
75~98	Reserved	
99	Emergency Stop	Action when emergency stop alarm.
100	Failed To Start	Action when failed start alarm.
101	Failed To Stop	Action when failed stop alarm.
102	Under Speed Warn	Action when under speed alarm.
103	Under Speed Shutdown	Action when under speed shuts down.
104	Over Speed Warn	Action when over speed warn.
105	Over Speed Shutdown	Action when over speed shutdown alarm.
106	Loss of Speed Signal Shutdown	Action when loss of speed signal shutdown alarm.
107	Reserved	
108	Reserved	
109	Gen over frequency Warn	Action when generator over frequency warning.
110	Gen over frequency Shut	Action when generator over frequency shutdown alarm.
111	Gen Over Volt Warn	Action when generator over voltage warning.
112	Gen Over Volt Shut	Action when generator over voltage shutdown.
113	Gen Under Freq. Warn	Action when generator low frequency warning.
114	Gen Under Freq. Shut	Action when generator low frequency shutdown.
115	Gen Under Volt. Warn	Action when generator low voltage warning.
116	Gen Under Volt. Shut	Action when generator low voltage shutdown.
117	Gen Loss of Phase	Action when generator loss phase.
118	Gen Reverse Phase	Action when generator reverse phase.
119	Reserved	
120	Over Power	Action when controller detects generator have

		over power.
121	Reserved	
122	Reverse Power	Action when controller detects generator have reverse power.
123	Over Current	Action when over current.
124	Reserved	
125	Mains Inactive	
126	Mains Over Freq	
127	Mains Over Volt	
128	Mains Under Freq	
129	Mains Under Volt	
130	Mains Reverse Phase	
131	Mains Loss of Phase	
132~138	Reserved	
139	High Temp Warn	Action when hi-temperature warning.
140	Low Temp Warn	Action when low temperature warning.
141	High Temp Shutdown	Action when hi-temperature Shutdown alarm.
142	Reserved	
143	Low OP Warn	Action when low oil pressure warning.
144	Low OP Shutdown	Action when low oil pressure shutdown.
145	OP Sensor Open	Action when oil pressure sensor is open circuit.
146	Reserved	
147	Low Level Warn	Action when controller has low oil level alarm.
148	Reserved	
149	Reserved	
150	Config1 High Warn	
151	Config1 Low Warn	
152	Config1 High Shut	
153	Config1 Low Shut	
154	Config2 High Warn	
155	Config2 Low Warn	
156	Config2 High Shut	

157	Config2 Low Shut	
158~229	Reserved	
230	Stop Mode	Action in stop mode.
231	Manual Mode	Action in Manual mode.
232	Test Mode	Action in Test mode. (HGM8110A without)
233	Auto Mode	Action in Auto mode.
234	Generator On Load	
235	Mains On Load	
236	Reserved	
237	Reserved	
238	Reserved	
239	Reserved	

7.2.1 Custom Period Output

Defined Period output is composed by 2 parts, period output S1 and condition output S2.



While S1 and S2 are **TRUE** synchronously, OUTPUT;

While S1 or S2 is **FALSE**, NOT OUTPUT.

Period output S1, can set generator's one or more period output freely, can set the delayed time and output time after enter into period.

Condition output S2; can set as any conditions in output ports.

NOTE: when delay time and output time both are 0 in period output S1, it is **TRUE** in this period.

Example,

Output period: start

Delay output time: 2s

Output time: 3s

Condition output contents: output port 1 is active

Close when condition output active/inactive: close when active (disconnect when inactive);

Output port 1 active, after enter "starts time" and delay 2s, this defined period output is outputting, after 3s, stop outputting;

Output port 1 inactive, defined output period is not outputting.

7.2.2 Custom Combined Output

Defined combination output is composed by 3 parts, condition output S1 or S2 and condition output S3.

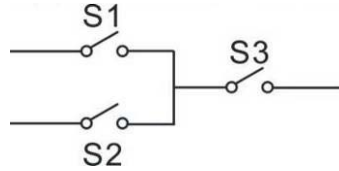

S1 or S2 is **TRUE**, while S3 is **TRUE**, Defined combination output is outputting;

S1 and S2 are **FALSE**, or S3 is **FALSE**, Defined combination output is not outputting.

▲NOTE: S1, S2, S3 can be set as any contents except for “defined combination output” in the output setting.

▲NOTE: 3 parts of defined combination output (S1, S2, S3) couldn't include or recursively include themselves.

Example,

Contents of probably condition output S1: output port 1 is active;

Close when probably condition output S1 is active /inactive: close when active (disconnect when inactive);

Contents of probably condition output S2, output port 2 is active;

Close when probably condition output S2 is active /inactive: close when active (disconnect when inactive);

Contents of probably condition output S3: output port 3 is active;



Close when probably condition output S3 is active /inactive: close when active (disconnect when inactive);





When input port 1 active or input port 2 active, if input port 3 is active, Defined combination output is outputting; If input port 3 inactive, Defined combination output is not outputting;

When input port 1 inactive and input port 2 inactive, whatever input port 3 is active or not, Defined combination output is not outputting.

7.3 DEFINED CONTENTS OF CONFIGURABLE INPUT PORTS (All active when connect to grand (B-))

Form 3

No.	Type	Description
0	Users Configured	<p>Including following functions, Indication: indicate only, not warning or shutdown. Warning: warn only, not shutdown. Shutdown: alarm and shutdown immediately Trip and stop: alarm, generator unloads and shutdown after hi-speed cooling Trip: alarm, generator unloads but not shutdown. Never: input inactive. Always: input is active all the time. From crank: detecting as soon as start. From safety on: detecting after safety on run delay.</p>
1	Reserved	
2	Alarm Mute	Can prohibit "Audible Alarm" output when input is active.
3	Reset Alarm	Can reset shutdown alarm and trip alarm when input is active.
4	60Hz Active	Use for CANBUS engine and it is 60Hz when input is active.
5	Lamp Test	All LED indicators are illuminating when input is active.
6	Panel Lock	All buttons in panel is inactive except  and there is  in the left of first row in LCD when input is active.
7	Reserved	
8	Idle Control Mode	Under voltage/frequency/speed protection is inactive.
9	Inhibit Auto Stop	In Auto mode, during generator normal running, when input is active, inhibit generator shutdown automatically.
10	Inhibit Auto Start	In Auto mode, inhibit generator start automatically when input is active.
11	Inhibit Scheduled	In Auto mode, inhibit scheduled run genset when input is active.
12	Reserved	

13	Aux Gen Closed	Connect generator loading switch's Aux. Point.
14	Inhibit Gen Load	Prohibit genset switch on when input is active.
15	Aux Mains Closed	Connect mains loading switch's Aux. Point.
16	Inhibit Mains Load	Prohibit mains switch on when input is active.
17	Auto Mode Lock	When input is active, controller enters into Auto mode; all the keys except   are inactive, and  will show in the first line of LCD display.
18	Auto Mode Invalid	When input is active, controller won't work under Auto mode.  key and simulate auto key input does not work.
19	Reserved	
20	Reserved	
21	Inhibit Alarm Stop	All shutdown alarms are prohibited except emergence stop.(Means battle mode or override mode)
22	Aux Instrument Mode	All outputs are prohibited in this mode.
23	Reserved	
24	Reset Maintenance	Controller will set maintenance time and date as default when input is active.
25	Reserved	
26	Aux. High Temp	Connected sensor digital input.
27	Aux. Low OP	Connected sensor digital input.
28	Remote Start (On Load)	In Auto mode, when input active, genset can be started automatically and take load after genset normal running; when input inactive, genset will stop automatically.
29	Remote Start (Off Load)	In Auto mode, when input is active, genset can be started automatically and NOT take load after genset normal running; when input is inactive, genset will stop automatically.
30	Aux. Manual Start	In Manual mode, when input active, genset will start automatically; when input inactive, genset will stop automatically
31	Reserved	
32	Reserved	
33	Simulate Stop key	An external button can be connected and pressed as simulate panel.
34	Simulate Manual key	
35	Simulate Manual Test key	
36	Simulate Auto key	

37	Simulate Start key	
38	Reserved	
39	Reserved	
40	Reserved	
41	Reserved	
42	Reserved	
43	Reserved	
44	Reserved	
45	Aux Mains OK	In Auto mode, mains are normal when input is active (HGM8120A).
46	Aux Mains Fail	In Auto mode, mains are abnormal when input is active (HGM8120A).
47	Alternative Config1	Users can set different parameters to make it easy to select current configuration via input port.
48	Alternative Config2	
49	Alternative Config3	
50	Reserved	

SmartGen

7.4 SELECTION OF SENSORS

Form4

No.		Description	Remark
1	Temperature Sensor	0 Not used 1 Custom Res Curve 2 Custom 4-20mA curve 3 VDO 4 CURTIS 5 VOLVO-EC 6 DATCON 7 SGX 8 SGD 9 SGH 10 PT100 11~15 Reserved	Defined resistance's range is 0~6KΩ, default is SGX sensor.
2	Pressure Sensor	0 Not used 1 Custom Res Curve 2 Custom 4-20mA curve 3 VDO 10Bar 4 CURTIS 5 VOLVO-EC 6 DATCON 10Bar 7 SGX 8 SGD 9 SGH 10 VDO 5bar 11~15 Reserved	Defined resistance's range is 0~6KΩ, default is SGX sensor.
3	Oil Level Sensor	0 Not used 1 Custom Res Curve 2 Custom 4-20mA curve 3 SGD 4 SGH 5~15 Reserved	Defined resistance's range is 0~6KΩ, default is SGH sensor.

NOTE: User should make special declare when order controller if your genset equip with sensor of 4~20mA.



7.5 CONDITIONS OF CRANK DISCONNECT SELECTION

No.	Setting description
0	Gen frequency
1	Speed sensor
2	Speed sensor + Gen frequency
3	Oil pressure
4	Oil pressure + Gen frequency
5	Oil pressure + Speed sensor
6	Oil pressure + Speed sensor + Gen frequency

NOTE:

1. There are 3 conditions to make starter disconnected with engine, that is, speed sensor, generator frequency and engine oil pressure. They all can be used separately. We recommend that engine oil pressure should be using with speed sensor and generator frequency together, in order to make the starter motor is separated with engine immediately and can check crank disconnect exactly.
2. Speed sensor is the magnetic equipment which be installed in starter for detecting flywheel teeth.
3. When set as speed sensor, must ensure that the number of flywheel teeth is as same as setting, otherwise, “over speed shutdown” or “under speed shutdown” may be caused.
4. If genset without speed sensor, please don't select corresponding items, otherwise, “start fail” or “loss speed signal” maybe caused.
5. If genset without oil pressure sensor, please don't select corresponding items.
6. If not select generator in crank disconnect setting, controller will not collect and display the relative power quantity (can be used in water pump set); if not select speed sensor in crank disconnect setting, the rotating speed displayed in controller is calculated by generator frequency and number of poles.

8 PARAMETER EDITING



- 1) **Advanced Parameters Setting:** After controller start, press  and  to advanced parameter password confirmation interface (picture on the right). Press “+” and “-” to increase or decrease values and input the corresponding password; press “√” key to right move the bit, in fourth bit press “√” key to check password. If password is correct, enter into advanced parameter setting interface, otherwise, exit directly. (Factory default password is **00318** and users can modify it.)

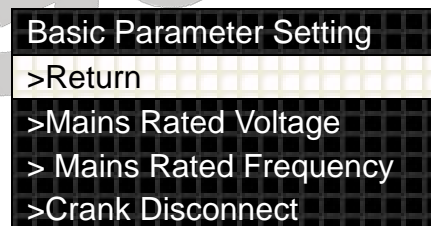

Press “+” key and “-” key to scroll screen; select parameter you want to configure and press “√” key (the parameter will highlight with black), press “+” key or “-” key to change parameter value, press “√” key to move the bit, in fourth bit press “√” key to confirm setting.

- 2) **Basic Parameter Setting:** After controller start, press  for more than 3s to enter into Basic Parameter Setting interface; The frequently-used parameters can be set via both Basic Parameter Setting and Advanced Parameter Setting, however, set the frequently-used parameters via Basic Parameter Setting is recommended as there are lots of parameters in Advanced Parameter Setting and inconvenience. The picture on the right is “Basic Parameter Setting” interface, the parameter which highlight with black is the current setting one.



- 3) **Date and Time Setting:** After controller start, press  and  to the Date and Time Setting interface (picture on the right). The digital which highlight with black is currently adaptable for user by pressing “+” key and “-” key to increase and decrease the value.

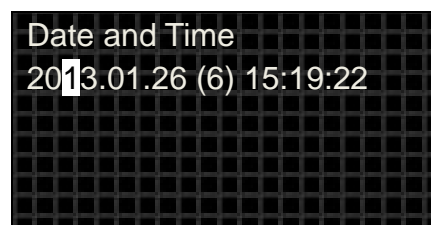

Press “√” key to confirm setting and the bit will right move automatically. Number “6” in the parenthesis is the day of the week. It is set by the microprocessor based on current date, so the user does not need to modify it.

⚠ CAUTION: Please change the controller parameters when generator is in standby

mode only (e. g. Crank disconnect conditions selection, configurable input, configurable output, various delay), otherwise, shutdown and other abnormal conditions may happen.

▲NOTE: Maximum set value must over minimum set value in case that the condition of too high as well as too low will happen.

▲NOTE: When setting the warning alarm, please set the correct return value; otherwise, maybe there is abnormal alarm. When setting the maximum value, the return value must less than set value; When setting the minimum value, the return value must over set value.

▲NOTE: Please set the generator frequency value as low as possible when cranking, in order to make the starter be separated quickly as soon as crank disconnect.

▲NOTE: Configurable input could not be set as same items; otherwise, there are abnormal functions. However, the configurable output can be set as same items.

▲NOTE: HGM8110A controller has no items about mains. Pressing and holding  for a long time can exit parameter setting menu directly and set the controller into standby mode.

9 SENSORS SETTING

1. When reselect sensors, the sensor curve will be transferred into the standard value. For example, if temperature sensor is SGX (120°C resistor type), its sensor curve is SGX (120°C resistor type); if select the SGD (120°C resistor type), the temperature sensor curve is SGD curve.
2. When there is difference between standard sensor curves and using sensor, user can adjust it in “curve type”.
3. When input the sensor curve, X value (resistor) must be input from small to large, otherwise, mistake occurs.
4. If select sensor type as “None”, sensor curve is not working.
5. If corresponding sensor has alarm switch only, user must set this sensor as “None”, otherwise, maybe there is shutdown or warning.
6. The headmost or backmost values in the vertical coordinates can be set as same as below,

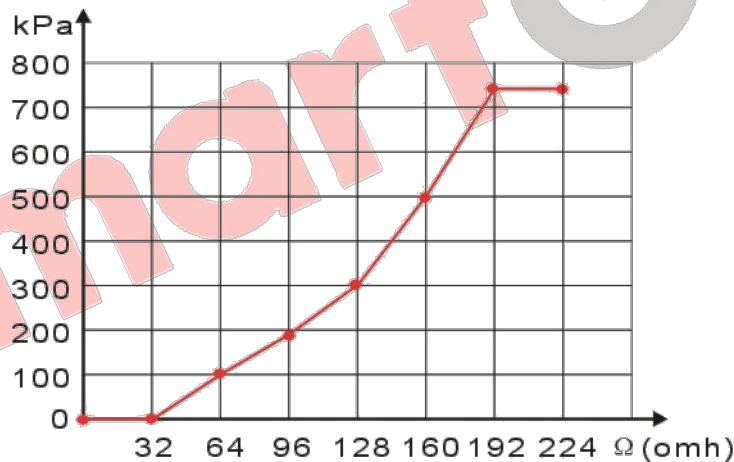

Normal Pressure Unit Conversion Form

	pa	kgf/cm ²	bar	psi
1Pa	1	1.02x10 ⁻⁵	1x10 ⁻⁵	1.45x10 ⁻⁴
1kgf/cm ²	9.8x10 ⁴	1	0.98	14.2
1bar	1x10 ⁵	1.02	1	14.5
1psi	6.89x10 ³	7.03x10 ⁻²	6.89x10 ⁻²	1

10 COMMISSIONING

Please make the under procedures checking before commissioning,

1. Ensure all the connections are correct and wires diameter is suitable.
2. Ensure that the controller DC power has fuse, controller's positive and negative connected to start battery are correct.
3. Emergence stop must be connected with positive of start battery via scram button's normal close point and fuse.
4. Take proper action to prevent engine to crank disconnect (e. g. Remove the connection wire of fuel valve). If checking is OK, make the start battery power on; choose manual mode and controller will executive routine.
5. Set controller under manual mode, press "start" button, genset will start. After the cranking times as setting, controller will send signal of Start Fail; then press "stop" to reset controller.
6. Recover the action of stop engine start (e. g. Connect wire of fuel valve), press start button again, genset will start. If everything goes well, genset will normal run after idle running (if idle run be set). During this time, please watch for engine's running situations and AC generator's voltage and frequency. If abnormal, stop genset running and check all wires connection according to this manual.
7. Select the **AUTO** mode from controller's panel, connect mains signal. After the mains normal delay, controller will transfer ATS (if fitted) into mains load. After cooling time, controller will stop genset and make it into "at rest" mode until there is abnormal of mains.
8. When mains is abnormal again, genset will be started automatically and into normal running, then controller send signal to making generator switch on, and control the ATS as generator load. If not like this, please check ATS' wires connection of control part according to this manual.
9. If there is any other question, please contact Smartgen's service.

11 TYPICAL WIRING DIAGRAMS

HGM8110A Typical wiring diagram

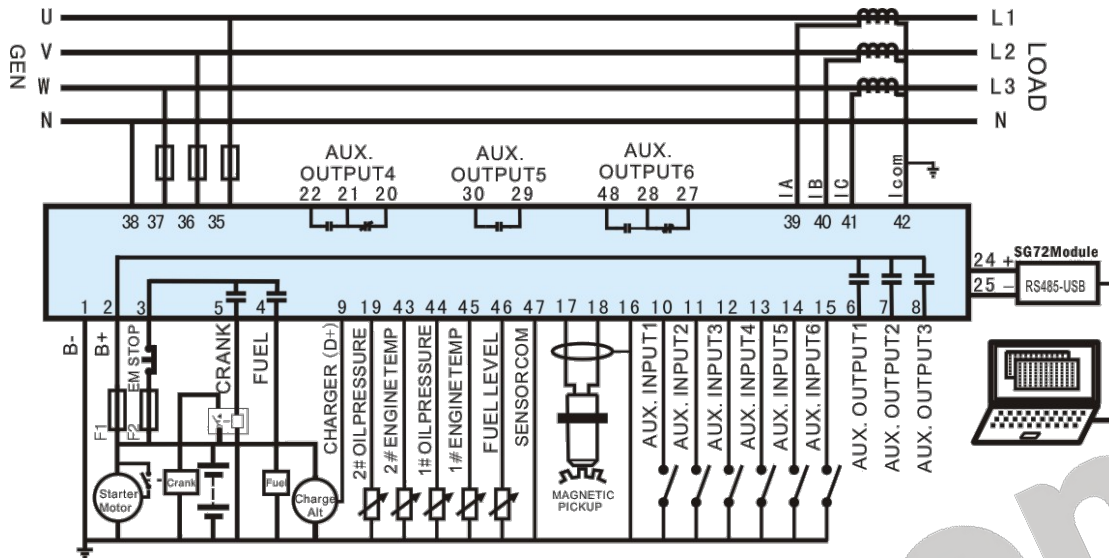

HGM8120A Typical wiring diagram

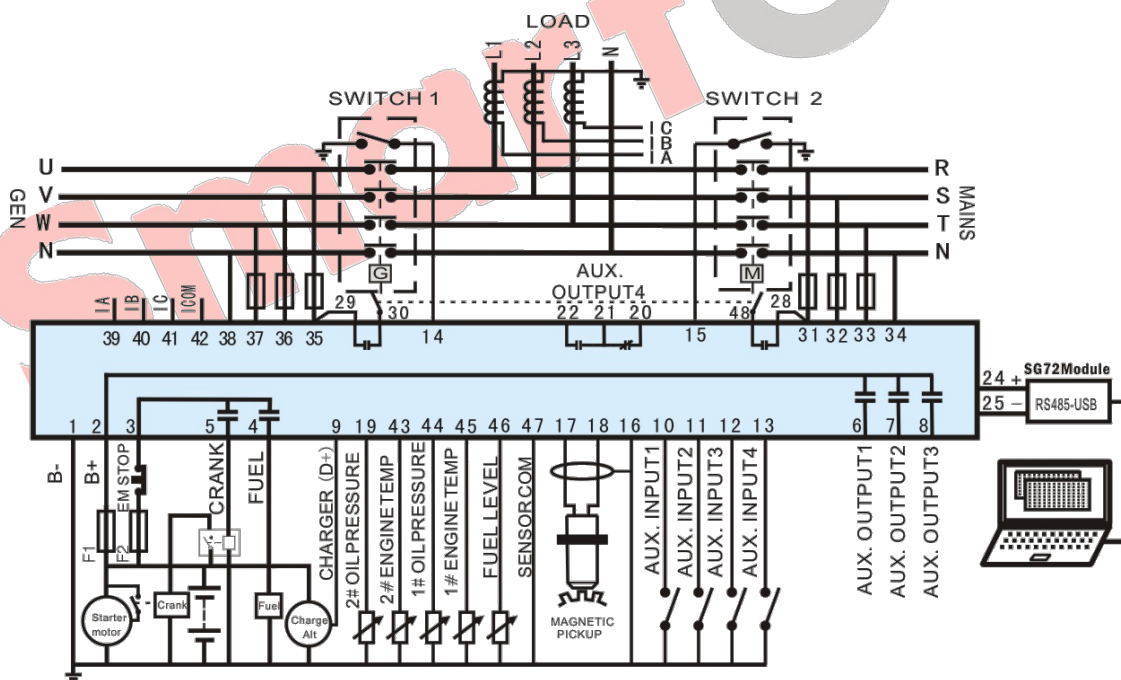

Note: If the engine starting battery voltage is 24V, starting output, fuel output and stop output (according to user's configuration) should not be less than 2 ohms for battery cathode resistance, if less than 2 ohms, please expand relays with more than 30A current in corresponding output. if the engine starting battery voltage is 12V, starting output, fuel output and stop output (according to user's configuration) should not be less than 1 ohms

for battery cathode resistance; if less than 1 ohm, please expand relays with more than 30A current in corresponding output.

3 Phase 3 Wire (take HGM8120A for example)

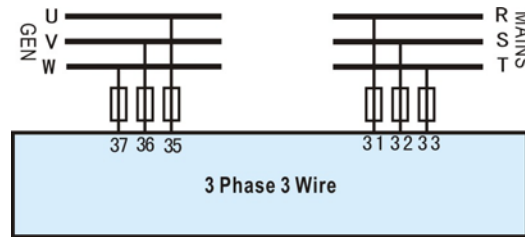

Single Phase 2 Wire (take HGM8120A for example)

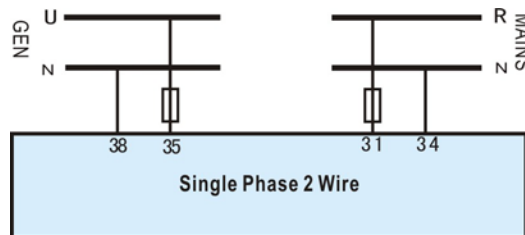

2 Phase 3 Wire (take HGM8120A for example)

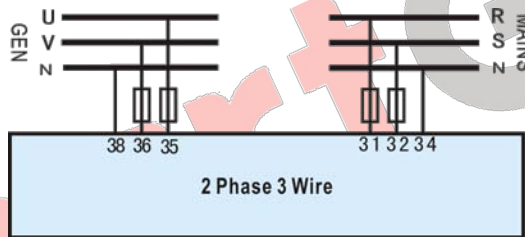

12 INSTALLATION

The installation dimension of **HGM8110A** is just the same with **HGM8120A**.

Controller is panel built-in design; it is fixed by clips when installed. The controller's overall dimensions and cutout dimensions for panel, please refers to as following,

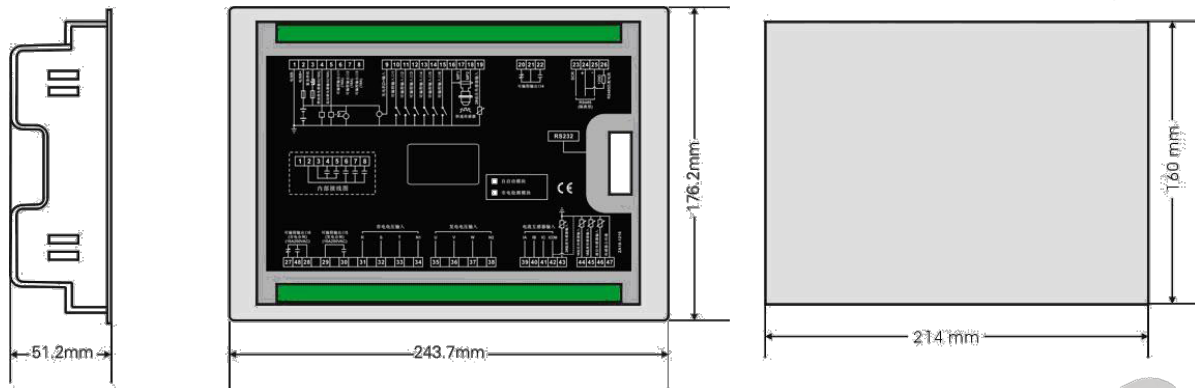

12.1 BATTERY VOLTAGE INPUT

NOTE: HGM8110A/8120A controller can suit for widely range of battery voltage DC(8~35)V. Negative of battery must be connected with the engine shell. The diameter of wire which from power supply to battery must be over 2.5mm^2 . If floating charge configured, please firstly connect output wires of charger to battery's positive and negative directly, then, connect wires from battery's positive and negative to controller's positive and negative input ports in order to prevent charge disturbing the controller's normal working.

12.2 SPEED SENSOR INPUT

NOTE: Speed sensor is the magnetic equipment which be installed in starter and for detecting flywheel teeth. Its connection wires to controller should apply for 2 cores shielding line. The shielding layer should connect to No. 16 terminal in controller while another side is hanging in air. The else two signal wires are connected to No.17 and No.18 terminals in controller. The output voltage of speed sensor should be within AC(1~24)V (effective value) during the full speed. AC12V is recommended (in rated speed). When install the speed sensor, let the sensor is spun to contacting flywheel first, then, port out 1/3 lap, and lock the nuts of sensor at last.

12.3 OUTPUT AND EXPAND RELAYS

CAUTION: All outputs of controller are relay contact output type. If need to expand the relays, please add freewheel diode to both ends of expand relay's coils (when coils of relay has DC current) or, add resistance-capacitance return circuit (when coils of relay has AC current), in order to prevent disturbance to controller or others equipment.

12.4 AC INPUT

Current input of HGM8110A/8120A controller must be connected to outside current transformer. And the current transformer's secondary side current must be 5A. At the same time, the phases of current transformer and input voltage must correct. Otherwise, the current of collecting and active power maybe not correct.

 **NOTE:** ICOM port must be connected to negative pole of battery.

 **WARNING!** When there is load current, transformer's secondary side prohibit open circuit.

12.5 WITHSTAND VOLTAGE TEST

 **CAUTION!** When controller had been installed in control panel, if need the high voltage test, please disconnect controller's all terminal connections, in order to prevent high voltage into controller and damage it.

SmartGen

13 FACTORY DEFAULT VALUES

Here are the common faults and troubleshooting. If there is any other problem, please feel free to contact Smartgen's service.

Symptoms	Possible Solutions
Controller no response with power.	Check starting batteries; Check controller connection wirings; Check DC fuse.
Genset shutdown	Check the water/cylinder temperature is too high or not; Check the genset AC voltage; Check DC fuse.
Controller emergency stop	Check emergence stop button is correct or not; Check whether the starting battery positive be connected with the emergency stop input; Check whether the circuit is open.
Low oil pressure alarm after crank disconnect	Check the oil pressure sensor and its connections.
High water temp. alarm after crank disconnect	Check the temperature sensor and its connections.
Shutdown Alarm in running	Check related switch and its connections according to the information on VFD; Check programmable inputs.
Crank not disconnect	Check fuel oil circuit and its connections; Check starting batteries; Check speed sensor and its connections; Refer to engine manual.
Starter no response	Check starter connections; Check starting batteries.
Genset running while ATS not transfer	Check ATS; Check the connections between ATS and controllers.
RS485 communication is abnormal	Check connections; Check setting of COM port is correct or not; Check RS485's connections of A and B is reverse connect or not; Check RS485 transfer model whether damage or not; Check communication port of PC whether damage.